

Organizers

Cabinet Organizers

Storage with Style®	
Blind Corner Pullout NEW	330-331
Utensil Base Pullout NEW	332
Drawer Base Pullout	333
Base Pullout	334
Pot & Pan Organizer	335
Trash Can Pullout	336-337
Pullout Baskets	338-339
Waste Container Organization	
Wood Bottom Mount with Door Kit	342
Wood Bottom Mount	344
Metal Drawer Box Pullout NEW	345
Economy Soft-close Pullout NEW	346-347
Storage with Style® Trash Can Pullout	348-249
Wood Top Mount with Soft-close	350-351
Cans & Lids	352
Wire Bottom Mount	353
Base Cabinet Organization	
"No Wiggle" Pullout	357
"No Wiggle" Knife Block Pullout NEW	359
"No Wiggle" Utensil Pullout	360
"No Wiggle" Drawer Base Pullout	361
"No Wiggle" Tray Divider Pullout	362
"No Wiggle" Base Filler Pullouts	363
Peg Board Filler Pullout	364
Appliance Lift	365
Easy-to-Install Rollout Drawers	366-367
Build Your Own Rollouts	368
Quick Tray Pilaster System	369
Slide Mounting Kit for Ball Bearing Slides	370
Rear Mounting Bracket for undermount Slides	371
Dovetail Drawer Boxes & Linear Material	372-373
Bathroom Organization	
"No Wiggle" Vanity Pullout	380-381
Powered Vanity Drawer NEW	382-383
Wire Cleaning Supply Caddy	384
Wire Basket Rollout	385
Corner Organization	
Blind Corner Swingout	388-389
Blind Corner Sliding Door	390-391
Easy 360 Susan	392-393
Storage with Style® Blind Corner Pullout	394-395
Premium Wood Lazy Susan Kits	396-397
Premium Wood Lazy Susan Shelves & Poles	398-399
Premium Wood Swivel Lazy Susan	400
Economy Wire Swivel Lazy Susan	401
Economy Banded Swivel Lazy Susan	402
Economy Banded Lazy Susan Kits	403
Plastic Lazy Susan with Chrome Hub Kits	404
Economy Plastic Lazy Susan Kits	405
Plastic Pie-cut Lazy Susan	406
Half-moon Lazy Susan	407
Pantry Organization	
Premium Chrome Swingout	412-413
Premium Chrome Pullout	414
Wood Pullout	415
Wood Swingout	416
Wood Door Mount	417
Drawer Organization	
Peg Board Insert	420
Peg Board Accessories	421
Double Cutlery Drawer	422
Angled Cutlery Insert NEW	423
Cutlery Insert NEW	424-425

Knife Block Insert NEW	426
Spice Tray Insert NEW	x
Tipout Trays – Stainless Steel	428
Tipout Trays – White	429
Wall Cabinet Organization	
"No Wiggle" Wall Pullout	432
Wall Filler Pullout	433
Smart Rail® Storage Solution	434-437
Wire Tray Divider	438
Wooden Tray Divider	439
Door Mounted Spice Racks	440-441
Wooden Stemware Rack	442
Wooden Stemware Moulding	442
Wooden Bottle Lattice	443
Wire Stemware Rack	444
Wooden Bottle Rack	444

Easy-to-Install Organizers

Pullout Baskets	447
Trash Can Pullouts	448
Trash Cans & Lids	449
Cleaning Supply Caddy	450
Pullout Pot Organizer	451
Pullout Lid Organizer	452
Door Mounted Tray System	452
Single Shelf Lazy Susan	453
3-Tier Spice Pulldown	454
Over the Door Towel Bar	455
Tipout Trays	456
Under Cabinet Stemware Rack	457
Under Cabinet Bottle Rack	457
U-Shaped Tray Divider	458
3-Tier Dishcloth Rack	458

Closet Organizers

Shoe Fences	460
Pullout Baskets	461-463
Pullout Canvas Hamper	464
Pullout Plastic Hamper	465
Pullout Pant Rack	466
14" Belt & Tie Racks	467
Tri-Level Tie Organizer	468
Cascading Tie Organizer	469
12" Belt & Tie Racks, Valet Rod	470
Screw-Mount Racks	471
Telescoping Valet Rods	472
Jewelry Trays	473
Wardrobe Lifts	474-475
Laundry Valet	476
Hooks	477
Oval Closet Rods	478-479
Round Closet Rods	480-483
sempriaLED® Lighted Closet Rods	484-485
Lighted Closet Rod Profile NEW	486-487
Custom Dovetail Drawer Boxes	488-489
Shelf Supports	490-494
Heavy Duty Shelf Utility Bracket	494
Panel Connectors	495

What's New in Organizers?

STORAGE with STYLE[®]



Blind Corner Pullout

see page 330



Utensil Base Pullout

see page 332

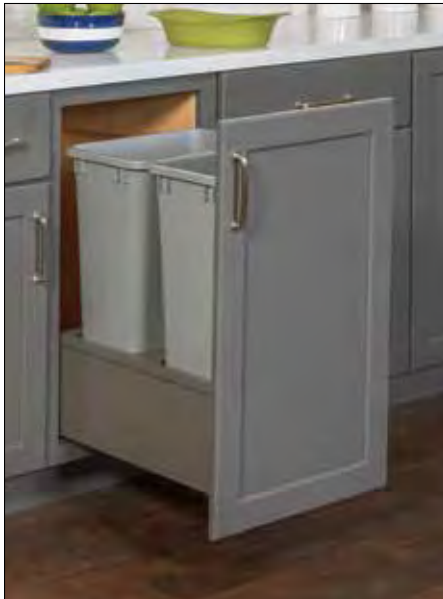

*Metal Drawer Box
Trashcan Pullout*

see page 345



*Economy Soft-Close
Trashcan Pullout*

see page 346



*"No Wiggle"
Knife Block Pullout*

see page 359

What's New in Organizers?



*Powered Vanity
Drawer Pullout*

see pages 382-383



*Angled Cutlery
Drawer Insert*

see page 423



*Cutlery
Drawer Insert*

see pages 424-425



*Knife Block
Drawer Insert*

see page 426



*Spice Rack
Drawer Insert*

see page 427

Maximize every inch



Drawer Solutions

Tame drawer clutter with our selection of drawer organizers. From complete drawer solutions to dividers, we help keep you organized from cutlery to pots and pans.



Pantry Solutions

Organize everyone's favorite spot in the kitchen with a Hardware Resources' pantry solution.



of kitchen storage



Pullout Solutions

Maximize your cabinet storage with our award-winning pullouts. From a base cabinet pullout to a utensil pullout to a vanity pullout, Hardware Resources helps you have a beautiful and organized kitchen.

Corner Solutions

Optimize what was once wasted space, and bring those impossible-to-reach items to your fingertips.



Waste Container Solutions

No more bending or reaching to dispose of trash. Keep unsightly waste hidden in the cabinet, yet easily accessible.

Cans sold separately.

PULLOUT SOLUTIONS

Maximize cabinet storage with Hardware Resources' base cabinet solutions. From cabinet pullouts to mixer lifts, we can help you make the most of a beautiful and organized kitchen.



**"No Wiggle"
Drawer Base Pullout**

Maximize storage under the drawer with our shortened height pullout. Keeps all items and spices secure with our "No Wiggle" platform.



**"No Wiggle" Pullout
The star of the kitchen!**

Bring your cabinet contents within easy reach. Our patented design eliminates the wiggle, keeping your contents secure.



"No Wiggle" Tray Divider Pullout

Tame cookie sheet chaos using easily accessible pullout divider with soft-close slides.



Appliance Lift

No more lifting heavy appliances thanks to this soft-close lift.



"No Wiggle" Utensil Pullout

Convenient storage of kitchen utensils with 4 stainless steel bins and extra storage on the bottom shelf.

WASTE CONTAINER SOLUTIONS



Premium Wood Top Mount Trash Can System

Low profile design, soft-closes into cabinet with mounted door.

Neatly tuck away trash cans with a Hardware Resources waste container solution. From top or bottom mount options to premium wood or economy wire, we have a solution that will enhance your design and optimize the budget.



Storage with Style® Trash Can Pullout

Tuck away trash cans in style with two trending finish options. See pages 330-339 for coordinating full product offering.



Economy Wire Trash Can System

Practical and versatile with three finish options.



Premium Wood Bottom Mount

Beautiful solid wood drawer box with concealed soft-close slides.



Premium Wood Bottom Mount with Door Kit

Beautiful solid wood drawer box with concealed soft-close slides and patented door mounting system.

PANTRY SOLUTIONS

Organize everyone's favorite spot in the kitchen with a Hardware Resources pantry solution. From the traditional pantry pullout to our innovative pantry swingout, we have a solution for pantry storage needs.



Premium Chrome Swingout

Pivots 90 degrees when fully extended, making the back of the pantry easily accessible.



Wood Swingout & Door Mount

Maximize pantry storage with swinging shelves and door mount shelves.



Premium Wood Pullout

Natural solid wood pullout on heavy-duty slides.



Premium Chrome Pullout

Heavy-duty soft-close pantry pullout with stylish chrome accents.

DRAWER SOLUTIONS

Tame drawer clutter with Hardware Resources' drawer organizers. From complete drawer solutions to drop-in inserts, these products will help organize everything from cutlery to cookware.



Pegboard Organizer Cookware and Lid Insert

Works in conjunction with Pegboard Organizer Insert to organize cookware in deep drawers.



Double Cutlery Drawer

Double your drawer space with our two-tier cutlery drawer; top cutlery drawer slides away revealing bottom cutlery drawer.



Pegboard Organizer Insert

Beautiful solid wood pegboard drops into drawer for customizable organization.



Spice Tray Drawer Insert

Tiered and tilted design allows you to easily see your spices.



Angled Large Cutlery Drawer Insert

Beautiful natural wood divider, simply drops into drawer.



Knife Block Drawer Insert

Get your knife block off the counter and into your drawer with this knife block insert.

CORNER SOLUTIONS

With Hardware Resources' blind corner solutions, previously unused cabinet space is a thing of the past. The variety of options available ensures that we have a solution that will fit your design and style.



Also available in white plastic

HMLS-W-3212
Page 407

Half-Moon Lazy Susan

Shelves pivot then slide out for full access in hard to reach blind corners. Available in wood and plastic options to meet any budget.



PLSK232
Page 404

Plastic Lazy Susan

Functional and practical corner solution.



LSR218-SET
Pages 396-397

Premium Wood Lazy Susan

Timeless traditional lazy susan that features beautiful wood and chrome accents.



BCS0215PCMP-LH
Pages 388-389

Blind Corner Swingout

Double shelves that independently pull out of the cabinet allow easy access to the back of the cabinet.



SWS-BCS15BN
Pages 330-331

Storage with Style® Blind Corner Pullout

With a universal design for left or right-hand blind corners, all four baskets pull out of the cabinet for full access of your cabinet.

WALL STORAGE SOLUTIONS

Maximize cabinet storage with Hardware Resources' wall cabinet solutions. From cabinet pullouts and bakeware organizers to spice racks and wine accessories, we can help you make the most beautiful and organized kitchen.



SR30 & WR36MP
Pages 442 & 443

Bottle Lattice and Stemware Rack

Showcase your wine collection with a beautiful wine bottle wooden lattice rack and coordinating stemware rack.



WP02
Page 432

Upper Cabinet Pullouts

Pullout shelves keep everything within your reach.



SRSS999-LED, SRSS930-BAM
& SRSS900-BAM
Pages 434-437

Smart Rail System

Put your walls to work with this versatile modular storage system.



SPR9A
Pages 440-441

Door Mount Spice Racks

Maximize your space by adding storage on your cabinet door, freeing up shelf space.

Easy-Install Kitchen Organizers are

After cabinets have been ordered and even after cabinets have been installed, your customer may want to add additional Organizers to their new cabinets. Below are professional-grade Organizers that are easy to install after the cabinets have been made, designed to fit standard 1-1/2" face frame cabinets.



Bottom Mount Trash Can Pullouts

Install quickly with
just a few screws

See page 342



Smart Rail™

Customizable hanging
storage solution

See pages 434-437



Tray Dividers

Keep trays and bakeware
in easy reach

See pages 438-439



Drawer Inserts

Organize plates, bowls,
pots, lids, knives,
cutlery, spices

See pages 420-427



Shelf-Mounted Rollout Drawers

Bring back of cabinet
storage to your fingertips

See pages 366-368



Lazy Susans

Single shelf lazy susans
rotate 360 degrees and
install on a shelf

See page 400-407

ideal for after cabinets are in place



Look for this logo throughout our Organizer Selection for items that are easy to install after the cabinets are in place



Wall Cabinet Pullouts

Organize wall cabinets for foodstuffs and kitchen gadgets

See page 432



Door Mounted Spice Racks

2 styles available. Reclaim the cabinet door for storage

See pages 440-441



Wire Stemware Rack

Install this rack under wall cabinets with just 2 screws

See page 442



Tipout Trays

No more false drawers in front of sinks

See pages 428-429

ALSO AVAILABLE:

See our full line of easy-to-install 11 Minute Organizers, ideal for the DIY customer, on pages 447-458



Cleaning Supply Caddy

Organize cleaning supplies in this portable rollout basket

See page 450



Pullout Pot & Lid Organizers

Store cookware within reach, easily installs with just 4 screws

See page 452

Video Resources



Organizer Benefits Video

Show your customers how they can incorporate organizers into their dream kitchens by showing this video either on our website (www.HardwareResources.com), our Vimeo account (<https://vimeo.com/HardwareResources>) or download for use on your showroom TVs.

Scan to watch the benefits video
<http://delivr.com/24FXP>



Installation Videos

Installation videos for many of our organizers can be found on our website and also on our Vimeo channel.

Scan to watch the installation video
<http://delivr.com/2fz83>



Video Resources

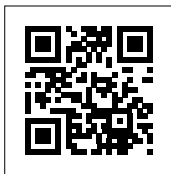

Organizers Overview
vimeo.com/154315251



Some things shouldn't wiggle (BPO2)
vimeo.com/181622344



No Wiggle Pullout (BPO2) Comparison Video
vimeo.com/179339278



No Wiggle Pullout (BPO2) Installation + Tips Video
vimeo.com/180934686

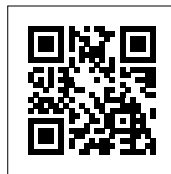

Blind Corner Swingout (BCSO) Installation Video
vimeo.com/217732515



Blind Corner Pullout (CS-SHM) Installation Video
vimeo.com/138979481

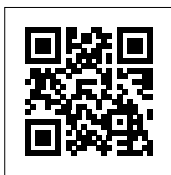

Sliding Door Corner Organizer (CS-SDCO) Installation Video
vimeo.com/138977318



Easy Susan (CS-ES360) Installation Video
vimeo.com/138980424

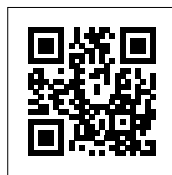

Round Lazy Susan Kit with Twist & Lock Pole (LSR2) Installation Video
vimeo.com/198414071



Kidney Lazy Susan Kit with Twist & Lock Pole (LSK2) Installation Video
vimeo.com/198413723



Single Shelf Lazy Susans (LSK-S) Installation Video
vimeo.com/198413388



Round Plastic Lazy Susans with Twist & Lock Pole (PLS) Installation Video
vimeo.com/166805283

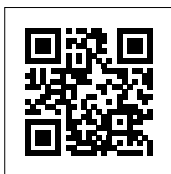

Economy Banded Lazy Susan Kits (BLSR2) Installation Video
vimeo.com/107958473

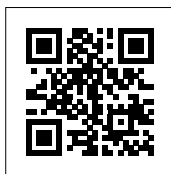

Plastic Lazy Susans with Chrome Hubs and Twist & Lock Pole (PLSM) Installation Video
vimeo.com/198411317

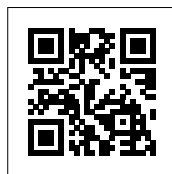

Economy Plastic Lazy Susans with Twist & Lock Pole (PLSR2) Installation Video
vimeo.com/198410221



Pie-cut Lazy Susan Installation Video
vimeo.com/246822235



Half-moon Lazy Susan Installation Video
vimeo.com/238951023



Top Mount Trash Can System (CAN-TM) Installation Video
vimeo.com/138980671



Wood Bottom Mount Trash Can System (CAN-WBM) Installation Video
vimeo.com/198411837

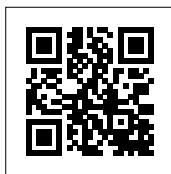

Wood Bottom Mount Trash Can System with Door Brackets (CDM-WBM) Installation Video
vimeo.com/198413216



Chrome Pantry Pullout (CPPO) Installation Video
vimeo.com/138979659



Chrome Pantry Swingout (CPSO) Installation Video
vimeo.com/138979839



Wood Pantry Swingout & Door Mount (PSO & PDM) Installation Video
vimeo.com/138980578

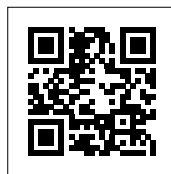

Wood Pantry Pullout (PPO2) Installation Video
vimeo.com/198408615

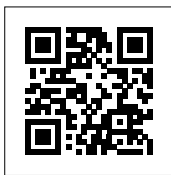

Double Cutlery Drawer (CD15) Installation Video
vimeo.com/138980141



Rollouts and Highbacks Product Overview Video
vimeo.com/124835512

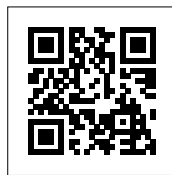

Appliance/Mixer Lift (ML-1) Installation Video
vimeo.com/224538954

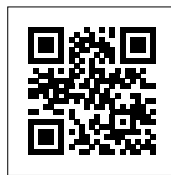

SWS Pot/Lid Installation Video
vimeo.com/248331955



SWS Trash Can Installation Video
vimeo.com/248331963



SWS Baskets Installation Video
vimeo.com/294441085

STORAGE with STYLE[®]

Storage solutions that beautifully coordinate to create a harmonious kitchen design

..... Drawer Base Pullout

..... Blind Corner Pullout

..... Trash Can Pullout

Storage with Style® is a designer organizer collection that beautifully coordinates to create a harmonious kitchen design. Add storage solutions to your kitchen with a trashcan pullout, spice pullouts, utensil pullouts, pan organizer, and pullout baskets; all designed to coordinate for a cohesive look and eliminate reaching inside a cabinet.



Design is in the details

Curved flat wire design details flow across all organizers to create a cohesive collection identity



Stylish finish options

Designer finishes of Black Nickel and Polished Chrome coordinate with popular hardware styles, or mix finishes to add variety



Base Pullout

Pot & Lid Organizer

Pullout Basket



NEW Blind Corner Pullout

All four baskets slide and pull out of the corner cabinet opening for full access

Metal baskets are adjustable in height

Universal design for left or right-hand blind corners

Available in standard and full-height blind corner cabinets.
For full-height option, additional baskets can be added to make a three-tiered organizer (see at right)

Includes heavy-duty soft-close slides for smooth movement in and out of the cabinet (preinstalled)

Heavy-duty frame construction ensures organizer is stable when in motion

Acrylic liners add stability to baskets and are easy to clean





Black Nickel



Polished Chrome

Description	Item Number	Frame Color	Width	Depth	Height	Standard Cabinet Size	Weight Capacity	Ctn Qty
Blind Corner Organizer for Standard Height 15" Opening	SWS-BCS15BN	Black Nickel	26-13/16"	22-1/8"	20-9/16"	Blind Corner with drawer	130 lb	1
	SWS-BCS15PC	Polished Chrome	26-13/16"	22-1/8"	20-9/16"	Blind Corner with drawer	130 lb	1
Blind Corner Organizer for Standard Height 18" Opening	SWS-BCS18BN	Black Nickel	32-7/8"	22-1/8"	20-9/16"	Blind Corner with drawer	130 lb	1
	SWS-BCS18PC	Polished Chrome	32-7/8"	22-1/8"	20-9/16"	Blind Corner with drawer	130 lb	1
Blind Corner Organizer for Full Height 15" Opening	SWS-BCFH15BN	Black Nickel	26-13/16"	22-1/8"	24-1/16"	Blind Corner - full height door	130 lb	1
	SWS-BCFH15PC	Polished Chrome	26-13/16"	22-1/8"	24-1/16"	Blind Corner - full height door	130 lb	1
Blind Corner Organizer for Full Height 18" Opening	SWS-BCFH18BN	Black Nickel	32-7/8"	22-1/8"	24-1/16"	Blind Corner - full height door	130 lb	1
	SWS-BCFH18PC	Polished Chrome	32-7/8"	22-1/8"	24-1/16"	Blind Corner - full height door	130 lb	1
Pair of Extra Baskets for SWS-BCFH15 15" Opening	SWS-BCBAS15BN	Black Nickel	12-3/16"	15-9/16"	3-9/16"	-	25 lb	1
	SWS-BCBAS15PC	Polished Chrome	12-3/16"	15-9/16"	3-9/16"	-	25 lb	1
Pair of Extra Baskets for SWS-BCFH18 18" Opening	SWS-BCBAS18BN	Black Nickel	15-3/16"	15-9/16"	3-9/16"	-	25 lb	1
	SWS-BCBAS18PC	Polished Chrome	15-3/16"	15-9/16"	3-9/16"	-	25 lb	1

Recommended screw:

screws included

*Full height door required

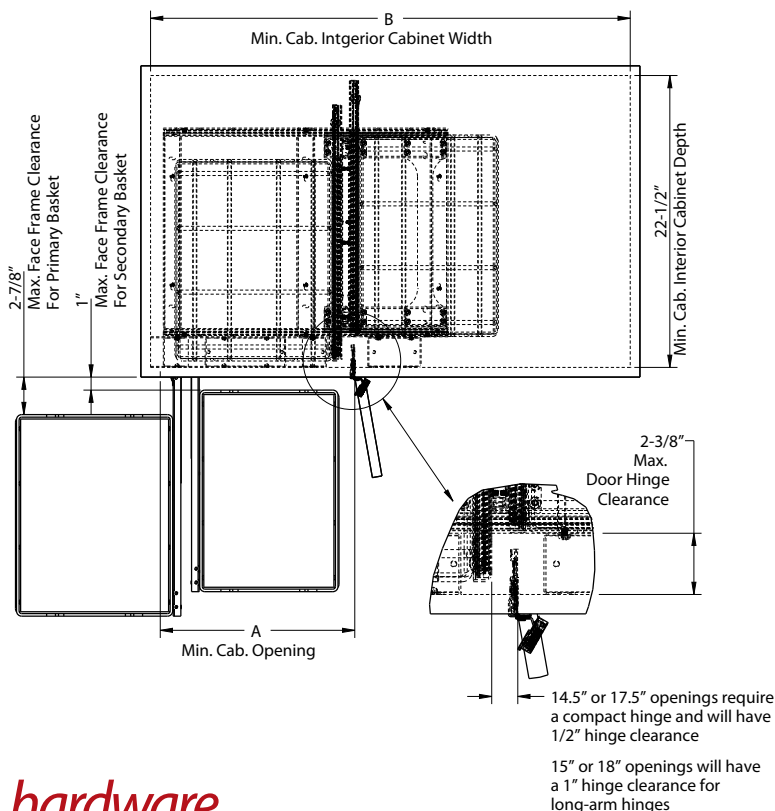

Door Opening Height

	Height	A	B
SWS-BCS15BN	20-9/16"	14-1/2"	27"
SWS-BCS15PC	20-9/16"	14-1/2"	27"
SWS-BCS18BN	20-9/16"	17-1/2"	33"
SWS-BCS18PC	20-9/16"	17-1/2"	33"
SWS-BCFH15BN	24-1/16"	14-1/2"	27"
SWS-BCFH15PC	24-1/16"	14-1/2"	27"
SWS-BCFH18BN	24-1/16"	17-1/2"	33"
SWS-BCFH18PC	24-1/16"	17-1/2"	33"



SHIPS FULLY ASSEMBLED

NEW Utensil Base Pullout

- Convenient storage for kitchen utensils
- Includes 4 stainless steel bins that are easy to remove for cleaning
- Open bottom shelf for additional storage
- Integrated, patented, 6-way adjustable door mounting brackets
- "No Wiggle" patented hardware eliminates excessive sag and side-to-side movement
- Smooth, soft-closing slides (preinstalled)
- Removable grey acrylic liners for easy cleaning
- Ships fully assembled and ready to install



PATENTED
9,723,922

Optional 6-way adjustable door mounting brackets included



Polished Chrome



Black Nickel

	Description	Frame Color	Width	Depth	Height	Min. Opening	Standard Cab. Size	Weight Capacity	Ctn Qty
SWS-UBPO8BN	8" Wire Base Pullout	Black Nickel	8-15/16"	21-5/16"	24-1/16"	8-1/2"	12" base or larger	100 lb	1
SWS-UBPO8PC	8" Wire Base Pullout	Polished Chrome	8-15/16"	21-5/16"	24-1/16"	8-1/2"	12" base or larger	100 lb	1

Recommended screw:

screws included



SHIPS FULLY ASSEMBLED



Scan to watch the installation video
<https://delivr.com/2eyqn>

Drawer Base Pullout

- Reduced height to use in a standard cabinet under a drawer.
- Integrated, patented, 6-way adjustable door mounting brackets
- "No Wiggle" patented hardware eliminates excessive sag and side-to-side movement
- Smooth, soft-closing slides (preinstalled)
- One adjustable shelf included
- Removable grey acrylic liners for easy cleaning
- Ships fully assembled and ready to install

U.S. PATENTED
 9,723,922

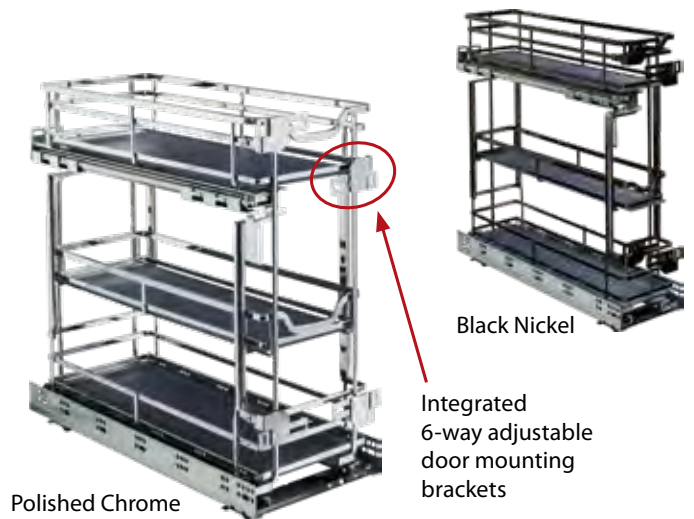

Polished Chrome

Black Nickel

Integrated 6-way adjustable door mounting brackets

	Description	Frame Color	Width	Depth	Height	Min. Opening	Standard Cab. Size	Weight Capacity	Ctn Qty
SWS-DBPO5BN	5" Wire Drawer Base Pullout	Black Nickel	5-15/16"	21-5/16"	20-1/4"	5"	9" base or larger	100 lb	1
SWS-DBPO5PC	5" Wire Drawer Base Pullout	Polished Chrome	5-15/16"	21-5/16"	20-1/4"	5"	9" base or larger	100 lb	1
SWS-DBPO8BN	8" Wire Drawer Base Pullout	Black Nickel	8-15/16"	21-5/16"	20-1/4"	9"	12" base or larger	100 lb	1
SWS-DBPO8PC	8" Wire Drawer Base Pullout	Polished Chrome	8-15/16"	21-5/16"	20-1/4"	9"	12" base or larger	100 lb	1

Recommended screw:

screws included



Base Pullout

Integrated, patented*, 6-way adjustable door mounting brackets

"No Wiggle" patented* hardware eliminates excessive sag and side-to-side movement

Smooth, soft-closing slides (preinstalled)

Middle shelf is adjustable

Removable grey acrylic liners for easy cleaning

Ships fully assembled and ready to install

Requires full height cabinet door



Polished Chrome

Black Nickel

	Description	Frame Color	Width	Depth	Height	Min. Opening	Standard Cab. Size	Weight Capacity	Ctn Qty
SWS-BPO5BN	5" Wire Base Pullout	Black Nickel	5-15/16"	21-5/16"	24-1/16"	6"	9" base or larger	100 lb	1
SWS-BPO5PC	5" Wire Base Pullout	Polished Chrome	5-15/16"	21-5/16"	24-1/16"	6"	9" base or larger	100 lb	1
SWS-BPO8BN	8" Wire Base Pullout	Black Nickel	8-15/16"	21-5/16"	24-1/16"	9"	12" base or larger	100 lb	1
SWS-BPO8PC	8" Wire Base Pullout	Polished Chrome	8-15/16"	21-5/16"	24-1/16"	9"	12" base or larger	100 lb	1

Recommended screw:

screws included

STORAGE with STYLE®



 **SHIPS FULLY ASSEMBLED**



Scan to watch the installation video
<http://delivr.com/23y5t>

Pot & Lid Organizer Pullout

Designed to prevent pans from banging together, keeping them from being damaged and preventing unwanted noise

Top mounting, leaves bottom of the cabinet accessible for additional storage

Hooks are adjustable for full customization

Integrated lid storage

Smooth, soft-closing slides

Ships fully assembled and installs with just four screws

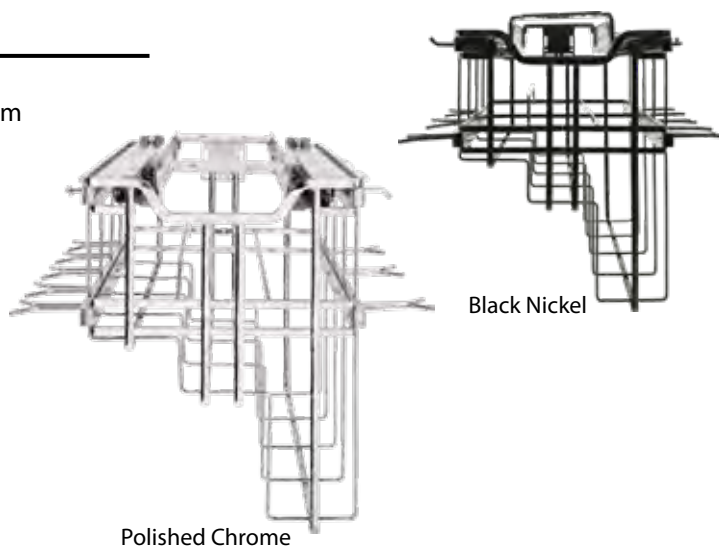

	<i>Frame Color</i>	<i>Width</i>	<i>Depth</i>	<i>Height</i>	<i>Min. Opening</i>	<i>Standard Cab. Size</i>	<i>Weight Capacity</i>	<i>Ctn Qty</i>
SWS-PO21BN	Black Nickel	15-5/8"	22-5/8"	13-7/16"	15-5/8"	24" base or larger	100 lb	1
SWS-PO21PC	Polished Chrome	15-5/8"	22-5/8"	13-7/16"	15-5/8"	24" base or larger	100 lb	1

Recommended screw:

screws included

STORAGE with STYLE®



Scan to watch the
installation video
<http://delivr.com/2cjqh>





Trash Can Pullout

Ships fully assembled with trashcan(s) available in 3 configurations:
double can 35 qt, double can 50 qt, and single can 35 qt

Integrated, patented*, 6-way adjustable door mounting brackets

"No Wiggle" patented* hardware eliminates
excessive sag and side-to-side movement

Smooth, soft-closing slides (preinstalled)

Removable grey acrylic liners for easy cleaning

Installs with just four screws



PATENTED
9,723,922
& D876,094



Integrated
6-way adjustable
door mounting
brackets

Polished Chrome

	Description	Frame Color	Can Color	Width	Depth	Height	Min. Opening	Standard Cab. Size	Weight Capacity	Ctn Qty
SWS-MBMS35GBN	Single 35 qt	Black Nickel	Grey	12"	21-13/16"	20"	12"	15" base	100 lb	1
SWS-MBMS35GPC	Single 35 qt	Polished Chrome	Grey	12"	21-13/16"	20"	12"	15" base	100 lb	1
SWS-MBMD35GBN	Double 35 qt	Black Nickel	Grey	14-15/16"	21-13/16"	20"	15"	18" base	100 lb	1
SWS-MBMD35GPC	Double 35 qt	Polished Chrome	Grey	14-15/16"	21-13/16"	20"	15"	18" base	100 lb	1
SWS-MBMD50GBN	Double 50 qt	Black Nickel	Grey	14-15/16"	21-13/16"	24"	15"	18" base	100 lb	1
SWS-MBMD50GPC	Double 50 qt	Polished Chrome	Grey	14-15/16"	21-13/16"	24"	15"	18" base	100 lb	1

Recommended screw:

screws included



SHIPS FULLY
ASSEMBLED



Scan to watch the
installation video
<https://delivr.com/2eyqn>

Pullout Basket & Pilaster System

Can be bottom mounted or side-mounted for face frame or frameless application

Stack multiple baskets with optional pilaster system

Smooth, soft-closing slides

Sleek, modern metal design

Available in two finishes:

Polished Chrome & Black Nickel

Removable grey acrylic liners for easy cleaning

*US Patents pending



SWS-WB273BN
Black Nickel



SWS-WB213PC
Polished Chrome



	<i>Description</i>	<i>Frame Color</i>	<i>Width</i>	<i>Depth</i>	<i>Height</i>	<i>Min. Opening</i>	<i>Standard Cab. Size</i>	<i>Weight Capacity</i>	<i>Ctn Qty</i>
SWS-WB153BN	Wire Pullout Basket	Black Nickel	14-1/2"	22-1/16"	4-1/4"	14-1/2"	18" base	100 lb	1
SWS-WB153PC	Wire Pullout Basket	Polished Chrome	14-1/2"	22-1/16"	4-1/4"	14-1/2"	18" base	100 lb	1
SWS-WB213BN	Wire Pullout Basket	Black Nickel	20-7/16"	22-1/16"	5-7/16"	20-1/2"	24" base	100 lb	1
SWS-WB213PC	Wire Pullout Basket	Polished Chrome	20-7/16"	22-1/16"	5-7/16"	20-1/2"	24" base	100 lb	1
SWS-WB273BN	Wire Pullout Basket	Black Nickel	26-5/16"	22-1/16"	5-7/16"	26-1/2"	30" base	100 lb	1
SWS-WB273PC	Wire Pullout Basket	Polished Chrome	26-5/16"	22-1/16"	5-7/16"	26-1/2"	30" base	100 lb	1
SWS-PILKITBN	Pilaster System	Black Nickel	1-1/4"	8/16"	21-1/2"	-	-	-	1
SWS-PILKITPC	Pilaster System	Polished Chrome	1-1/4"	8/16"	21-1/2"	-	-	-	1

Recommended screw:

screws included

WASTE CONTAINER ORGANIZATION



Storage with Style® Trash Can Pullout
Pages 336-337



Storage with Style® Trash Can Pullout
Pages 336-337



Premium Wood Top Mount with Soft-close
Page 350-351

Waste Container Organization

Neatly tuck away trash cans with a Hardware Resources waste container solution. From top or bottom mount options to premium wood or economy wire, we have a solution that will enhance your design and optimize the budget.



Premium Wood Bottom Mount
Page 344

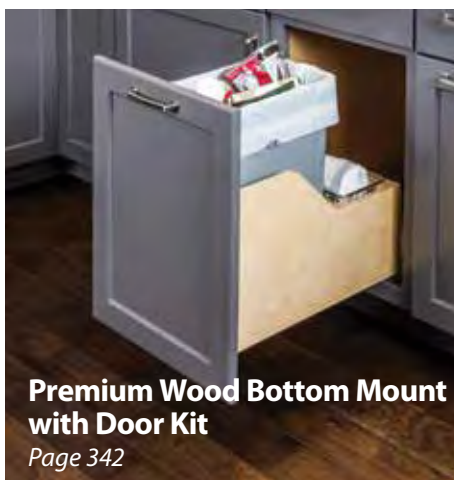

**Premium Wood Bottom Mount
with Door Kit**
Page 342

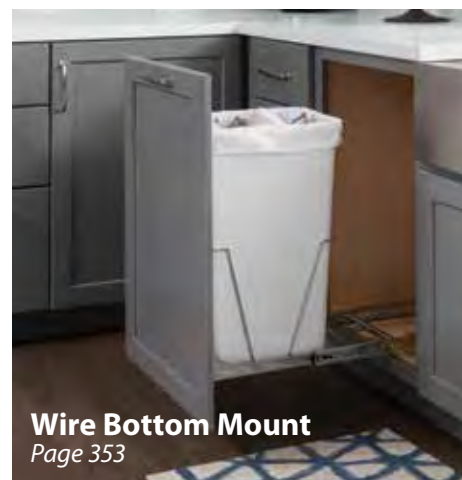

Wire Bottom Mount
Page 353

Waste Container Organization: Wood Bottom Mount with Door Kit



Designed for cabinets with 12" (single can) or 15" (double can) minimum opening width

Features patented 6-way adjustable door mounting brackets for ease of door installation

Ships fully preassembled and quickly mounts to cabinet floor using four screws

Features 100 lb full extension soft-closing concealed undermount slides

UV coated edgebanded birch plywood construction

Ships with one or two heavy duty polymer trash cans in 35 qt or 50 qt and in black, white or grey finishes.

Note: full height base cabinet needed if using 50 qt trash cans



PATENTED

9,661,924
& 10,028,581

Scan to watch the installation video
<http://delivr.com/2RSTV>



	Description	Can Color	Width	Depth	Height	Min. Opening	Standard Cab. Size	Weight Capacity	Ctn Qty
CDM-WBMS35B	Single 35 qt	Black	12"	21-3/8"	19-3/4"	11-1/2"	15" base	100 lb	1
CDM-WBMS35WH	Single 35 qt	White	12"	21-3/8"	19-3/4"	11-1/2"	15" base	100 lb	1
CDM-WBMS35G	Single 35 qt	Grey	12"	21-3/8"	19-3/4"	11-1/2"	15" base	100 lb	1
CDM-WBMD35B	Double 35 qt	Black	15"	21-3/8"	19-3/4"	14-1/2"	18" base	100 lb	1
CDM-WBMD35WH	Double 35 qt	White	15"	21-3/8"	19-3/4"	14-1/2"	18" base	100 lb	1
CDM-WBMD35G	Double 35 qt	Grey	15"	21-3/8"	19-3/4"	14-1/2"	18" base	100 lb	1
CDM-WBMS50B	Single 50 qt	Black	12"	21-3/8"	24"	11-1/2"	15" base	100 lb	1
CDM-WBMS50WH	Single 50 qt	White	12"	21-3/8"	24"	11-1/2"	15" base	100 lb	1
CDM-WBMS50G	Single 50 qt	Grey	12"	21-3/8"	24"	11-1/2"	15" base	100 lb	1
CDM-WBMD50B	Double 50 qt	Black	15"	21-3/8"	24"	15"	18" base	100 lb	1
CDM-WBMD50WH	Double 50 qt	White	15"	21-3/8"	24"	15"	18" base	100 lb	1
CDM-WBMD50G	Double 50 qt	Grey	15"	21-3/8"	24"	15"	18" base	100 lb	1

Recommended screw:

screws included



What makes a great trash can pullout?



Cans available in 2 sizes and 3 colors

UV Coated White Birch material

Dovetail joints

Ships fully assembled & quickly mounts to cabinet floor with 4 screws

Concealed soft-close slides included (pre-installed)

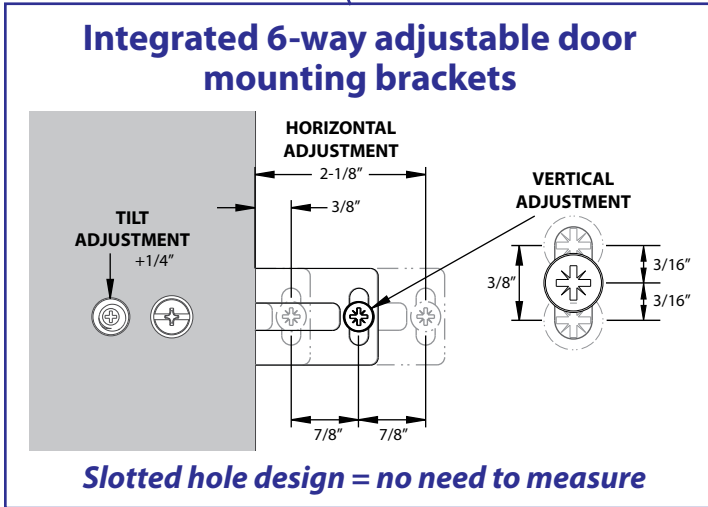

Patented mounting hardware
US Patents 9,661,924 & 10,028,581

Waste Container Organization: Wood Bottom Mount



Ships fully preassembled and quickly mounts to cabinet floor using four screws

Designed for cabinets with 12" (single can) or 15" (double can) minimum opening width

Features 100 lb full extension soft-closing concealed undermount slides (pre-installed)

UV coated edgebanded birch plywood construction

Single unit includes chrome-plated wire basket for storage of trash bags

Ships with one or two heavy duty polymer trash cans in 35 qt or 50 qt and in black, white or grey finishes.

Note: full height base cabinet needed if using 50 qt trash cans



Scan to watch the installation video
<http://delivr.com/2V2YC>

	Description	Can Color	Width	Depth	Height	Min. Opening	Standard Cab. Size	Weight Capacity	Ctn Qty
CAN-WBMS35B	Single 35 qt	Black	12"	21-3/8"	19-3/4"	11-1/2"	15" base	100 lb	1
CAN-WBMS35WH	Single 35 qt	White	12"	21-3/8"	19-3/4"	11-1/2"	15" base	100 lb	1
CAN-WBMS35G	Single 35 qt	Grey	12"	21-3/8"	19-3/4"	11-1/2"	15" base	100 lb	1
CAN-WBMD35B	Double 35 qt	Black	15"	21-3/8"	19-3/4"	15"	18" base	100 lb	1
CAN-WBMD35WH	Double 35 qt	White	15"	21-3/8"	19-3/4"	15"	18" base	100 lb	1
CAN-WBMD35G	Double 35 qt	Grey	15"	21-3/8"	19-3/4"	15"	18" base	100 lb	1
CAN-WBMS50B	Single 50 qt	Black	12"	21-3/8"	24"	11-1/2"	15" base	100 lb	1
CAN-WBMS50WH	Single 50 qt	White	12"	21-3/8"	24"	11-1/2"	15" base	100 lb	1
CAN-WBMS50G	Single 50 qt	Grey	12"	21-3/8"	24"	11-1/2"	15" base	100 lb	1
CAN-WBMD50B	Double 50 qt	Black	15"	21-3/8"	24"	14-1/2"	18" base	100 lb	1
CAN-WBMD50WH	Double 50 qt	White	15"	21-3/8"	24"	14-1/2"	18" base	100 lb	1
CAN-WBMD50G	Double 50 qt	Grey	15"	21-3/8"	24"	14-1/2"	18" base	100 lb	1

Recommended screw: screws included



Waste Container Organization: Metal Drawer Box Trash Can Pullout



Hide trash in plain sight with this modern grey trash can pullout

Designed to fit standard 1-1/2" faceframe openings with a clean, metal wall design

Thin 7" height double wall metal drawer box maximizes cabinet space allowing for a single can pullout to fit in a 12" cabinet opening and the double can units to fit in a 15" cabinet opening

Ships fully preassembled and quickly mounts to cabinet floor using four screws

Ships with one or two heavy duty polymer trash cans in 35 qt or 50 qt and in a grey finish.

Integrated door brackets with vertical and horizontal adjustment

Smooth soft-closing synchronized slides with 100lb dynamic capacity (uninstalled)

Note: full height base cabinet needed if using 50 qt trash cans



	Description	Can Color	Width	Depth	Height	Min. Opening	Standard Cab. Size	Weight Capacity	Ctn Qty
CAN-MDB5-S35G	Single 35 qt	Grey	12"	21"	20"	12"	15" base	100 lb	1
CAN-MDB5-D35G	Double 35 qt	Grey	15"	21"	20"	15"	18" base	100 lb	1
CAN-MDB5-D50G	Double 50 qt	Grey	15"	21"	24"	15"	18" base	100 lb	1

Recommended screw: screws included

Waste Container Organization: Economy Soft-close Trash Can Pullout

NEW

Introducing 4 new budget-friendly options that don't compromise on features or quality.



WC-EMBM-D50G | 50 qt Double Can



WC-EMBM-S35G | 35 qt Single Can

35 qt configurations
fit in under-drawer
base cabinets



WC-EMBM-D35G | 35 qt Double Can

50 qt configurations
fit in full-height
base cabinets

Designed for cabinets with 12" (single can) or 15" (double can) minimum opening width
 Features patented 6-way adjustable door mounting brackets for ease of door installation
 Ships fully preassembled and quickly mounts to cabinet floor using four screws
 Features 100 lb full extension soft-closing concealed undermount slides (pre-installed)
 UV coated edgebanded birch plywood construction
 Ships with one or two heavy duty polymer trash cans in 35 qt or 50 qt and in black, white or grey finishes



PATENTED

9,661,924
 & 10,028,581

Note: full height base cabinet needed if using 50 qt trash cans

Item Number	Description	Width	Depth	Height	Min Opening Width	Standard Cabinet Size	Weight Capacity	Ctn Qty
WC-EMBM-S35G	Single 35 qt	11-1/2"	21-13/16"	20-5/8"	11-1/2"	15" base	100 lb	1
WC-EMBM-S50G	Single 50 qt	11-1/2"	21-13/16"	24-13/16"	11-1/2"	15" base	100 lb	1
WC-EMBM-D35G	Double 35 qt	14-1/4"	21-13/16"	20-5/8"	14-1/2"	18" base	100 lb	1
WC-EMBM-D50G	Double 50 qt	14-5/8"	21-13/16"	24-13/16"	15"	18" base	100 lb	1

Recommended screw:

screws included



WC-EMBM-S50G | 50 qt Single Can



WC-EMBM-D50G | 50 qt Double Can

Single Can Configurations

35 qt can

50 qt can

Double Can Configurations

35 qt cans

50 qt cans



WC-EMBM-S35G



WC-EMBM-S50G



WC-EMBM-D35G



WC-EMBM-D50G



Scan to watch the
installation video
<http://delivr.com/2cjgh>



SHIPS FULLY
ASSEMBLED



Trash Can Pullout

Ships fully assembled with trashcan(s) available in 3 configurations:
double can 35 qt, double can 50 qt, and single can 35 qt

Integrated, patented, 6-way adjustable door mounting brackets

“No Wiggle” patented hardware eliminates
excessive sag and side-to-side movement

Smooth, soft-closing slides (preinstalled)

Removable grey acrylic liners for easy cleaning

Installs with just four screws



PATENTED
9,723,922
& D876,094



Integrated
6-way adjustable
door mounting
brackets

Polished Chrome

	Description	Frame Color	Can Color	Width	Depth	Height	Min. Opening	Standard Cab. Size	Weight Capacity	Ctn Qty
SWS-MBMS35GBN	Single 35 qt	Black Nickel	Grey	12"	21-13/16"	20"	12"	15" base	100 lb	1
SWS-MBMS35GPC	Single 35 qt	Polished Chrome	Grey	12"	21-13/16"	20"	12"	15" base	100 lb	1
SWS-MBMD35GBN	Double 35 qt	Black Nickel	Grey	14-15/16"	21-13/16"	20"	15"	18" base	100 lb	1
SWS-MBMD35GPC	Double 35 qt	Polished Chrome	Grey	14-15/16"	21-13/16"	20"	15"	18" base	100 lb	1
SWS-MBMD50GBN	Double 50 qt	Black Nickel	Grey	14-15/16"	21-13/16"	24"	15"	18" base	100 lb	1
SWS-MBMD50GPC	Double 50 qt	Polished Chrome	Grey	14-15/16"	21-13/16"	24"	15"	18" base	100 lb	1

Recommended screw:

screws included

Waste Container Organization: Wood Top Mount with Soft-close



Cans Sold Separately
See page 353

- Features 100 lb soft-close ball bearing slides (pre-installed)
- Self-adjusting back brackets included for face-frame application
- Included trash can ring allows for use with either a 35 qt or 50 qt can*
- Door mounting bracket included with horizontal and vertical adjustments
- Single can units come with a stainless steel basket to hold trash bags
- Solid white birch construction with clear UV finish

Cans sold separately (see page 353)

Note: full height base cabinet needed if using 50 qt trash cans



! 15" double 35 qt fits in 15" opening and can be mounted using patented* 6-way adjustable mounting brackets under a drawer

*US Patent Pending

	Description	Width	Depth	Height*	Min. Opening	Standard Cab. Size	Weight Capacity	Ctn Qty
CAN-TMSC-12	Single 35 qt or 50 qt	12"	21-5/8"	3-1/4"	12"	15" base	100 lb	1
CAN-TMSC-15	Single 35 qt or 50 qt	15"	21-5/8"	3-1/4"	15"	18" base	100 lb	1
CAN-TMDSC-15	Double 35 qt	15"	21-3/4"	8-9/16"	15"	18" base	90 lb	1
CAN-TMDSC-18	Double 35 qt or 50 qt	18"	21-5/8"	3-1/4"	18"	21" base	90 lb	1
CAN-TMDSC-21	Double 35 qt or 50 qt	21"	21-5/8"	3-1/4"	21"	24" base	90 lb	1

Recommended screw: #8 flat head

Height does not include cans. Height with can is same as can height. See page 352 for cans.

*Trash can ring not included for CAN-TMDSC-15.



Waste Container Organization: Wood Top Mount with Soft-Close & Cans

Now available with cans included!

Comes in all finishes and sizes, just order one part number to get all components needed.

SKU	Description	Width	Depth	Height	Min. Opening	Standard Cab. Size	Weight Capacity	Ctn Qty
CAN-TMS1235B-K	Single 35 qt - Black can	12"	21-5/8"	18"	12"	15" base	100 lb	1
CAN-TMS1235G-K	Single 35 qt - Grey can	12"	21-5/8"	18"	12"	15" base	100 lb	1
CAN-TMS1235W-K	Single 35 qt - White can	12"	21-5/8"	18"	12"	15" base	100 lb	1
CAN-TMS1250B-K	Single 50 qt - Black can	12"	21-5/8"	22-1/4"	12"	15" base	100 lb	1
CAN-TMS1250G-K	Single 50 qt - Grey can	12"	21-5/8"	22-1/4"	12"	15" base	100 lb	1
CAN-TMS1250W-K	Single 50 qt - White can	12"	21-5/8"	22-1/4"	12"	15" base	100 lb	1
CAN-TMD1535B-K	Double 35 qt - Black cans	15"	21-3/4"	18"	15"	18" base	100 lb	1
CAN-TMD1535G-K	Double 35 qt - Grey cans	15"	21-3/4"	18"	15"	18" base	100 lb	1
CAN-TMD1535W-K	Double 35 qt - White cans	15"	21-3/4"	18"	15"	18" base	100 lb	1
CAN-TMS1535B-K	Single 35 qt - Black can	15"	21-5/8"	18"	15"	18" base	100 lb	1
CAN-TMS1535G-K	Single 35 qt - Grey can	15"	21-5/8"	18"	15"	18" base	100 lb	1
CAN-TMS1535W-K	Single 35 qt - White can	15"	21-5/8"	18"	15"	18" base	100 lb	1
CAN-TMS1550B-K	Single 50 qt - Black can	15"	21-5/8"	22-1/4"	15"	18" base	100 lb	1
CAN-TMS1550G-K	Single 50 qt - Grey can	15"	21-5/8"	22-1/4"	15"	18" base	100 lb	1
CAN-TMS1550W-K	Single 50 qt - White can	15"	21-5/8"	22-1/4"	15"	18" base	100 lb	1
CAN-TMD1835B-K	Double 35 qt - Black cans	18"	21-5/8"	18"	18"	21" base	100 lb	1
CAN-TMD1835G-K	Double 35 qt - Grey cans	18"	21-5/8"	18"	18"	21" base	100 lb	1
CAN-TMD1835W-K	Double 35 qt - White cans	18"	21-5/8"	18"	18"	21" base	100 lb	1
CAN-TMD1850B-K	Double 50 qt - Black cans	18"	21-5/8"	22-1/4"	18"	21" base	100 lb	1
CAN-TMD1850G-K	Double 50 qt - Grey cans	18"	21-5/8"	22-1/4"	18"	21" base	100 lb	1
CAN-TMD1850W-K	Double 50 qt - White cans	18"	21-5/8"	22-1/4"	18"	21" base	100 lb	1
CAN-TMD2135B-K	Double 35 qt - Black cans	21"	21-5/8"	18"	21"	24" base	100 lb	1
CAN-TMD2135G-K	Double 35 qt - Grey cans	21"	21-5/8"	18"	21"	24" base	100 lb	1
CAN-TMD2135W-K	Double 35 qt - White cans	21"	21-5/8"	18"	21"	24" base	100 lb	1
CAN-TMD2150B-K	Double 50 qt - Black cans	21"	21-5/8"	22-1/4"	21"	24" base	100 lb	1
CAN-TMD2150G-K	Double 50 qt - Grey cans	21"	21-5/8"	22-1/4"	21"	24" base	100 lb	1
CAN-TMD2150W-K	Double 50 qt - White cans	21"	21-5/8"	22-1/4"	21"	24" base	100 lb	1

Recommended screw:

#8 flat head

Waste Container Organization: Wire Bottom Mount



Cans Sold Separately
See page 353

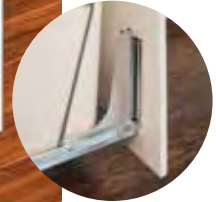

! Use optional door mounting kit for door pullout application

- Heavy duty 100 lb full extension ball bearing slides
- Thick wire frame construction
- Durable polymer trash cans are easily cleaned
- Cans and lids sold separately (see page 353)
- Quickly mounts to cabinet floor using four screws (included)

- Wire handle included
- Optional 6-way adjustable door mounting kit for door pullout application
- Retail packed with English, French and Spanish translations

Note: Double 50 qt can unit requires full height cabinet



	Description	Finish	Width	Depth	Height	Min. Opening	Standard Cabinet Size	Weight Capacity	Ctn Qty
CAN-EBMSB-R	Single Can Unit - 35 or 50 qt	Black	10-1/4"	22-1/16"	13"	11-1/2"	15" base	50 lb	6
CAN-EBMSPC-R	Single Can Unit - 35 or 50 qt	Polished Chrome	10-1/4"	22-1/16"	13"	11-1/2"	15" base	50 lb	6
CAN-EBMSW-R	Single Can Unit - 35 or 50 qt	White	10-1/4"	22-1/16"	13"	11-1/2"	15" base	50 lb	6
CAN-EBMDB-R	Double Can Unit - 35 qt only	Black	13-15/16"	22"	13"	14-1/2"	18" base	50 lb	4
CAN-EBMDPC-R	Double Can Unit - 35 qt only	Polished Chrome	13-15/16"	22"	13"	14-1/2"	18" base	50 lb	4
CAN-EBMDW-R	Double Can Unit - 35 qt only	White	13-15/16"	22"	13"	14-1/2"	18" base	50 lb	4
CAN-EBMD50B-R	Double Can Unit - 50 qt only	Black	15-3/16"	22-1/16"	12-13/16"	15-3/16"	18" base	50 lb	4
CAN-EBMD50PC-R	Double Can Unit - 50 qt only	Polished Chrome	15-3/16"	22-1/16"	12-13/16"	15-3/16"	18" base	50 lb	4
CAN-EBMD50W-R	Double Can Unit - 50 qt only	White	15-3/16"	22-1/16"	12-13/16"	15-3/16"	18" base	50 lb	4
CAN-DOORKIT	Door Mounting Kit	Black	2-1/2"	5-1/4"	6-5/8"	-	-	-	20
CAN-DOORKITPC	Door Mounting Kit	Polished Chrome	2-1/2"	5-1/4"	6-5/8"	-	-	-	20
CAN-DOORKITW	Door Mounting Kit	White	2-1/2"	5-1/4"	6-5/8"	-	-	-	20

Waste Container Organization: Cans & Lids



35 qt bins

50 qt bins

Cans available in 2 sizes and 3 standard colors – black, grey & white

Lids available in 3 standard colors plus green for recycling

High quality polymer material is durable and easy to clean

Compatible with all of our trash can pullouts

	Description	Can Color	Width	Depth	Height	Ctn Qty
CAN-35	35 qt Polymer Can	Black	14-1/4"	9-7/16"	18"	10
CAN-35W	35 qt Polymer Can	White	14-1/4"	9-7/16"	18"	10
CAN-35GRY	35 qt Polymer Can	Grey	14-1/4"	9-7/16"	18"	10
CAN-35LID	Lid for 35 qt Polymer Can	Black	14-1/4"	9-3/8"	1-5/8"	10
CAN-35LIDW	Lid for 35 qt Polymer Can	White	14-1/4"	9-3/8"	1-5/8"	10
CAN-35LIDGRY	Lid for 35 qt Polymer Can	Grey	14-1/4"	9-3/8"	1-5/8"	10
CAN-35LIDG	Lid for 35 qt Polymer Can	Green	14-1/4"	9-3/8"	1-5/8"	10
CAN-50	50 qt Polymer Can	Black	14-7/8"	10-1/4"	22-1/4"	10
CAN-50W	50 qt Polymer Can	White	14-7/8"	10-1/4"	22-1/4"	10
CAN-50GRY	50 qt Polymer Can	Grey	14-7/8"	10-1/4"	22-1/4"	10
CAN-50LID	Lid for 50 qt Polymer Can	Black	14-5/8"	10-1/4"	1-5/8"	10
CAN-50LIDW	Lid for 50 qt Polymer Can	White	14-5/8"	10-1/4"	1-5/8"	10
CAN-50LIDGRY	Lid for 50 qt Polymer Can	Grey	14-5/8"	10-1/4"	1-5/8"	10
CAN-50LIDG	Lid for 50 qt Polymer Can	Green	14-5/8"	10-1/4"	1-5/8"	10

Great for



Recycling



BASE CABINET ORGANIZATION



Knife Block Pullout
Page 359

Base Cabinet Organization

Maximize cabinet storage with Hardware Resources' base cabinet organization. From cabinet pullouts to mixer lifts, we can help you create a beautiful and organized kitchen.

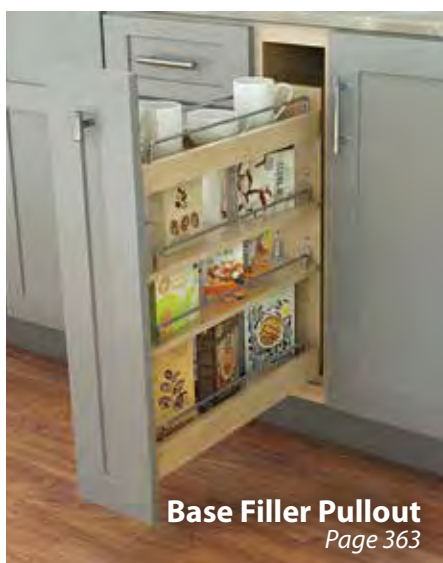

Some things should wiggle.

Your Cabinet Pullout Shouldn't.

Hardware Resources has designed the **sturdiest cabinet pullout on the market**

- "No Wiggle" patented hardware **eliminates excessive sag and side-to-side movement**
- **Ships fully assembled** and installs in minutes, saving time
- 6-way integrated door mounting hardware for **precise door adjustments**



Scan the QR code
with your smartphone
or mobile device or visit
<http://www.delivr.com/2h4vw>

Base Cabinet Organization: "No Wiggle" Base Pullout



Patented* top mounting bracket eliminates excessive side-to-side movement and sag, yet is hidden under the first shelf for a clean look

Bottom slides are concealed undermount slides, and the top is a 225 lb slide for added support and weight bearing (pre-installed)

Patented* integrated 6-way adjustable door-mounting brackets allow for easy mounting of door

Frameless Friendly! Works in both face frame and frameless applications

Ships fully assembled making installation a breeze

U.S. PATENTED

9,661,924 & 9,723,922
10,028,581 & 10,251,480

! Requires full door cabinet

Scan to watch the installation video
<http://delivr.com/22TZY>

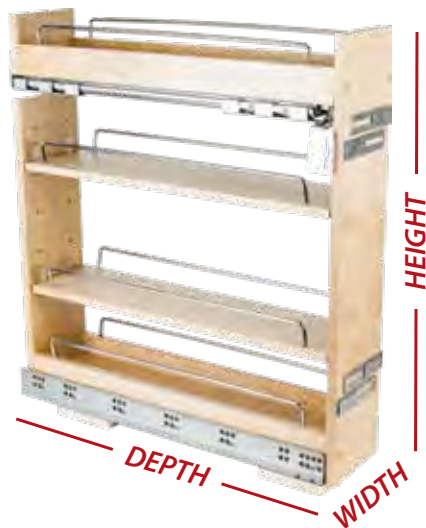

	Width	Depth	Height	Min. Opening	Standard Cabinet Size	Weight Capacity	Ctn Qty
BPO2-5SC	5-1/2"	22"	24"	5-1/2"	9" base	100 lb	1
BPO2-8SC	8-1/2"	22"	24"	8-1/2"	12" base	100 lb	1
BPO2-11SC	11-1/2"	22"	24"	11-1/2"	15" base	100 lb	1
BPO2-14SC	14-1/2"	22"	24"	14-1/2"	18" base	100 lb	1

Recommended screw: #8 flat head



Extra Rails		Ctn Qty
RAIL-17-PC	Extra rail for BPO series	50

Base Cabinet Organization: "No Wiggle" Pullouts

What makes a great pullout?

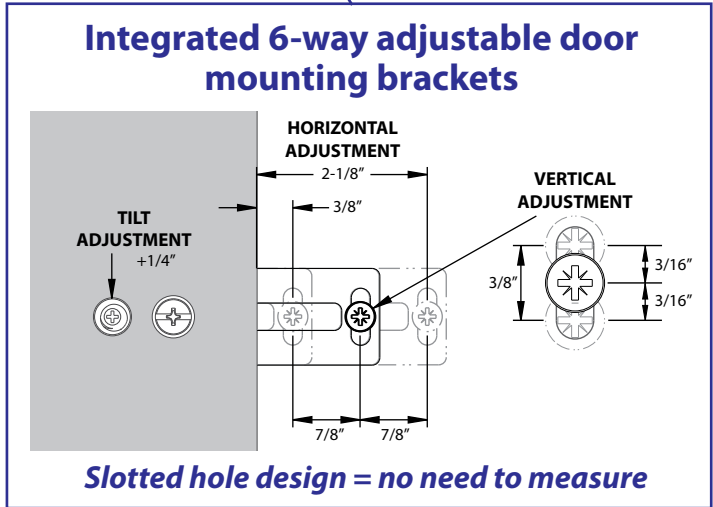
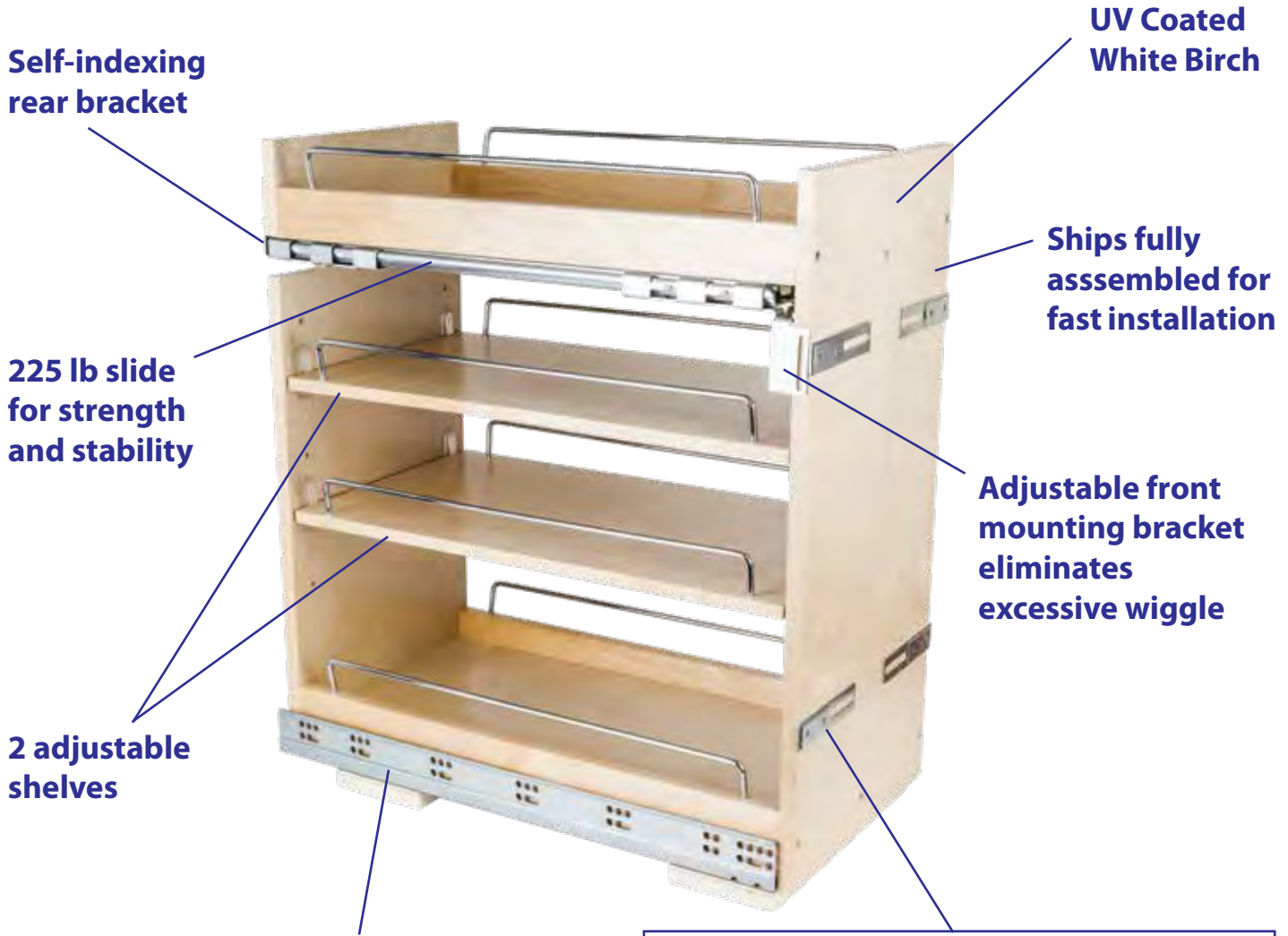

Patented mounting hardware
US Patents 9,661,924 & 10,028,581

NEW

Base Cabinet Organization: "No Wiggle" Knife Block Pullout

**Cabinet
Organizers**

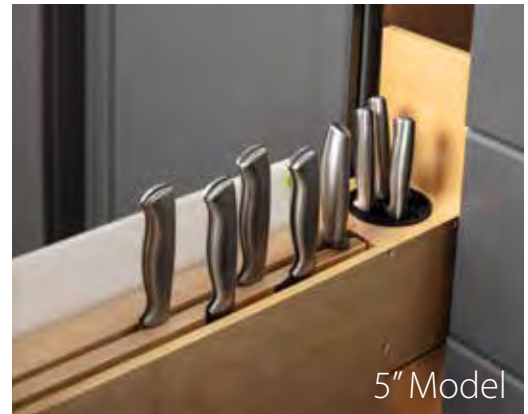

5" Model

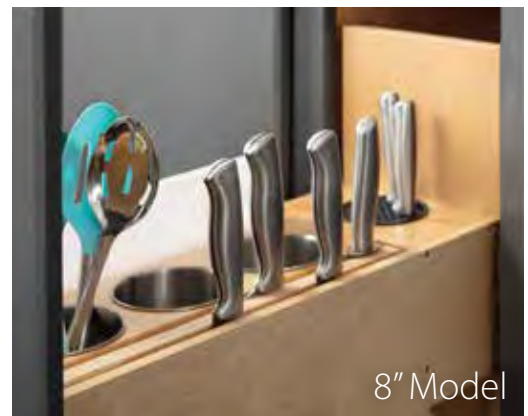

8" Model

Did you know...

- Storing knives in traditional knife blocks or plastic sheaths dulls their blades over time.
- Magnetic strips keep knives sharper by minimizing blade contact. Our new Knife Pullout features a strong magnetic bar embedded in wood for ideal knife storage.
- Sharp knives are key to safe and effective cutting, and good knives are expensive. Our innovative pullout protects this investment by storing knives properly.



Plastic Cutting Board

- Included with both models
- Stows neatly in custom slot
- Dishwasher safe
- Non-skid feet



Stainless Steel Utensil Bins

8" model also includes 3 bins that are easy to remove for cleaning (UCSS-46, Ctn Qty 50)

Double-sided magnetic bar with a total of 31.5" of knife storage (fits blades up to 9" long)

Round insert holds a set of six steak knives

Open bottom shelf provides additional storage

Patented* front mounting bracket eliminates excessive side-to-side movement and sag, yet is hidden for a clean look

Bottom slides are concealed undermount slides, and the top is a 225 lb slide for added support and weight bearing (pre-installed)

	Width	Depth	Height	Minimum Opening	Standard Cabinet Size	Weight Capacity	Ctn Qty
KBPO-5SC	5"	22"	24"	5-1/2"	9" base	100 lb	1
KBPO-8SC	8"	22"	24"	8-1/2"	12" base	100 lb	1

Recommended screw: screws included

Base Cabinet Organization: "No Wiggle" Utensil Pullout



- Convenient storage of kitchen utensils
- Included 4 stainless steel bins are sturdy and easy to remove for cleaning
- Open bottom shelf for additional storage
- Built on our "No Wiggle" platform
- Patented* top mounting bracket eliminates excessive side-to-side movement and sag, yet is hidden under the first shelf for a clean look
- Bottom slides are concealed undermount slides, and the top is a 225 lb slide for added support and weight bearing (pre-installed)
- Patented* integrated 6-way adjustable door-mounting brackets allow for easy mounting of door
- Frameless Friendly! Works in both face frame and frameless applications
- Ships fully assembled making installation a breeze



9,661,924 & 9,723,922
10,028,581 & 10,251,480

! Requires full door cabinet



	Width	Depth	Height	Min. Opening	Standard Cabinet Size	Weight Capacity	Ctn Qty
UBPO-5SC NEW	5-1/2"	22"	24"	5-1/2"	9" base	100 lb	1
UBPO-8SC	8-1/2"	22"	24"	8-1/2"	12" base	100 lb	1

Recommended screw:

Screws included



Replacement Utensil Bins Ctn Qty

UCSS-46	Replacemet bins for UBPO series	50
---------	---------------------------------	----

Base Cabinet Organization: "No Wiggle" Drawer Base Pullout



Fits below a drawer!

- Shorter height fits below drawer
- Built on our "No Wiggle" platform
- Patented* top mounting bracket eliminates excessive side-to-side movement and sag, yet is hidden under the first shelf for a clean look
- Bottom slides are concealed undermount slides, and the top is a 225 lb slide for added support and weight bearing (pre-installed)
- Patented* integrated 6-way adjustable door-mounting brackets allow for easy mounting of door
- One adjustable shelf included
- Frameless Friendly! Works in both face frame and frameless applications
- Ships fully assembled making installation a breeze



9,661,924 & 9,723,922
10,028,581 & 10,251,480



	Width	Depth	Height	Min. Opening	Standard Cabinet Size	Weight Capacity	Ctn Qty
DBPO-5SC	5-1/2"	22"	20"	5-1/2"	9" base	100 lb	1
DBPO-8SC	8-1/2"	22"	20"	8-1/2"	12" base	100 lb	1

Recommended screw: *Screws included*



Extra Rails

	Ctn Qty
RAIL-17-PC Extra rail for BPO series	50

Base Cabinet Organization: "No Wiggle" Tray Divider Pullout



Built on our "No Wiggle" platform
Patented* top mounting bracket eliminates excessive side-to-side movement and sag

Removable center rack and adjustable dividing bars allows for easy and versatile customization of storage needs

Patented* integrated 6-way adjustable door-mounting brackets allow for easy mounting of door

Frameless Friendly! Works in both face frame and frameless applications

Non-slip bottom mat keeps items secure and minimizes noise



9,661,924 & 9,723,922
10,028,581 & 10,251,480



Also great for foil, plastic wrap and bag storage



	Width	Depth	Height	Min. Opening	Standard Cabinet Size	Weight Capacity	Ctn Qty
BPOTD2-5SC	5"	22-1/4"	17-9/16"	5-1/2"	9" base	100 lb	1
BPOTD2-8SC	8"	22-1/4"	17-9/16"	8-1/2"	12" base	100 lb	1

Recommended screw:

#8 flat head

Base Cabinet Organization: "No Wiggle" Base Filler Pullout



- Used in 3" and 6" wide base cabinet applications
- Installs in dead space between base cabinets
- Built on our "No Wiggle" platform
- Patented* top mounting bracket eliminates excessive side-to-side movement and sag, yet is hidden under the first shelf for a clean look
- Patented* integrated 6-way adjustable door-mounting brackets allow for easy mounting of door
- Two adjustable shelves included
- Frameless Friendly! Works in both face frame and frameless applications
- Ships fully assembled making installation a breeze



9,661,924 & 9,723,922
10,028,581 & 10,251,480



	Width	Depth	Height	Min. Opening	Weight Capacity	Ctn Qty
BFPO2-3SC	3-1/2"	23"	30"	3-1/2"	100 lb	1
BFPO2-6SC	6-1/2"	23"	30"	6-1/2"	100 lb	1

Recommended screw: #6 face frame



Base Cabinet Organization: Peg Board Filler Pullout

This organizer takes the wasted space between cabinets and converts it into a customizable organized space. Organize everything from pots and pans to big utensils with the variety of included hooks.



Features our popular 303FUSFT Series Dura-Close™ full extension soft-close 100 lb ball bearing slides (pre-installed)

Each pullout comes with an assortment of pegs and hooks (12 pegs, 12 single hooks, 6 double hooks)

Additional hook packs are available for purchase (3 hooks/pack)

Available in 2 width options

Stainless steel pegboard is easy to clean and magnetic

Edgewise birch plywood construction with clear UV finish

! Can be mounted left- or right-handed



Extra Peg
BFPOSS-PEG



Extra Single Hook
BFPOSS-S3



Extra Double Hook
BFPOSS-D3



Chrome Rail
RAIL-17-PC

	Width	Depth	Height	Min. Opening	Weight Capacity	Ctn Qty
BFPOSS3	3"	23"	30"	3"	100 lb	1
BFPOSS6	6"	23"	30"	6"	100 lb	1

Recommended screw: #8 flat head

Extra Hardware

		Ctn Qty
BFPOSS-D3	Double hooks	3 hooks/bag
BFPOSS-S3	Single hooks	3 hooks/bag
BFPOSS-PEG	Single pegs	3 pegs/bag
RAIL-17-PC	Chrome rail	50 rails

Base Cabinet Organization: Appliance Lift



Scan to watch the installation video
<http://delivr.com/2NR58>

- Provides mechanical assistance for heavy appliances such as a mixer
- Features soft-close dampers for smooth closing
- Can be used in both frameless and face frame cabinetry
- Shelf (not included) can be custom fit to any cabinet size
- Three spring settings for up to 45 lb capacity



Pair with a wire pullout basket (MBPO series shown) to store appliance supplies and accessories

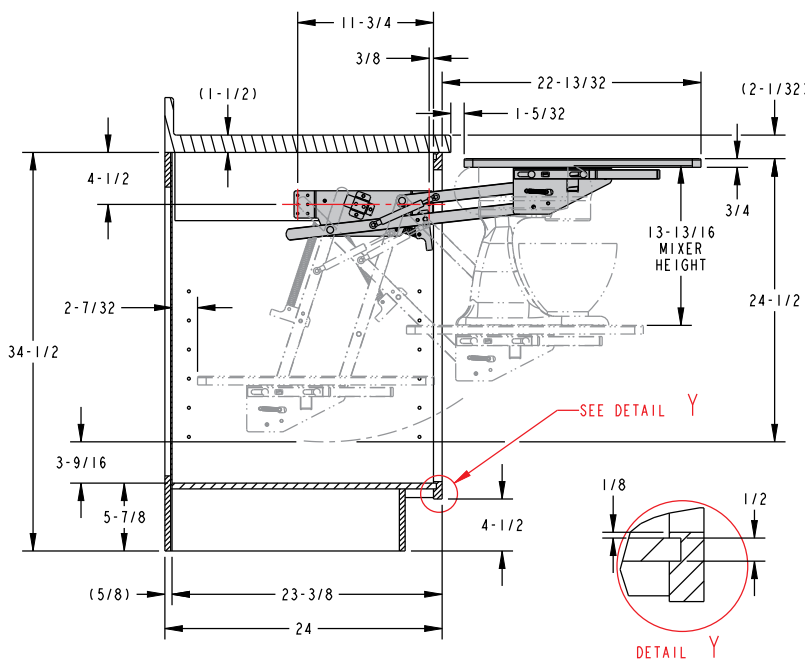

	Weight Capacity	Opening	Ctn Qty
ML-1CH	45 lb	12" min. 24" max.	1

Recommended screw: #8 pan head screws for mounting to cabinet included

Shelf material is not included. Shelf should be a minimum of 3/4" thick and no longer than 20-1/2" in length.

Shelf width is determined by measuring between the side mounting brackets minus 1-1/4". Mount shelf with at least 8 suggested #8 x 1/2" wood screws (not provided) to mounting brackets.

Base Cabinet Organization: Easy-to-Install Rollout Drawers



Skip the *measure...design...wait...* process

- Order rollout drawers that are **IN STOCK**
- Ships same day – Receive it in 2-3 days
- Ships fully assembled
- Easily and quickly installs with four screws (included)
- For existing cabinets or new construction
- Designed to fit standard cabinet sizes



	Width	Depth	Height	Bottom	Minimum Opening	Standard Cab. Size	Weight Capacity
RO12-WB	10-1/4"	21-1/4"	7"	1/4"	11-1/2"	15" base	100 lb
RO15-WB	13-1/4"	21-1/4"	7"	1/4"	14-1/2"	18" base	100 lb
RO18-WB	16-1/4"	21-1/4"	7"	1/4"	17-1/2"	21" base	100 lb
RO21-WB	19-1/4"	21-1/4"	7"	1/4"	20-1/2"	24" base	100 lb
RO24-WB	22-1/16"	21-1/4"	7"	1/2"	23-1/2"	27" base	100 lb
RO27-WB	25-1/16"	21-1/4"	7"	1/2"	26-1/2"	30" base	100 lb
RO33-WB	31-1/16"	21-1/4"	7"	1/2"	32-1/2"	36" base	100 lb
ROVHB12-WB	10-1/16"	18-7/16"	9"	1/4"	11-1/2"	15" vanity	100 lb
ROVHB15-WB	13-1/16"	18-7/16"	9"	1/4"	14-1/2"	18" vanity	100 lb
ROVHB18-WB	16-1/16"	18-7/16"	9"	1/4"	17-1/2"	21" vanity	100 lb



Beautiful White Birch dovetail boxes with UV coating
 Drawer boxes are built in our plant in the USA
 Featuring concealed undermount 3/4 extension soft-close slides

For your Bath

Reclaim the space in bathroom cabinets
 18" depth designed for bath cabinets
 Use multiple rollouts for wide cabinets

High-Back Drawers - 8" Back & 3" Front Drawer Height



For 12" opening
ROVHB12-WB



For 15" opening
ROVHB15-WB



For 18" opening
ROVHB18-WB



ROVHB15-WB & ROVHB12-WB shown in use

Base Cabinet Organization: Easy-to-Install Rollout Drawers

For your Kitchen

Rollout Drawers - 6" Drawer Height



For 12" opening
RO12-WB



For 15" opening
RO15-WB



For 18" opening
RO18-WB



For 21" opening
RO21-WB



For 24" opening
RO24-WB
1/2" bottom panel

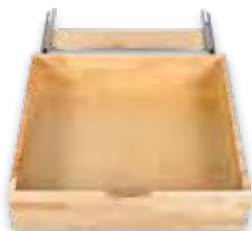

For 27" opening
RO27-WB
1/2" bottom panel



For 33" opening
RO33-WB
1/2" bottom panel



It's That Easy!



1 Measure

Measure the cabinet's interior width, depth and height. Hold your tape parallel to the cabinet's walls. Note any pipes, shelves, or hinges that may affect actual available space.



2 Set

Set your drawer base in place making sure you can open and close the cabinet door easily.



3 Secure

Using your Phillips screwdriver (or drill) and the screws provided, secure your organizer base. Place the drawer back on the base, and you're all done!

All you need:

Phillips Screwdriver

Cordless Drill



OR

Measuring Tape



Scan to watch the product video
<http://delivr.com/2uf4p>



Base Cabinet Organization: Build your Own Rollouts



Rollout Box

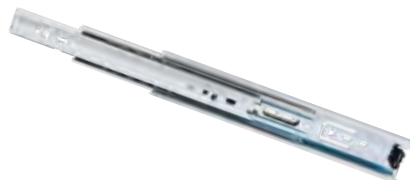

Drawer Slide

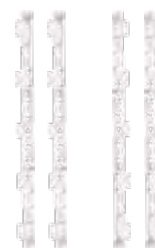

QuickTray Pilaster System



CUSTOMIZED STORAGE SOLUTIONS

Maximize your kitchen with custom storage solutions.

Our custom order-to-size rollouts are manufactured in our plant in Louisiana. Add our best-selling Dura-Close® drawer slides and our QuickTray pilaster system, and you can create custom storage solutions for your customers. Great for pantries, pot and lid storage, small kitchen appliances and miscellaneous kitchen wares. Customizable for any size cabinet, existing or new construction.



Pots & Lids



Pantry



Base Cabinet Organization: Quick Tray Pilaster System



- » System only requires four simple components
- » Overall height is 20-1/8"
- » Vertical adjustment of shelves in increments of 1-1/4"
- » No tools necessary for shelf adjustments
- » Front spacing lip allows for offset behind the face frame
- » Supports are non-handed for easy installation
- » Frameless application can be mounted with wood or euro screws
- » Face frame application can be fastened with staples or wood screws
- » Can be factory installed or added to existing cabinets

Pilasters:

Maple	B512-01	1-1/4" Pilaster System Pack, clear-coated maple pilaster with beige insert
	5 pc/ctn	Pack Includes: 4 pilasters, 8 hook dowels and 16 screws
White	B500-00	Quick Tray 1" Pilaster bulk pack
	100 pc/ctn	Pack Includes: 100 pilasters, 200 hook dowels and 200 screws
White	B520-00	1" Pilaster System Pack
	20 pks/ctn	Pack Includes: 4 pilasters, 8 hook dowels and 8 screws
Beige	B521-00	1-1/4" Pilaster System Pack
	20 pks/ctn	Pack Includes: 4 pilasters, 8 hook dowels and 8 screws
Beige	B520-01	1" Pilaster System Pack
	20 pks/ctn	Pack Includes: 4 pilasters, 8 hook dowels and 8 screws
Beige	B521-01	1-1/4" Pilaster System Pack
	20 pks/ctn	Pack Includes: 4 pilasters, 8 hook dowels and 8 screws

Use with any slide:

UNDERMOUNT







BALL BEARING

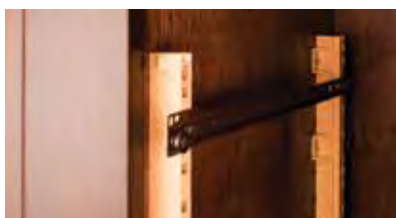

EPOXY



Accessories:

White	530117	7/8" Plastic Spacer with 1-3/8" CC holes	
	2000 pc/ctn	1-7/8" overall width	
Beige	EXE001	3/4" Spacer with 32 mm holes	
	100 pc/pk 10 pks/ctn	*Recommended screw: 6X7160-B	
Zinc	T-506	Hook Dowels for ball bearing slides	
	1000 pc/ctn	(sold individually)	
Zinc	T-508	Hook Dowels for undermount slides	
	1000 pc/ctn	(sold individually)	



Base Cabinet Organization: Custom Rollout Accessories

Slide Mounting Kit for Ball Bearing Slides



Custom dovetail drawer boxes,
303FU drawer slide and SLIDE-KIT shown in use



4 Zinc L-brackets & slide
attachment screws

SLIDE-KIT
50 pks/ctn

Recommended screw: #6 pan head

Perfect for rollout drawers - allows you to
mount slides directly to cabinet floor or
fixed shelf

Will fit 301FU series and 303FU series ball
bearing slides as well as USE series
undermount slides

Threaded collars mean secure attachment using
only a screwdriver

Screws for mounting to slides included

#6 pan head screw suggested for installation to cabinet floor



Base Cabinet Organization: Custom Rollout Accessories

Cabinet
Organizers

Rear Mounting Bracket for Undermount Slides



Custom dovetail drawer boxes, Quick Tray Pilaster System, USE58-100 drawer slide and USE-RMB shown in use



1 pair brackets &
attachment screws

USE-RMB
250 pks/ctn

Recommended screw: *included*

Attach rear mounting block to the back of the shelf instead of notching and boring

For use with USE58-500, USE58-300 or USE58-50 undermount slides

Maximum apron thickness 16mm (5/8") for our USE58 series slides

One pair of our drawer clips are required per shelf

Installation screws are provided

Base & Wall Organization: Dovetail Drawer Boxes



Ordering specifications:

- Standard Drawer, Rollout, or High-Back Rollout Boxes
- Assembled or Unassembled
- Standard Heights with Custom Depth & Width
- 1/4" Standard or 1/2" Bottom
- Optional Universal Notch for Undermount Slides
- Optional Undermount Slide Clip factory installed

Easy Online Ordering & Instant Price Quoting

See website for details

Production and delivery:

- Competitive pricing
- Standard 7 Day Turnaround after order confirmation
- Quick-to-Ship production on qualifying states



- A** 5/8" Hard Maple UV Coated or Unfinished
- B** 5/8" Aspen UV Coated
- C** 5/8" White Birch, Imported, Finger Jointed..... UV Coated
- D** 1/2" Birch Plywood UV Coated or Unfinished
- E** 1/2" Birch Plywood Edgebanded UV Coated
- F** 5/8" Rustic White Birch, Imported, Finger Jointed.. UV Coated
- G** 5/8" Rubberwood, Imported, Finger Jointed UV Coated

HEIGHT OPTIONS	2"	2.5"	3"	3.5"	4"	5"	6"	7"	8"	9"	9.5"	10"	11"	12"
1/2" Birch Plywood	x	x	x	x	x	x	x	x	x	x	x	x	x	
1/2" Edgebanded Plywood		x	x		x	x	x	x	x	x			x	x
5/8" Hardwoods	x	x	x	x	x	x	x	x	x	x	x	x	x	x
High-Back (all species)							x	x	x	x	x	x	x	x

*All high-back drawers will have a 3" front and a scoop cutout on the front face. 6" minimum height.

SIZING	Min. Depth	Max Depth	Min. Width (without clips)	Min. Width (with 4 & 6-way clips)	Min. Width (with 2-way clips)	Max Width	Min. Height
Standard Drawer							
5/8" Material	7"	51"	6"	7-1/4"	6-1/4"	51"	2"
1/2" Material	7"	51"	6"	7"	6"	51"	2"
Rollout Drawer							
5/8" Material	7"	51"	6"	7-1/4"	6-1/4"	51"	2"
1/2" Material	7"	51"	6"	7"	6"	51"	2"
High-Back Rollout							
5/8" Material	12"	51"	5-1/2"	7-1/4"	6-1/4"	51"	6"
1/2" Material	12"	51"	5-1/2"	7"	6"	51"	6"

Drawer boxes are manufactured in the USA by Hardware Resources. Hard Maple and Aspen are North American hardwoods. White Birch, Rustic White Birch, and Rubberwood are imported A/B grade hardwood, laminated & finger jointed. Birch plywood is Carb Compliant 9-ply high density plywood with no internal voids. UV cured coating is 100% solid and contains no VOC. Each UV coated piece is double coated to ensure a lasting finish.

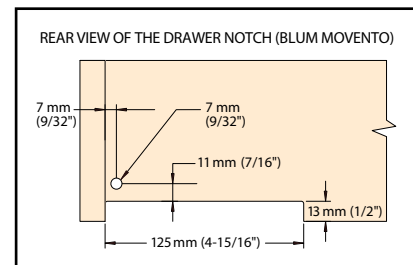
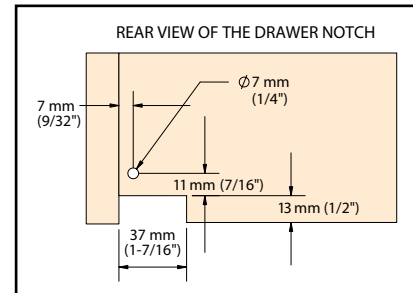



Base & Wall Organization: Dovetail Drawer Boxes



High-Back Rollout
(minimum 6" height)



Rollout

Complimentary High Definition Laser Engraving on Hardwood Boxes

- Upcharge per box for plywood only
- Simply provide a high-resolution file of your logo. We'll do the rest!
- Accepted file types are EPS, AI, PDF, PSD, JPEG, TIFF
- Maximum logo size is 1-1/2" tall x 6" long
- Minimum box height for engraving is 3"
- Not available on high-back rollouts or boxes over 24" deep
- Placed on the front left inside edge of the box
- One logo per customer. Logos are kept on file for future orders
- *Don't have a logo? Choose from our preselected fonts to customize your company name*



Drawer Box Linear Material



White Birch, Finger Jointed

	Height	Thickness	Coating	Ctn Qty
DW58X030	3"	5/8"	UV Coated	80LF
DW58X035	3-1/2"	5/8"	UV Coated	80LF
DW58X040	4"	5/8"	UV Coated	80LF
DW58X060	6"	5/8"	UV Coated	40LF
DW58X080	8"	5/8"	UV Coated	40LF
DW58X100	10"	5/8"	UV Coated	40LF

White Birch drawer box linear material is sold in 8' lengths in full carton quantity only



Aspen

	Height	Thickness	Coating	Ctn Qty
DA58X030	3"	5/8"	UV Coated	80LF
DA58X040	4"	5/8"	UV Coated	80LF
DA58X060	6"	5/8"	UV Coated	72LF
DA58X080	8"	5/8"	UV Coated	56LF
DA58X100	10"	5/8"	UV Coated	56LF

Aspen drawer box linear material is sold in random lengths of 5' - 8'

BATHROOM ORGANIZATION



Wire Basket Pullout
Page 383



"No Wiggle" Vanity Pullout
Pages 380-381

Bathroom Cabinet Organization

An organized bathroom is just as important as an organized kitchen. Getting ready for the day in an organized bathroom helps to eliminate stress and save time. These organizers help transform a bathroom from clutter to clarity.



Cleaning Caddy
Page 382



Wire Basket Pullout
Page 383

Not Just for the Kitchen

An organized bathroom is just as important as an organized kitchen. Getting ready for the day in an organized bathroom helps to eliminate stress and save time. These organizers help transform a bathroom from clutter to clarity.



1 DRAWER INSERTS

Our drawer inserts aren't just for the kitchen. Repurpose a cutlery organizer for makeup or personal grooming items or use a space drawer insert to keep nail polish organized.

See pages 418-425 for full product offering

2 TOWEL RACK

Add a designated spot to hold hand towels hidden away in the cabinet with a door mountable towel rack. Tiered design allows for free air movement to help dry damp towels.

See page 456 for more information

3 ROLLOUT DRAWERS

Add convenience of a drawer to any cabinet with our soft-close rollouts. Beautiful solid wood birch rollouts to match cabinet interiors. Can be added to cabinet bottom and/or shelf.

See pages 366-368 for full product offering



4 DOOR MOUNTED RACK

A door mounted rack in a bathroom vanity can keep bottles of beauty products and cans of spray tidy.
See pages 438-439 for more information

5 "NO WIGGLE" VANITY PULLOUT

Customize bathroom storage with a vanity pullout featuring premium soft-close undermount slides. The unit's shortened height and depth is designed to fit into bathroom vanity cabinets. A modular design allows for the addition of an optional grooming organizer or acrylic tray divider.
See pages 380-381 for more information



Get the Look

1 WIRE BASKET ROLLOUT

Wire basket rollouts are perfect for bath cabinets. Install to the cabinet bottom or a fixed shelf to bring items within easy reach.
See page 445 for more information

2 SPICE RACK

A door-mounted spice rack in a bath can keep bottles of beauty products and cans of spray tidy.
See pages 438-439 for more information



3 DRAWER INSERTS - CUTLERY

Cutlery drawer organizers can double as dividers for brushes, combs, toothbrushes, tubes of toothpaste, and more.
See pages 423-425 for more information

4 DRAWER INSERTS - SPICE TRAY

The spice tray insert's tiered racks keep bottles, brushes and tube from rolling around in the drawer.
See page 427 for more information

5 TRASH CAN PULLOUT

Every bathroom needs a trashcan, so tuck it out of sight with a trash can pullout.
See page 344 for full product offering

6 TOWEL RACK

An over-the-door towel rack is perfect for damp cloths and towels.
See page 453 for more information

7 CLEANING CADDY

Keep cleaning supplies or large bottles of beauty products easily accessible with the cleaning supply caddy.
See page 448 for more information

Bathroom Organization: "No Wiggle" Vanity Pullout

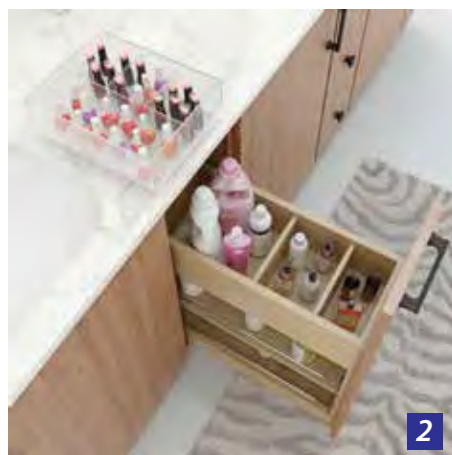

Tame Bath Clutter

Vanity base pullouts are great for narrow bathroom cabinets. Made of high quality wood and built on our superior "No Wiggle" platform, these pullouts are designed to keep clutter at bay. *See page 358 for more information*

- 1** The base pullout features fixed top and bottom shelves and one adjustable middle shelf. Middle and bottom shelves feature chrome rails to keep items secure. Optional top insert accessories maximize storage.
- 2** The acrylic tray insert is perfect for nail polish, makeup or other small items. And it's removable, so it can be set on the countertop for even easier access.
- 3** Use the Grooming Insert to store hair dryers, curling irons and other hair appliances.



- Shortened height and depth designed to fit into bathroom vanity cabinets
- Patented* hardware eliminates excess side-to-side movement
- Modular design allows for the use of optional grooming organizer or acrylic tray
- Smooth soft-close slides (pre-installed)
- Adjustable dividers and shelf
- Patented* 6-way adjustable door mounting brackets allows for easy mounting of doors

U.S. PATENTED

9,661,924 & 9,723,922
10,028,581 & 10,251,480

! Accessory inserts require full door cabinet



VBPO-G01



Use the pullout by itself or customize it with an accessory insert



VBPO-T01



VBPO8-SC

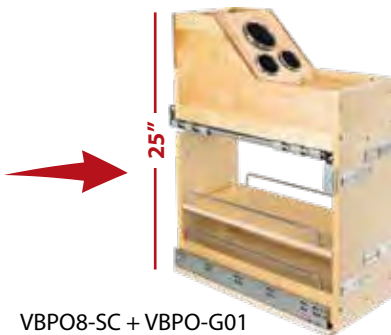

VBPO8-SC + VBPO-G01
*total assembled height = 25"



VBPO8-SC

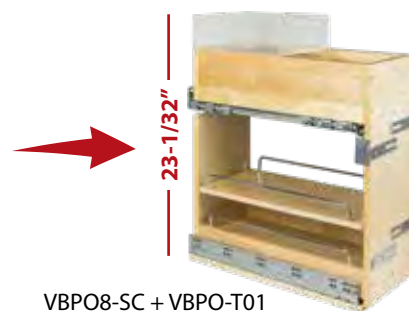

VBPO8-SC + VBPO-T01
*total assembled height = 23-1/32"

	Description	Width	Depth	Height*	Min. Opening	Standard Cabinet Size	Weight Capacity	Ctn Qty
VBPO8-SC	8" wide "No Wiggle" vanity pullout	8-1/2"	18-13/16"	19-7/8	8-1/2"	12" base	100 lb	1
VBPO-G01	Grooming organizer insert	8"	18-7/32"	9"	8-1/2"	12" base	-	1
VBPO-T01	Acrylic tray insert	8"	10-3/32"	3-7/16"	8-1/2"	12" base	-	1

Recommended screw:

Screws included

*Total assembled height of Vanity Base Pullout with inserts is listed above

Bathroom Organization: Powered Vanity

NEW





Convert a vanity drawer into a hair stylist workstation with our Powered Vanity Drawer. This dovetail drawer is equipped with a powered two plug receptacle. Hair appliances can stay plugged in and ready to go whenever you are. An automatic shut-off switch cuts power when the drawer is closed to ensure safe storage. Two stainless steel canisters hold appliances and an additional caddy on the top keeps all grooming items together. The drawer comes fully assembled with slides and power cord management hardware attached and ready for installation. Add glamour and convenience to every bathroom suite with this powered vanity organizer.

- Max AC Current: 15 amps @ 120 VAC
- Dual power receptacle
- Removable caddy tray
- Soft-close, synchronized, undermount slides
- Steel canister storage bins
- Automatic power shutoff when drawer is closed
- 8 ft power cord with NEMA 5-15 right angle plug
- Design to fit 15" wide vanity drawer opening

UL Recognized to UL962/CSA C22.2 No. 0:20 | Patent Pending



	Description	Width	Depth	Height*	Min. Opening	Standard Cabinet Size	Weight Capacity	Ctn Qty
PVGD15-SC	15" powered vanity drawer	15"	19-23/32"	8-23/32"	15"	18" vanity base	100 lb	1

Recommended screw: _____ **Screws included**

Bathroom Organization: Wire Cleaning Supply Caddy



- Ergonomic plastic handle
- Removable caddy keeps cleaning supplies organized
- Holds a variety of bottles and boxes
- Mounts easily under your sink, left- or right-handed
- Simply pick it up and take it with you
- Plastic liner tray catches drips
- Full extension ball bearing slides
- Heavy duty wire construction
- 25 lb capacity
- Quickly mounts to cabinet floor using four screws (included)



	Description	Finish	Width	Depth	Height	Min. Opening	Fits Standard Cabinet Size	Weight Capacity	Ctn Qty
SCPO2-R	Cleaning Caddy Pullout	Polished Chrome	11-5/8"	19-11/16"	15-15/16"	11-5/8"	15" – 18" base	25 lb	2

Bathroom Organization: Wire Basket Rollout

Cabinet
Organizers



- Great for organizing your cookware or pantry
- Full extension ball bearing slides
- Heavy duty wire construction
- Quickly mounts to cabinet floor or fixed shelf using four screws (included)



	<i>Description</i>	<i>Finish</i>	<i>Width</i>	<i>Depth</i>	<i>Height</i>	<i>Min. Opening</i>	<i>Fits Standard Cabinet Size</i>	<i>Weight Capacity</i>	<i>Ctn Qty</i>
MBPO15-R	Pullout Basket	Polished Chrome	11-3/8"	19-11/16"	6-3/16"	11-1/2"	15" base	50 lb	3
MBPO18-R	Pullout Basket	Polished Chrome	14-3/8"	19-11/16"	6-3/16"	14-1/2"	18" base	50 lb	3
MBPO21-R	Pullout Basket	Polished Chrome	17-3/8"	19-11/16"	6-3/16"	17-1/2"	21" – 24" base	50 lb	3

CORNER ORGANIZATION



Storage with Style® Blind Corner Pullout
Pages 330-331



Blind Corner Swingout
Pages 386-387



Blind Corner Sliding Door
Pages 388-389



Easy 360 Susan
Pages 390-391

Blind Corner Organization

With Hardware Resources' blind corner organizers, previously unused cabinet space is a thing of the past. Blind corner organizers bring forward items stored in the far back corner. Our Easy 360 Susan is a fresh and updated corner solution that is a hybrid of a lazy susan and pullout shelves.



Premium Wood Lazy Susan
Pages 394-395



Economy Plastic Lazy Susan
Page 403



Half-moon Lazy Susan
Page 405

Lazy Susan Corner Organization

Hardware Resources' line of lazy susan corner organizers include tried-and-true round and kidney options in plastic and wood.

Blind Corner Organization: Swingout



Scan to watch the installation video
<http://delivr.com/288f6>



BCSO215PCMP-LH
Maple non-slip shelf



BCSO215PCWD-LH
Walnut textured non-slip shelf



BCSO215BOWD-LH
Walnut textured non-slip shelf

Sold as a complete unit in left- or right-handed versions for full-height base cabinets

Metal edging finishes coordinate with popular decorative hardware finishes

Easy installation – no need to drill into the side walls, mounts directly to cabinet floor with optional top mounting for additional stability

Installation instructions and mounting hardware included



BCSO215PCWH-LH
White non-slip shelf



BCSO215GWH-LH
White smooth shelf

Do I need Left Hand or Right Hand?

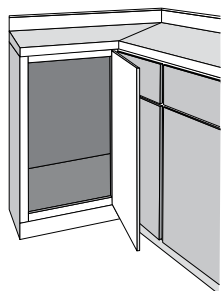

Left Hand blind corners have the opening on the **left**.

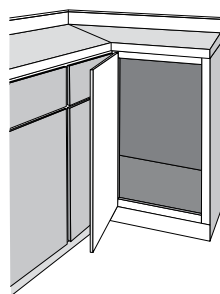

Right Hand blind corners have the opening on the **right**.

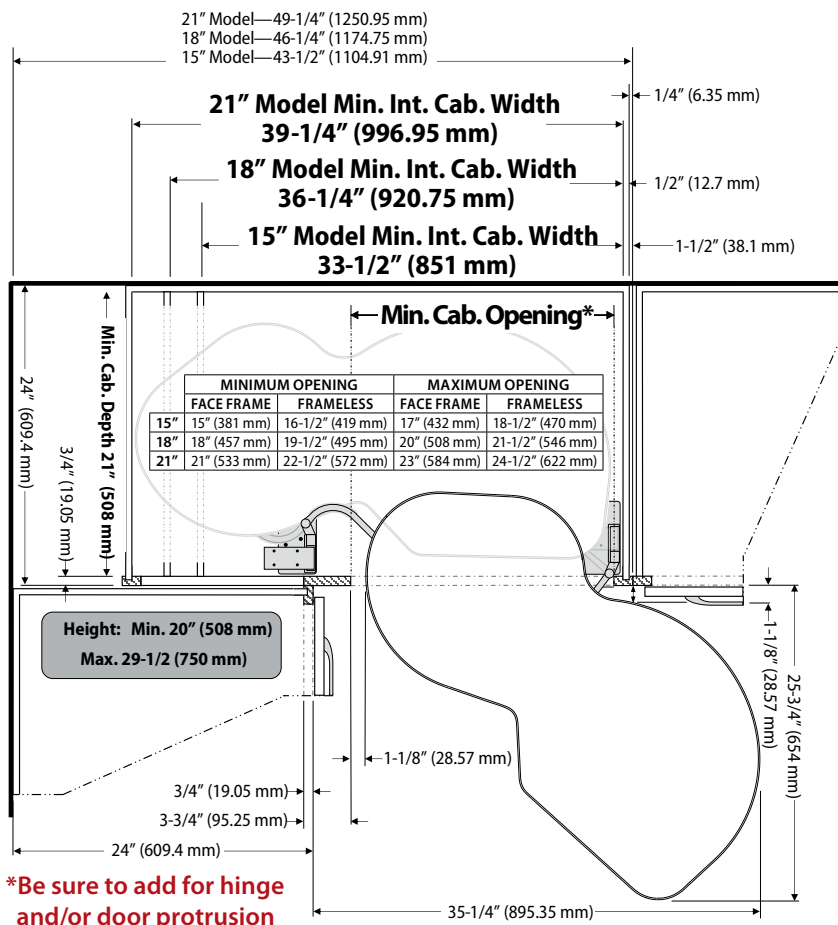

Left Handed	Right Handed	Frame Color	Shelf Bottom/Edging	Shelf Dimensions	Weight Capacity	Ctn Qty
PREMIUM OPTIONS - NON-SLIP COATED SHELVES, PLATED EDGING						
BCSO215BOWD-LH	BCSO215BOWD-RH	Oil Rubbed Bronze	Walnut/Oil Rubbed Bronze	31-1/2" x 14-1/4"	90 lb	1
BCSO215PCMP-LH	BCSO215PCMP-RH	Grey	Maple/Polished Chrome	31-1/2" x 14-1/4"	90 lb	1
BCSO215PCWD-LH	BCSO215PCWD-RH	Grey	Walnut/Polished Chrome	31-1/2" x 14-1/4"	90 lb	1
BCSO215PCWH-LH	BCSO215PCWH-RH	Grey	White/Polished Chrome	31-1/2" x 14-1/4"	90 lb	1
BCSO218BOWD-LH	BCSO218BOWD-RH	Oil Rubbed Bronze	Walnut/Oil Rubbed Bronze	32-13/16" x 16-3/4"	90 lb	1
BCSO218PCMP-LH	BCSO218PCMP-RH	Grey	Maple/Polished Chrome	32-13/16" x 16-3/4"	90 lb	1
BCSO218PCWD-LH	BCSO218PCWD-RH	Grey	Walnut/Polished Chrome	32-13/16" x 16-3/4"	90 lb	1
BCSO218PCWH-LH	BCSO218PCWH-RH	Grey	White/Polished Chrome	32-13/16" x 16-3/4"	90 lb	1
BCSO221BOWD-LH	BCSO221BOWD-RH	Oil Rubbed Bronze	Walnut/Oil Rubbed Bronze	37-7/16" x 18-3/8"	90 lb	1
BCSO221PCMP-LH	BCSO221PCMP-RH	Grey	Maple/Polished Chrome	37-7/16" x 18-3/8"	90 lb	1
BCSO221PCWD-LH	BCSO221PCWD-RH	Grey	Walnut/Polished Chrome	37-7/16" x 18-3/8"	90 lb	1
BCSO221PCWH-LH	BCSO221PCWH-RH	Grey	White/Polished Chrome	37-7/16" x 18-3/8"	90 lb	1
ECONOMY OPTIONS - SMOOTH FINISH SHELVES, POWDER COATED EDGING						
BCSO215GWH-LH	BCSO215GWH-RH	Grey	White/Grey	31-1/2" x 14-1/4"	90 lb	1
BCSO218GWH-LH	BCSO218GWH-RH	Grey	White/Grey	32-13/16" x 16-3/4"	90 lb	1
BCSO221GWH-LH	BCSO221GWH-RH	Grey	White/Grey	37-7/16" x 18-3/8"	90 lb	1

Blind Corner Organization: Sliding Door



- 4 heavy gauge chrome baskets
- 4 non-slip clear acrylic basket liners
- Heavy duty soft-close slides with 200 lb capacity
- Soft-close door damper
- Door mounting brackets with 6-way adjustment (in/out, up/down and left/right)
- Flexible mounting options: secure to side walls or top of cabinet with adjustable brackets
- Rear basket position is adjustable to accommodate different blind corner depths (from 30-7/8"-38")
- Universal design - mount it left- or right-handed
- For frameless cabinets - can be used in face frame with side wall blocking



Also great for dishes & small appliances



Mount it with or without door attached.



Scan to watch the
installation video

<http://delivr.com/22w9g>

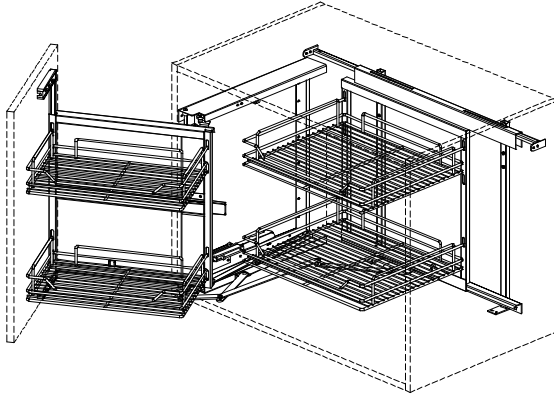

Large basket: 17-15/32" (456 mm) W x 15-1/2" (394 mm) D x 3-11/32" (85 mm) H

Small Basket: 17-5/32" (436 mm) W x 10-1/8" (257 mm) D x 3-11/32" (85 mm) H

	Width	Depth	Height	Cabinet Size	Weight Capacity	Ctn Qty
CS-SDCO	30-7/8– 38"	20-1/2"	21-5/8"	blind corner 15"–18" opening	200 lb	1

Recommended screw: #6 pan head

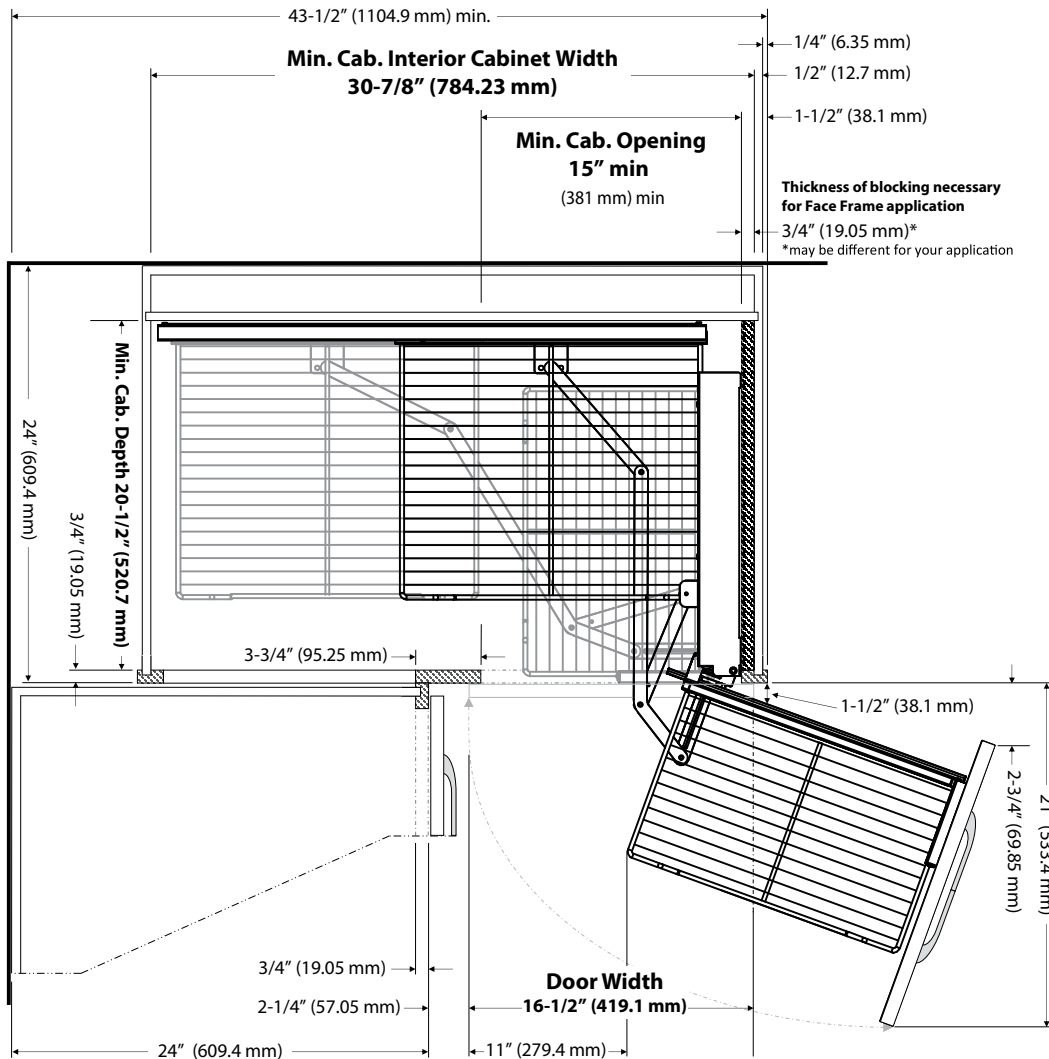

Corner Organization: Easy 360 Susan

Transform the corner cabinet from cumbersome to a versatile usable space by combining the convenience of a drawer with the benefits of a lazy susan.



Scan to watch the
installation video
<http://delivr.com/2vcyq>



- 6 heavy gauge chrome baskets
- 6 non-slip clear acrylic basket liners
- Full circle 360 degree rotation, left or right
- Sliding center baskets are accessible from either front or back
- Heavy duty 175 lb total capacity
- Adjustable height 24" to 30" inches
- Both shelves rotate together

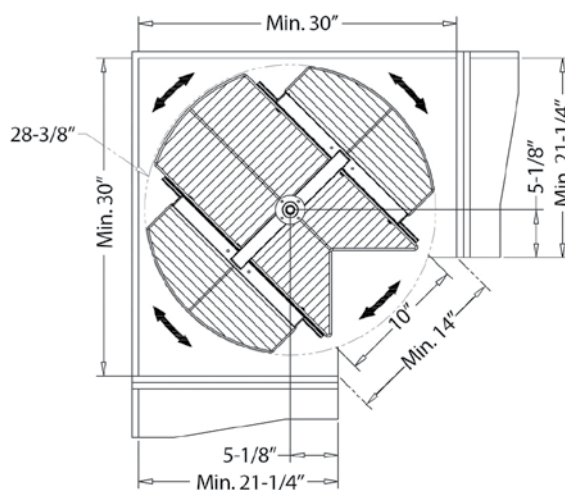

Cabinet requirements:
 Diameter - 30"
 Depth - 21-1/4"
 Pie Cut diagonal opening* - 14"

*Be sure to add for hinge and/or door protrusion

	Diameter	Height	Cabinet Size	Min. Opening	Weight Capacity	Ctn Qty
CS-ES360	28-3/8"	24-13/16"-30"	30" corner	28-3/8"	175 lb	1

Recommended screw: #6 pan head

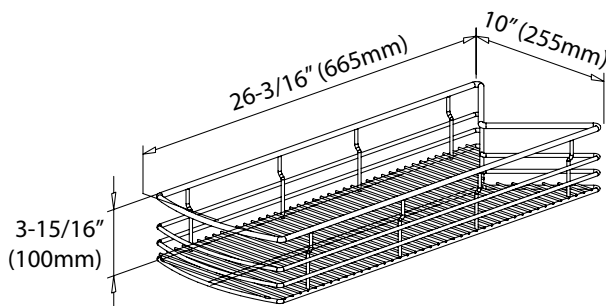
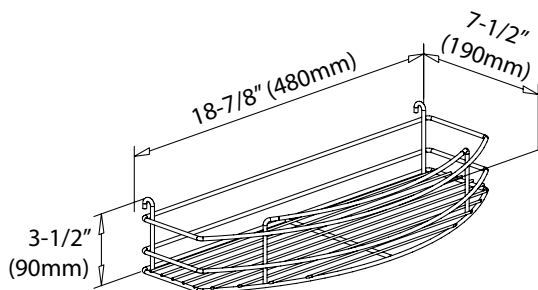



NEW Blind Corner Pullout

All four baskets pull out of the cabinet opening for full access

Metal baskets are adjustable in height

Universal design for left or right-hand blind corners

Available in standard and full-height blind corner cabinets.

For full-height option, additional baskets can be added to make a 3-tier organizer.

Includes heavy-duty soft-close slides for smooth movement in and out of the cabinet (preinstalled)

Heavy-duty frame construction ensures organizer is stable when in motion

Acrylic liners add stability to baskets and are easy to clean





Black Nickel



Polished Chrome

Description	Item Number	Frame Color	Width	Depth	Height	Standard Cabinet Size	Weight Capacity	Ctn Qty*
Blind Corner Organizer for Standard Height 15" Opening	SWS-BCS15BN	Black Nickel	26-13/16"	22-1/8"	20-9/16"	Blind Corner with drawer	130 lb	1
	SWS-BCS15PC	Polished Chrome	26-13/16"	22-1/8"	20-9/16"	Blind Corner with drawer	130 lb	1
Blind Corner Organizer for Standard Height 18" Opening	SWS-BCS18BN	Black Nickel	32-7/8"	22-1/8"	20-9/16"	Blind Corner with drawer	130 lb	1
	SWS-BCS18PC	Polished Chrome	32-7/8"	22-1/8"	20-9/16"	Blind Corner with drawer	130 lb	1
Blind Corner Organizer for Full Height 15" Opening	SWS-BCFH15BN†	Black Nickel	26-13/16"	22-1/8"	24-1/16"	Blind Corner - full height door	130 lb	1
	SWS-BCFH15PC†	Polished Chrome	26-13/16"	22-1/8"	24-1/16"	Blind Corner - full height door	130 lb	1
Blind Corner Organizer for Full Height 18" Opening	SWS-BCFH18BN†	Black Nickel	32-7/8"	22-1/8"	24-1/16"	Blind Corner - full height door	130 lb	1
	SWS-BCFH18PC†	Polished Chrome	32-7/8"	22-1/8"	24-1/16"	Blind Corner - full height door	130 lb	1
Pair of Extra Baskets for SWS-BCFH15 15" Opening	SWS-BCBAS15BN†	Black Nickel	12-3/16"	15-9/16"	3-9/16"	-	25 lb	1
	SWS-BCBAS15PC†	Polished Chrome	12-3/16"	15-9/16"	3-9/16"	-	25 lb	1
Pair of Extra Baskets for SWS-BCFH18 18" Opening	SWS-BCBAS18BN†	Black Nickel	15-3/16"	15-9/16"	3-9/16"	-	25 lb	1
	SWS-BCBAS18PC†	Polished Chrome	15-3/16"	15-9/16"	3-9/16"	-	25 lb	1

Recommended screw:

screws included

†Full height door required *Ships in two boxes

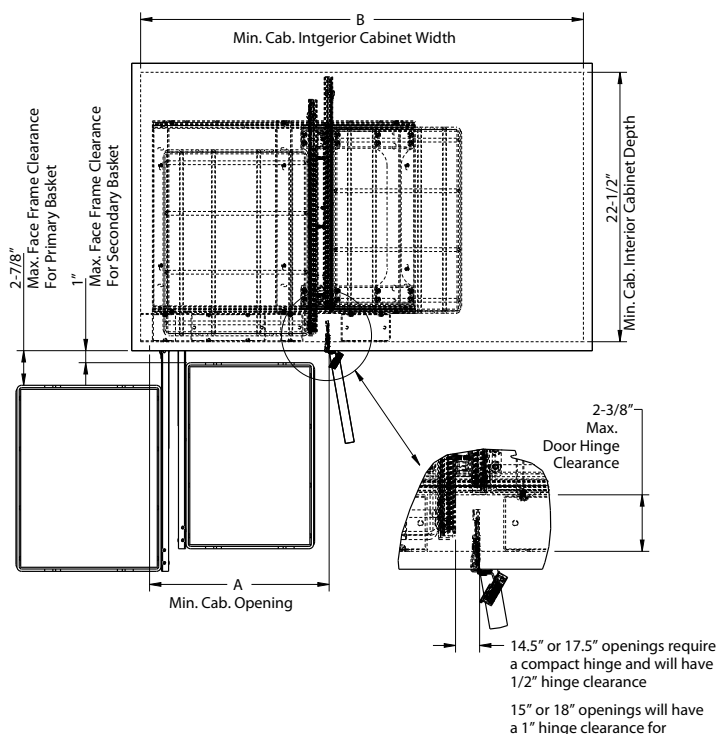

	Door Opening Height	A	B
SWS-BCS15BN	20-9/16"	14.5"	27"
SWS-BCS15PC	20-9/16"	14.5"	27"
SWS-BCS18BN	20-9/16"	17.5"	33"
SWS-BCS18PC	20-9/16"	17.5"	33"
SWS-BCFH15BN	24-1/16"	14.5"	27"
SWS-BCFH15PC	24-1/16"	14.5"	27"
SWS-BCFH18BN	24-1/16"	17.5"	33"
SWS-BCFH18PC	24-1/16"	17.5"	33"

Corner Organization: Premium Wood Lazy Susan Kits



Scan to watch the
installation video
<http://delivr.com/276SA>

Corner Organization: Premium Wood Lazy Susan Kits

- Lazy susan shelf is made from birch plywood with UV finish
- Solid birch finger jointed rim
- Shelves have a 1" inside rim height and 1-5/8" overall height
- Independently rotating shelves
- Positive stop on kidney shelf units
- Chrome-plated pole with stylish chrome hubs featuring adjustable height
- Sold as complete set with shelves, poles, mounting hardware and instructions included

**Twist and Lock Pole
for Easy Installation**



Round

	# Trays	Diameter	Interior Cabinet Height	Min. Opening	Ctn Qty
LSR218-SET	2	18"	21-1/2"-37-1/4"	18"	1
LSR224-SET	2	24"	21-1/2"-37-1/4"	24"	1
LSR228-SET	2	28"	21-1/2"-37-1/4"	28"	1
LSR2318-SET	3	18"	31-1/2"-43"	18"	1

Weight Capacity: 20 lb per square foot



Kidney

	# Trays	Diameter	Interior Cabinet Height	Min. Opening	Ctn Qty
LSK224-SET	2	24"	21-1/2"-37-1/4"	24"	1
LSK228-SET	2	28"	21-1/2"-37-1/4"	28"	1
LSK232-SET	2	32"	21-1/2"-37-1/4"	32"	1

Weight Capacity: 20 lb per square foot



Corner Organization: Premium Wood Shelves & Poles



*Poles & Shelves
Sold Separately*

Corner Organization: Premium Wood Shelves & Poles



Constructed with strong 5/8" thick birch plywood base and 1" inside height solid birch finger jointed rim

Clear UV finish

Available with and without 1-1/2" center hole for shelf or pole installation

Shelves	Diameter	Height	Min. Opening	Ctn Qty
LSK24*	24"	1-5/8"	24"	4
LSK28*	28"	1-5/8"	28"	4
LSK32*	32"	1-5/8"	32"	4
LSK24H**	24" with hole	1-5/8"	24"	4
LSK28H**	28" with hole	1-5/8"	28"	4
LSK32H**	32" with hole	1-5/8"	32"	4

Recommended screw: #6 pan head

*Weight Capacity: 20 lb per square foot
** Weight Capacity: 30 lb



Heavy duty steel pole system for 2 kidney shelves, measures 16-1/2" in overall height with shelves installed

Kidney with 1-1/2" hole installs to bottom shelf, kidney without hole installs to top shelf – both shelves feature positive stop to self-align with pie corner

Powdercoated almond finish blends with wooden trays and matches most applications

Poles	Height	Ctn Qty
LSP2 (2 shelves)	16-1/2"	4

Recommended screw: #8 pan head

Corner Organization: Premium Wood Swivel Lazy Susans

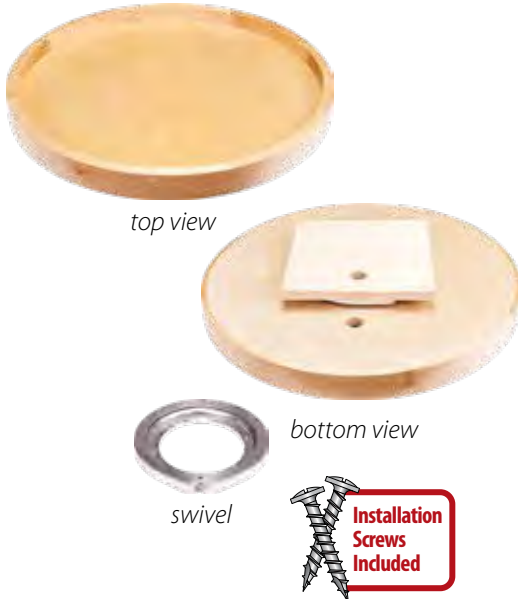

Lazy susan made from strong 5/8" birch plywood base with 1" inside height solid birch finger jointed rim, all with a clear UV finish

Preinstalled with a high quality cast aluminum swivel with solid steel bearings

Swivel is non-stop for continuous smooth revolutions

Easy to install, minimal installation time, 4 screws included

Matching color plastic cap included to cover installation hole in lazy susan

Round	Diameter	Shelf Height	Swivel Size	Min. Opening	Ctn Qty
LSR18-S	18"	1-5/8"	7"	18"	4
LSR24-S	24"	1-5/8"	7"	24"	4
LSR28-S	28"	1-5/8"	10"	28"	4

Weight Capacity: 20 lb per square foot

Lazy susan made from strong 5/8" birch plywood base with 1" inside height solid birch finger jointed rim, all with a clear UV finish

Preinstalled with a high quality cast aluminum swivel with solid steel bearings

360° swivel with stop

Easy to install, minimal installation time, 4 screws included

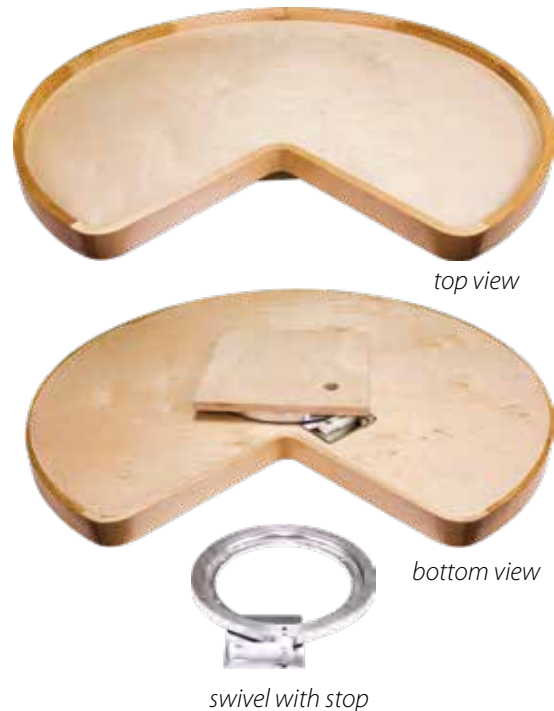

Kidney	Diameter	Shelf Height	Swivel Size	Min. Opening	Ctn Qty
LSK28-S	28"	1-5/8"	10" with stop	28"	4
LSK32-S	32"	1-5/8"	10" with stop	32"	4

Weight Capacity: 20 lb per square foot

Scan to watch the installation video
<http://delivr.com/2GNPF>



Corner Organization: Economy Wire Swivel Lazy Susans

Cabinet
Organizers

360°
rotating

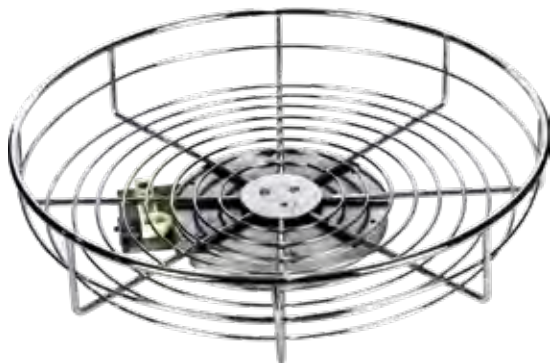

- 360 degree revolving tray
- Great for organizing dry goods and cans
- Fits 24" diagonal wall corner cabinet
- Heavy duty wire construction
- Quickly mounts to cabinet floor or fixed shelf using four screws (included)



	Description	Finish	Diameter	Height	Min. Opening	Fits Standard Cabinet Size	Weight Capacity	Ctn Qty
MLSR18-S-R	Single Shelf Lazy Susan	Polished Chrome	17-5/16"	3-13/16"	18"	24" diagonal wall corner	30 lb	1

Corner Organization: Economy Banded Swivel Lazy Susans

Lazy susan made from birch plywood with clear UV finish
 1" inside rim height and 1-9/16" overall height
 Preinstalled with a steel swivel
 Swivel is nonstop for continuous smooth revolutions
 Easy to install, minimal installation time,
 4 screws included
 Matching color plastic cap included to
 cover installation hole in lazy susan



top view



bottom view

Round

	Diameter	Swivel Size	Min. Opening	Ctn Qty
BLSR18-S	18"	8"	18"	4
BLSR20-S	20"	8"	20"	4
BLSR24-S	24"	8"	24"	4
BLSR28-S	28"	9"	28"	4

Weight Capacity: 20 lb per square foot

Lazy susan made from birch plywood with clear UV finish
 1" inside rim height and 1-9/16" overall height
 Preinstalled with a steel swivel
 360° swivel with stop
 Easy to install, minimal installation time, 4 screws included



top view



bottom view

Kidney

	Diameter	Swivel Size	Min. Opening	Ctn Qty
BLSK28-S	28"	8" with stop	28"	4
BLSK32-S	32"	9" with stop	32"	4

Weight Capacity: 20 lb per square foot



Scan to watch the
 installation video

<http://delivr.com/2M9W7>



Corner Organization: Economy Banded Lazy Susan Kits

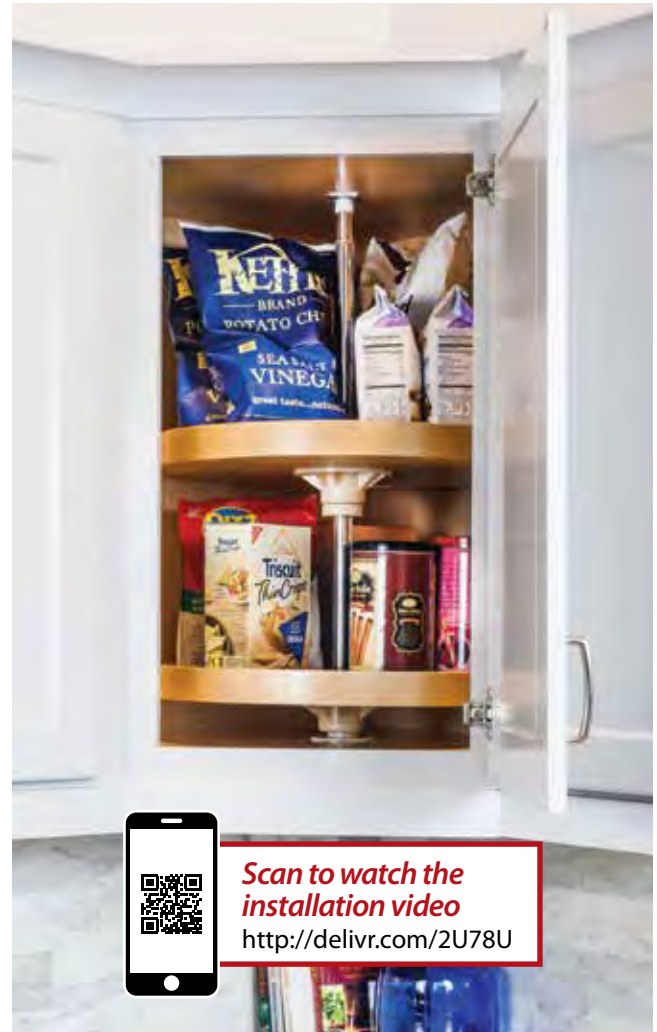

Scan to watch the
installation video
<http://delivr.com/2U78U>

Round	# Trays	Diameter	Interior Cabinet Height	Min. Opening	Ctn Qty
BLSR218-SET	2	18"	24-1/2"-32-3/4"	18"	1
BLSR220-SET	2	20"	24-1/2"-32-3/4"	20"	1
BLSR224-SET	2	24"	24-1/2"-32-3/4"	24"	1
BLSR228-SET	2	28"	24-1/2"-32-3/4"	28"	1
BLSR2318-SET	3	18"	37-3/8"-46"	18"	1
BLSR2320-SET	3	20"	37-3/8"-46"	20"	1

Weight Capacity: 20 lb per square foot

Kidney	# Trays	Diameter	Interior Cabinet Height	Min. Opening	Ctn Qty
BLSK224-SET	2	24"	24-1/2"-32-3/4"	24"	1
BLSK228-SET	2	28"	24-1/2"-32-3/4"	28"	1
BLSK232-SET	2	32"	24-1/2"-32-3/4"	32"	1

Weight Capacity: 20 lb per square foot

- Shelf is made from birch plywood with clear UV finish
- Shelves have a 1" inside rim height and 1-9/16" overall height
- Independently rotating shelves
- Chrome pole with beige polymer bearings that blend with wooden shelves
- Pole features adjustable shelves
- Positive stop on kidney shelf units
- Height adjustable for cabinets with 25-3/4" - 32-3/4" interior heights (37-3/8" - 46" for 3 tier)
- Sold as complete set with shelves, poles, mounting hardware and instructions included

Corner Organization: Plastic Lazy Susan with Chrome Hub Kits



Independently rotating shelves featuring smooth surface area

Chrome-plated stainless steel pole with chrome-plated hubs and adjustable height

Pole features adjustable shelves

Positive stop on kidney shelf units

18" diameter shelves have 1-7/16" overall rim height and 9/16" inside rim height

24" and 28" diameter shelves have 1-7/8" overall rim height and 1" inside rim height

32" diameter shelves have 2-1/8" overall rim height and 1-3/8" inside rim height

Sold as complete set with shelves, poles, mounting hardware and instructions included



Scan to watch the installation video
<http://delivr.com/2D4U3>



Round	# Trays	Diameter	Interior Cabinet Height	Min. Opening	Ctn Qty
PLSMR18	2	18"	21-1/2"-37-1/4"	18"	1
PLSMR24	2	24"	21-1/2"-37-1/4"	24"	1
PLSMR28	2	28"	21-1/2"-37-1/4"	28"	1
PLSMR318	3	18"	31-1/2"-43"	18"	1

Kidney	# Trays	Diameter	Interior Cabinet Height	Min. Opening	Ctn Qty
PLSMK24	2	24"	21-1/2"-37-1/4"	24"	1
PLSMK28	2	28"	21-1/2"-37-1/4"	28"	1
PLSMK32	2	32"	21-1/2"-37-1/4"	32"	1

Weight Capacity: 20 lb per square foot

Weight Capacity: 20 lb per square foot

Corner Organization: Economy Plastic Lazy Susan Kits

Twist and Lock Pole for Easy Installation



Twist clockwise to lock

Counter clockwise to release



Round	# Trays	Diameter	Interior Cabinet Height	Min. Opening	Ctn Qty
PLSR218	2	18"	21-1/2"–37-1/4"	18"	1
PLSR224	2	24"	21-1/2"–37-1/4"	24"	1
PLSR228	2	28"	21-1/2"–37-1/4"	28"	1
PLSR2318	3	18"	31-1/2"–43"	18"	1

Weight Capacity: 20 lb per square foot



Scan to watch the installation video
<http://delivr.com/2XKDZ>



Twist and Lock Pole



Kidney	# Trays	Diameter	Interior Cabinet Height	Min. Opening	Ctn Qty
PLSK224	2	24"	21-1/2"–37-1/4"	24"	1
PLSK228	2	28"	21-1/2"–37-1/4"	28"	1
PLSK232	2	32"	21-1/2"–37-1/4"	32"	1

Weight Capacity: 20 lb per square foot

Independently rotating shelves featuring smooth surface area

Chrome-plated stainless steel pole with white polymer hubs and adjustable height

Pole features adjustable shelves

Positive stop on kidney shelf units

18" diameter shelves have 1-7/16" overall rim height and 9/16" inside rim height

24" and 28" diameter shelves have 1-7/8" overall rim height and 1" inside rim height

32" diameter shelves have 2-1/8" overall rim height and 1-3/8" inside rim height

Sold as complete set with shelves, poles, mounting hardware and instructions included

Corner Organization: Plastic Pie-cut Lazy Susan



- Door attaches directly to lazy susan
- Available in 24" and 28" diameters
- Patented* height adjustment wheel for fine tuning that is easily accessible
- Cardboard template to streamline installation
- Twist and lock pole
- Designed for inset door application

U.S. PATENTED
9,936,805

Scan to watch the installation video
<http://delivr.com/285UG>



Twist and Lock Pole for Easy Installation



	Description	Dimeter	Height	Standard Cabinet Size	Min. Opening	Ctn Qty
PLSP24	24" Pie-cut lazy susan with 2 shelves	24"	adjustable 25-7/8"-32"	lazy susan base corner	24"	1
PLSP28	28" pie-cut lazy susan with 2 shelves	28"	adjustable 25-7/8"-32"	lazy susan base corner	28"	1

Recommended screw:

installation screws included

Weight Capacity: 20 lb per square foot

Corner Organization: Half-moon Lazy Susan

Cabinet
Organizers

One model for both
left-hand and
right-hand installs

Shelves mount from
underside, for a
clean look and
ease of cleaning

Gives easy access to the
hard to reach areas
of a blind corner

Available in wood
or plastic shelves

Available in 3 sizes:
12", 15" and 18"

U.S. PATENTED
10,111,521



Scan to watch the
installation video

<http://delivr.com/2HX9R>



	Description	Width	Depth	Height	Min. Opening	Standard Cabinet Size	Weight Capacity	Ctn Qty
WOOD SETS	HMLS-W-3212 32" Half-Moon Lazy Susan Set - Wood Trays	31-1/16"	14-1/4"	17-9/16"	11-1/2"	blind corner	110 lb	1
	HMLS-W-3515 35" Half-Moon Lazy Susan Set - Wood Trays	33-9/16"	17-3/16"	17-9/16"	14-1/2"	blind corner	110 lb	1
	HMLS-W-3818 38" Half-Moon Lazy Susan Set - Wood Trays	37-11/16"	19-11/16"	17-9/16"	17-1/2"	blind corner	110 lb	1
PLASTIC SETS	HMLS-P-3212 32" Half-Moon Lazy Susan Set - Plastic Trays	31-1/16"	14-1/4"	18-3/16"	11-1/2"	blind corner	110 lb	1
	HMLS-P-3515 35" Half-Moon Lazy Susan Set - Plastic Trays	33-9/16"	17-3/16"	18-3/16"	14-1/2"	blind corner	110 lb	1
	HMLS-P-3818 38" Half-Moon Lazy Susan Set - Plastic Trays	37-11/16"	19-11/16"	18-3/16"	17-1/2"	blind corner	110 lb	1

Recommended screw:

installation screws included

Lazy Susan Spec Drawings

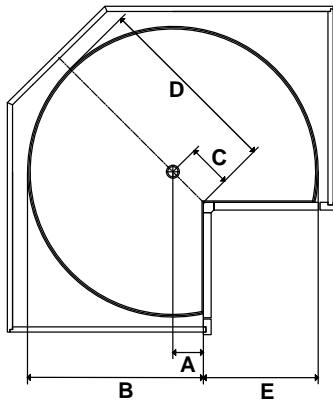

Pie Cut Lazy Susans

Shelf	Series	A	B	C	D	E
24" Pie Cut	PLSP24	1-5/16"	13-3/8"	1-3/4"	13-15/16"	10-5/8" + 1/8" GAP
28" Pie Cut	PLSP28	2-15/16"	16-15/16"	4-5/32"	18-5/32"	11-1/8" + 1/8" GAP

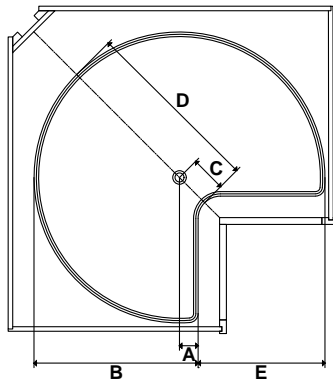

Plastic Lazy Susans - Kidney

Shelf	Series	A	B	C	D	E
24" Kidney	PLSK224	2-1/16"	14-1/16"	3-15/16"	15-15/16"	9-15/16"
28" Kidney	PLSK228	2-1/16"	16-1/16"	3-13/32"	17-13/32"	11-15/16"
32" Kidney	PLSK232	2-1/16"	18-1/16"	3-29/32"	19-29/32"	13-15/16"

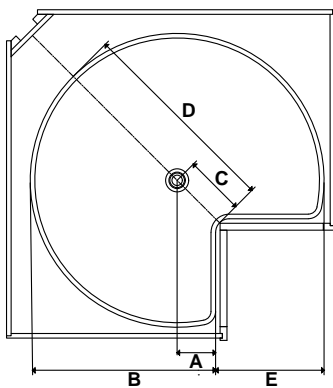

Wood Banded Lazy Susans - Kidney

Shelf	Series	A	B	C	D	E
24" Kidney	BLSK224	1-29/32"	13-29/32"	2-23/32"	14-23/32"	10-3/32"
28" Kidney	BLSK228	3-1/32"	17-1/32"	4-9/32"	18-9/32"	10-31/32"
32" Kidney	BLSK232	4-3/16"	20-3/16"	5-15/16"	21-15/16"	11-13/16"

Lazy Susan Spec Drawings

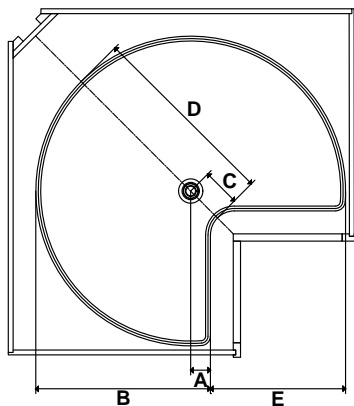

Plastic Lazy Susans with Chrome Metal Hubs

Shelf	Series	A	B	C	D	E
24" Kidney	PLSMK24	2-1/16"	14-1/16"	3-15/16"	15-15/16"	9-15/16"
28" Kidney	PLSMK28	2-1/16"	16-1/16"	3-13/32"	17-13/32"	11-15/16"
32" Kidney	PLSMK32	2-1/16"	18-1/16"	3-29/32"	19-29/32"	13-15/16"

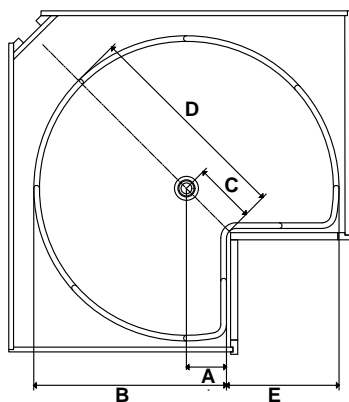

Premium Wood Lazy Susans - Kidney

Shelf	Series	A	B	C	D	E
24" Kidney	LSK224	1-29/32"	13-29/32"	2-23/32"	14-23/32"	10-3/32"
28" Kidney	LSK228	3-1/32"	17-1/32"	4-9/32"	18-9/32"	10-31/32"
32" Kidney	LSK232	4-3/16"	20-3/16"	5-15/16"	21-15/16"	11-13/16"

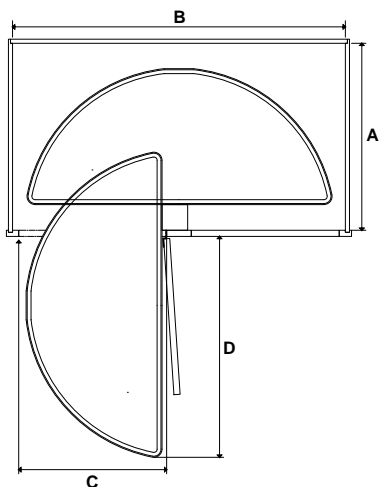

Half-Moon Lazy Susans

Shelf	Series	A	B	C	D
32" Plastic Half-Moon	HMLS-P-3512	22-1/2"	34-1/2"	12"	20-1/2"
35" Plastic Half-Moon	HMLS-P-3515	22-1/2"	37"	15"	22-9/16"
38" Plastic Half-Moon	HMLS-P-3518	22-1/2"	39-1/2"	18"	26-7/8"
32" Wood Half-Moon	HMLS-W-3512	22-1/2"	34-1/2"	12"	20-1/2"
35" Wood Half-Moon	HMLS-W-3515	22-1/2"	37"	15"	22-9/16"
38" Wood Half-Moon	HMLS-W-3518	22-1/2"	39-1/2"	18"	26-7/8"

PANTRY ORGANIZATION



Chrome Pullout
Page 412

Pantry Organization

Organize everyone's favorite spot in the kitchen with a Hardware Resources pantry solution. From the traditional pantry pullout to our innovative pantry swingout, we have a solution for pantry storage needs.



Wood Swingout & Door Mount
Pages 414-415



Chrome Pullout
Page 412



Chrome Swingout
Pages 410-411



Wood Pullout
Page 413

Pantry Organizers: Premium Chrome Swingout

90°
rotating



! Shown using
only 4 baskets.
● 5 baskets included.



Pantry Organizers: Premium Chrome Swingout

Cabinet
Organizers

- Features soft-close slides – 175 lb weight capacity
- Smooth quiet opening and closing motion
- Integrated door mounting brackets*
- Includes 5 heavy duty wire baskets with chrome finish
- Basket placement is adjustable
- Non-slip clear acrylic basket liners included
- Frames adjust to fit variable heights
- Pivots 90° in each direction when fully extended
- For face frame or frameless cabinets**

*If door panel is less than 1/2" thick, additional material may need to be added to the rear of the door

**For face frame cabinet installation, additional cabinet blocking will be required for top mounting bracket.

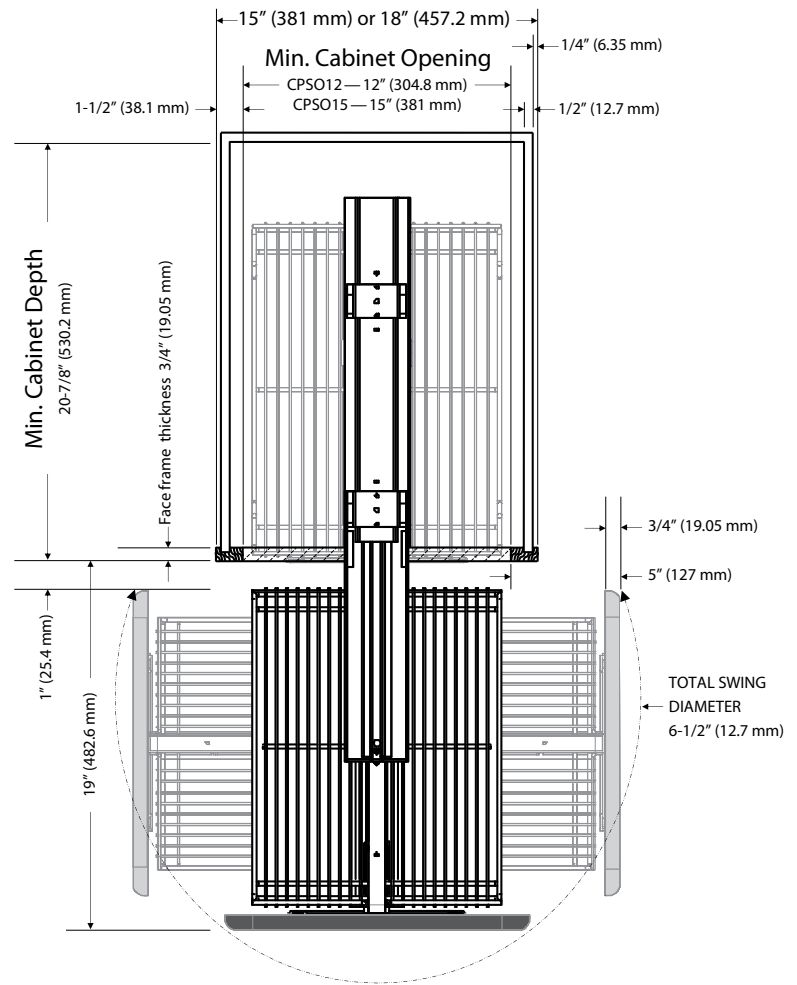

Scan to watch the
installation video
<http://delivr.com/2m8fn>



**FRAMELESS
FRIENDLY!**

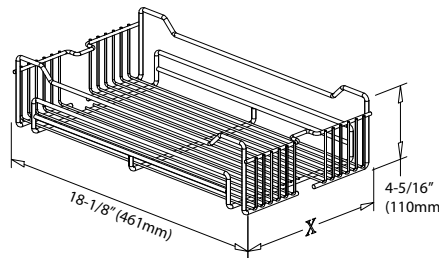

Cab. Opening	Basket Width (X)
For 12" opening	9-5/8" (254mm)
For 15" opening	13-1/2" (345mm)

	Width	Depth	Height	# of Baskets	Standard Cabinet Size	Weight Capacity	Ctn Qty
CPSO1274SC	9-7/8"	19-3/8"	61-7/16" to 74-13/16"	5	15" pantry with 12" opening	175 lb	1
CPSO1286SC	9-7/8"	19-3/8"	73-1/4" to 86-5/8"	5	15" pantry with 12" opening	175 lb	1
CPSO1574SC	13-9/16"	19-3/8"	61-7/16" to 74-13/16"	5	18" pantry with 15" opening	175 lb	1
CPSO1586SC	13-9/16"	19-3/8"	73-1/4" to 86-5/8"	5	18" pantry with 15" opening	175 lb	1

Recommended screw:

#6 pan head

Pantry Organizers: Premium Chrome Pullout



- Features soft-close slides – 175 lb total weight capacity
- Smooth quiet opening and closing motion
- Integrated door mounting brackets*
- Heavy duty wire baskets with chrome finish and non-slip clear acrylic basket liners
- Basket placement is adjustable
- Frames adjust to fit variable heights
- Extends fully out of the cabinet
- For face frame or frameless cabinets**

*If door panel is less than 1/2" thick, additional material may need to be added to the rear of the door

**For face frame cabinet installation, additional cabinet blocking will be required for top mounting bracket.



Scan to watch the
installation video
<http://delivr.com/2s8ay>

**FRAMELESS
FRIENDLY!**

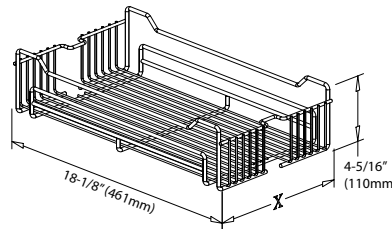

Cab. Opening	Basket Width (X)
For 12" opening	9-5/8" (245 mm)
For 15" opening	13-1/2" (345 mm)
For 18" opening	17-1/2" (445 mm)

	Width	Depth	Height	# Baskets	Standard Cabinet Size	Min. Opening	Weight Capacity	Ctn Qty
CPPO1263SC	9-7/8"	19-3/8"	49-5/8" to 63"	4	15" pantry with 12" opening	9-7/8"	175 lb	1
CPPO1274SC	9-7/8"	19-3/8"	61-7/16" to 74-13/16"	5	15" pantry with 12" opening	9-7/8"	175 lb	1
CPPO1286SC	9-7/8"	19-3/8"	73-1/4" to 86-5/8"	5	15" pantry with 12" opening	9-7/8"	175 lb	1
CPPO1563SC	13-9/16"	19-3/8"	49-5/8" to 63"	4	18" pantry with 15" opening	13-9/16"	175 lb	1
CPPO1574SC	13-9/16"	19-3/8"	61-7/16" to 74-13/16"	5	18" pantry with 15" opening	13-9/16"	175 lb	1
CPPO1586SC	13-9/16"	19-3/8"	73-1/4" to 86-5/8"	5	18" pantry with 15" opening	13-9/16"	175 lb	1
CPPO2063SC	17-1/2"	19-3/8"	49-5/8" to 63"	4	23" pantry with 20" opening	17-1/2"	175 lb	1
CPPO2074SC	17-1/2"	19-3/8"	61-7/16" to 74-13/16"	5	23" pantry with 20" opening	17-1/2"	175 lb	1
CPPO2086SC	17-1/2"	19-3/8"	73-1/4" to 86-5/8"	5	23" pantry with 20" opening	17-1/2"	175 lb	1

Recommended screw:

#6 pan head

Pantry Organizers: Wood Pullout

Cabinet
Organizers



- Solid white birch plywood construction with clear UV Finish
- Top shelf and bottom 2 shelves are fixed
- 2 adjustable middle shelves
- Ships preassembled and installs quickly
- Patented* top mounting bracket eliminates side-to-side movement and sag
- Top mounting bracket allows for 3" of adjustability and can be used for frameless or face frame cabinetry
- 400 lb heavy duty ball bearing bottom slides and 225 lb ball bearing top slide
- Patented* Integrated 6-way adjustable door mounting brackets allow for easy mounting of door

**FRAMELESS
FRIENDLY!**

U.S. PATENTED
9,565,936 & 9,661,924
& 10,028,581



Scan to watch the
installation video
<http://delivr.com/2ZRYV>



	Width	Depth	Height	# Shelves	Standard Cabinet Size	Min. Opening	Weight Capacity	Ctn Qty
PPO2-548	5-1/2"	22-1/2"	46" to 49"	5	9" pantry with 6" opening	5-1/2"	400 lb	1
PPO2-554	5-1/2"	22-1/2"	52" to 55"	5	9" pantry with 6" opening	5-1/2"	400 lb	1
PPO2-560	5-1/2"	22-1/2"	59" to 62"	5	9" pantry with 6" opening	5-1/2"	400 lb	1
PPO2-848	8-1/2"	22-1/2"	46" to 49"	5	12" pantry with 9" opening	8-1/2"	400 lb	1
PPO2-854	8-1/2"	22-1/2"	52" to 55"	5	12" pantry with 9" opening	8-1/2"	400 lb	1
PPO2-860	8-1/2"	22-1/2"	59" to 62"	5	12" pantry with 9" opening	8-1/2"	400 lb	1
PPO2-1148	11-1/2"	22-1/2"	46" to 49"	5	15" pantry with 12" opening	11-1/2"	400 lb	1
PPO2-1154	11-1/2"	22-1/2"	52" to 55"	5	15" pantry with 12" opening	11-1/2"	400 lb	1
PPO2-1160	11-1/2"	22-1/2"	59" to 62"	5	15" pantry with 12" opening	11-1/2"	400 lb	1
PPO2-1448	14-1/2"	22-1/2"	46" to 49"	5	18" pantry with 15" opening	14-1/2"	400 lb	1
PPO2-1454	14-1/2"	22-1/2"	52" to 55"	5	18" pantry with 15" opening	14-1/2"	400 lb	1
PPO2-1460	14-1/2"	22-1/2"	59" to 62"	5	18" pantry with 15" opening	14-1/2"	400 lb	1

Recommended screw:

#6 pan head



Extra Rails Ctn Qty

RAIL-17-PC Extra rail for PPO2 series 50

hardware
resources

800.463.0660 | www.HardwareResources.com

[415]

Pantry Organizers: Wood Swingout



Used in pantry cabinets with recessed center divider
 Minimum opening 33" wide
 Top shelf and bottom 2 shelves are fixed
 2 adjustable middle shelves
 Piano hinge allows left and right shelves to swing out
 Solid birch and birch plywood construction with clear UV finish
 Wings ship preassembled to center mounting strip



Scan to watch the installation video
<http://delivr.com/2fz83>



Extra Rails

	Length	Height	Ctn Qty
RAIL-9-PC	9-1/4"	1-3/4"	50

	Length	Height	Ctn Qty
RAIL-9-PC	9-1/4"	1-3/4"	50

	Width	Depth	Height	Standard Cabinet Size	Ctn Qty
A PSO45	25-15/16"	8"	45-5/8"	36" pantry	1

Recommended screw: #8 flat head

Pantry Organizers: Wood Door Mount

Cabinet
Organizers



Mounts to the inside of hinged pantry doors, minimum 48" tall and 13" wide

Three adjustable middle shelves

Solid birch and birch plywood construction with clear UV finish

Ships preassembled and quickly installs to cabinet door, as shown on opposite page

Can be used in conjunction with Pantry Swingout



B

	Width	Depth	Height	Standard Cabinet Size	Ctn Qty
B PDM45	12"	4-7/8"	45-5/8"	18" pantry door	1

Recommended screw: #8 flat head

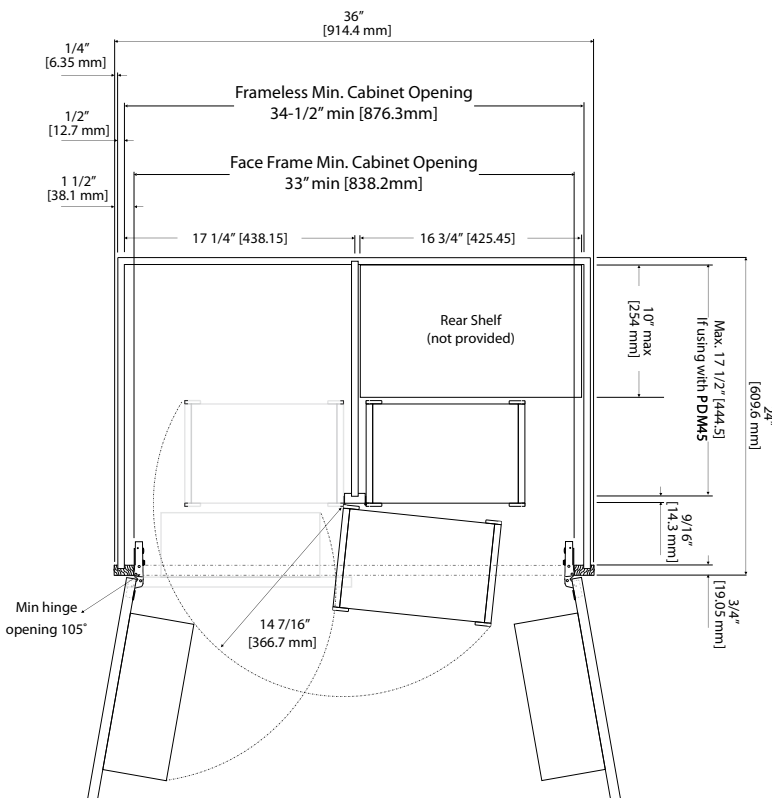

Extra Rails	Length	Height	Ctn Qty
RAIL-9-PC	9-1/4"	1-3/4"	50

DRAWER ORGANIZATION



NEW Angled Cutlery Drawer
Page 423

Drawer Organization

Tame drawer clutter with Hardware Resources' drawer organizers. From complete drawer organization to drop-in inserts, these products will help organize everything from cutlery to cookware.

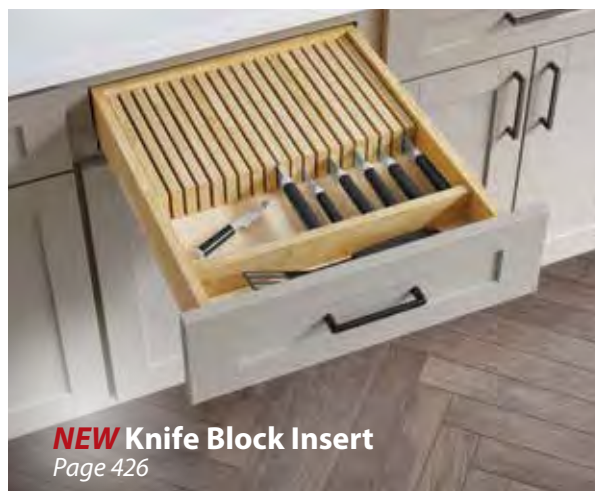
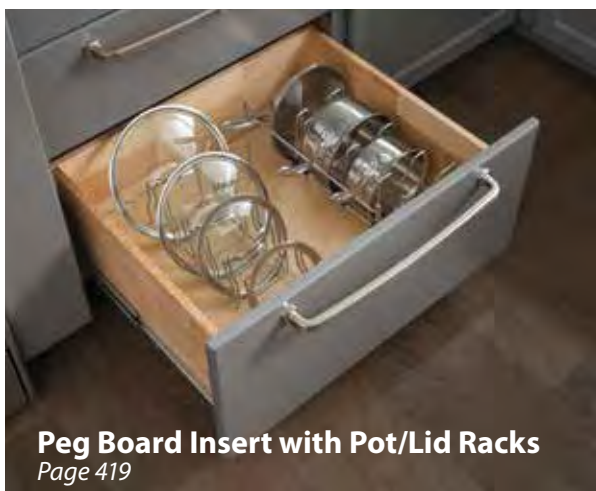

Drawer Organizers: Peg Board Insert



	# Pegs	Width	Depth	Height	Ctn Qty
PEG-9*	9	24-1/4"	21-1/4"	6-5/8"	1
PEG-12*	12	30-1/4"	21-1/4"	6-5/8"	1
PEG-16*	16	39-1/4"	21-1/4"	6-5/8"	1

*Item can be trimmed to fit smaller drawer

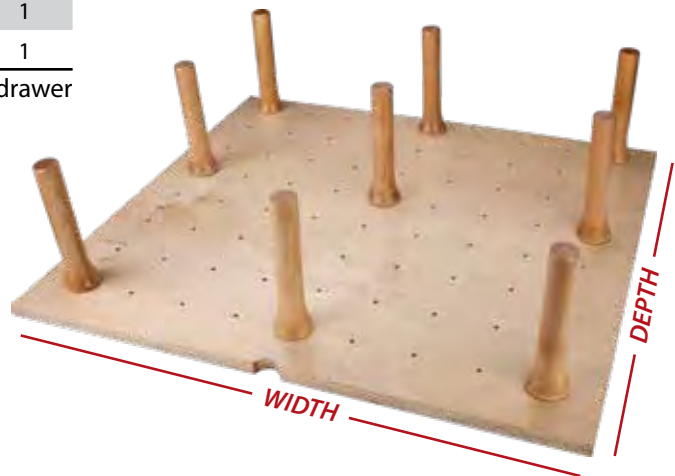

- Pegs included - see table above for quantity
- Solid 5/8" birch plywood bottom panel with clear UV finish
- Press-in solid birch pegs with clear UV finish
- Ideal storage for dinnerware or plastic containers
- Designed to drop into a drawer with no installation needed
- All sizes can be trimmed to fit



Additional Pegs	# Pegs	Top Diameter	Bottom Diameter	Height	Ctn Qty
PEG-BOX	4	1"	1-5/8"	6"	1

Press-in solid birch pegs with clear UV finish
Use with PEG-9, PEG-12 or PEG-16

Drawer Organizers: Peg Board Accessories

Cabinet
Organizers



Tame drawer clutter and offer an adjustable storage solution for pots/pans and lids with our pegboard accessories. Designed to work with our PEG-9, PEG-12 and PEG-16 peg board drawer inserts in deep drawers, our pot/pan organizer and lid organizer allows you to keep multiple sizes of cookware neat and organized. Featuring easy press-in installation. Cookware is always within reach.

Pot/Pan Organizer

- Holds up to five pots or pans and includes a handle rest
- Adjustable dividers can be moved for a variety of configurations
- Can be combined with Lid Organizer PEG-LO
- Use with PEG-9, PEG-12 or PEG-16
- Designed to drop into a drawer with no installation needed

Lid Organizer

- Holds six lids
- Can be combined with Pot Organizer PEG-PO
- Use with PEG-9, PEG-12 or PEG-16
- Designed to drop into a drawer with no installation needed



	<i>Description</i>	<i>Width</i>	<i>Depth</i>	<i>Height</i>	<i>Ctn Qty</i>
A	PEG-PO Pot Organizer	5-3/8"	15-3/16"	6-5/8"	1
B	PEG-LO Lid Organizer	5-3/16"	16-7/16"	5-7/16"	1

Drawer Organizers: Double Cutlery Drawer



Scan to watch the
installation video
<http://delivr.com/2r2j4>

Make the most of space with this two tier system

Top tier includes preassembled full extension ball bearing slides: 100 lb slides on 4-3/16" units

Item numbers with P include push-to-open slides on top tray

Ships notched and bored for recommended use with USE58-300 undermount drawer slides (sold separately)

Drawer front not included

Made from 1/2" solid white birch dovetail drawer sides and 1/4" prefinished birch plywood bottoms, all with clear UV finish



	Width	Depth	Height	Slide	Min Opening	Standard Cabinet Size	Weight Capacity	Ctn Qty
CD15	11-1/2"	21"	4-3/16"	100 lb	11-1/2"	15" base	100 lb	1
CD18	14-1/2"	21"	4-3/16"	100 lb	14-1/2"	18" base	100 lb	1
CD18P [†]	14-1/2"	21"	4-3/16"	100 lb Push	-	18" base	-	1
CD21	17-1/2"	21"	4-3/16"	100 lb	17-1/2"	21" base	100 lb	1
CD24	20-1/2"	21"	4-3/16"	100 lb	20-1/2"	24" base	100 lb	1
CD24P [†]	20-1/2"	21"	4-3/16"	100 lb Push	-	24" base	-	1



These products are being retired.
Call for availability on products marked with "†".

NEW

Drawer Organizers: Angled Cutlery Insert

**Cabinet
Organizers**



	Width	Depth	Height	Recommended Drawer	Ctn Qty
AU021-B24	19-3/16"	19-1/2"	2-1/2"	21" wide drawer*	5

*Item can be trimmed to fit smaller drawer

Large 4" divider sections perfect for storing larger cooking utensils

Designed to drop into a drawer with no installation needed

Transition piece is included to use multiple inserts in wider drawers for a seamless look





DO21A-B24 Shown

NEW

Drawer Organizers: Cutlery Insert

**Cabinet
Organizers**



DO15A-B18 Shown



	Width	Depth	Height	Recommended Drawer	Ctn Qty
DO15A-B18*	13-7/16"	19-1/2"	2-3/8"	15" wide drawer*	5
DO21A-B24*	19-1/2"	19-1/2"	2-3/8"	21" wide drawer*	5

*Item can be trimmed to fit smaller drawer

Adjustable width allows inserts to fit a variety of sized drawers

DO15A-B18 is adjustable from 9-5/8" Min to 13-7/16" Max

DO21A-B24 is adjustable from 15-5/8" Min to 19-1/2" Max

Cutlery sections are 2-3/8" wide

2-3/8" total height

Sized to fit 15" and 21" drawers with no trimming needed

Transition piece is included to use multiple inserts in wider drawers for a seamless look



NEW

Drawer Organizers: Knife Block Insert



SHIPS FULLY ASSEMBLED

	Width	Depth	Height	Ctn Qty
KO18-B21*	16-3/16"	19-1/2"	2-3/8"	5

*Item can be trimmed to fit smaller drawer

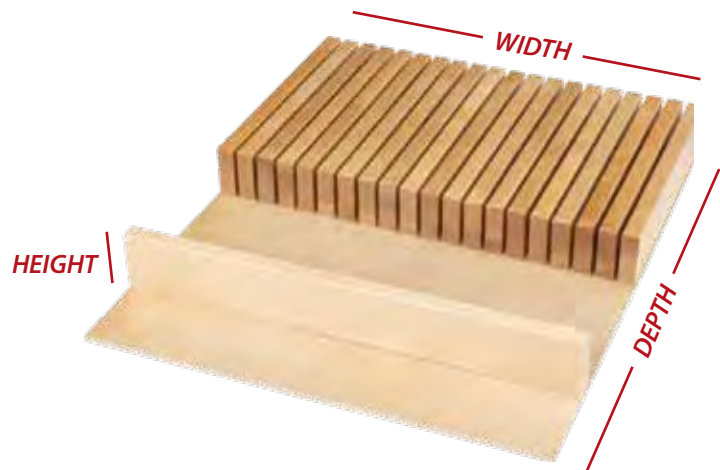

- For use in 18" wide drawer
- Comes with 19 knife slots and built-in front storage partition
- Solid birch and birch plywood construction with clear UV finish
- Transition piece is included to use multiple inserts in wider drawers for a seamless look
- Designed to drop into a drawer with no installation needed

NEW

Drawer Organizers: Spice Tray Insert

**Cabinet
Organizers**



	<i>Width</i>	<i>Depth</i>	<i>Height</i>	<i>Ctn Qty</i>
SPO15-B18*	13-3/16"	19-1/2"	13/16"	5
SPO24-B27*	22-1/4"	19-1/2"	13/16"	5

*Item can be trimmed to fit smaller drawer

- Holds wide variety of spice jars and containers
- For use in 15" or 24" drawers, or trim to size
- Solid birch and birch plywood construction with clear UV finish
- Transition piece is included to use multiple inserts in wider drawers for a seamless look
- Designed to drop into a drawer with no installation needed

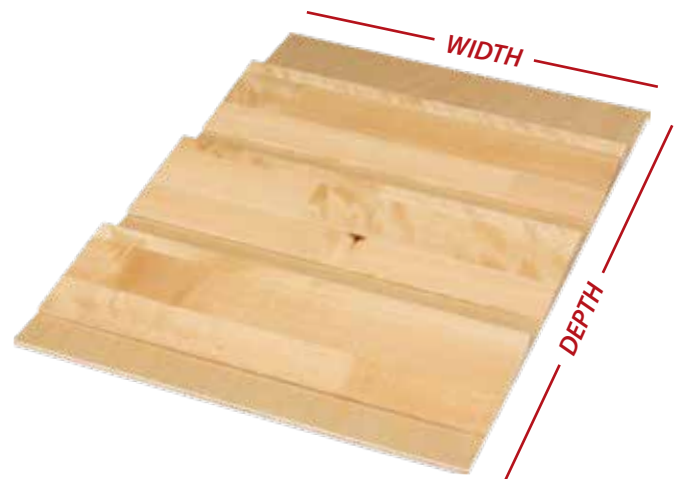

Tipout Tray: Stainless Steel



! Shown using 2 hinges. Kit includes 4 hinges for installation on 1 or 2 fronts.

- Convert false front drawers into useful hidden storage space
- Sold as kits or individual trays and hinge pairs
- Each kit includes 2 trays, 4 hinges, and screws
- Stainless steel is durable and easily cleaned
- Ships with all necessary hinges and screws
- Hinges are self closing and feature adjustable opening angle
- 1-9/16" slim depth trays are great for use in low clearance applications behind large sinks



Kits	Width	Depth	Height	Standard Cabinet Size	Ctn Qty
TOSS11-R	11"	2"	3"	36" base	4 kits
TOSS11S-R	11"	1-9/16"	3"	36" base	4 kits
TOSS14-R	14"	2"	3"	36" base	4 kits
TOSS14S-R	14"	1-9/16"	3"	36" base	4 kits

Kit includes 2 trays, 4 hinges & installation screws

Individual Items

	Width	Depth	Height	Ctn Qty
TOSS11-REPL	11"	2"	3"	1 tray
TOSS11S-REPL	11"	1-9/16"	3"	1 tray
TOSS14-REPL	14"	2"	3"	1 tray
TOSS14S-REPL	14"	1-9/16"	3"	1 tray
TIPOUT-HINGE	-	-	-	1 pair

Tipout Tray: White

Cabinet
Organizers



- Convert false front drawers into useful hidden storage space
- Sold as kits or individual trays and hinge pairs
- Each kit includes 2 trays, 4 hinges, and screws
- White polymer is durable and easily cleaned
- Ships with all necessary hinges and screws
- Hinges are self closing and feature adjustable opening angle
- 1-9/16" slim depth trays are great for use in low clearance applications behind large sinks



Kits	Width	Depth	Height	Standard Cabinet Size	Ctn Qty
TO11-R	11"	2"	3"	36" base	4 kits
TO11S-R	11"	1-9/16"	3"	36" base	4 kits
TO14-R	14"	2"	3"	36" base	4 kits
TO14S-R	14"	1-9/16"	3"	36" base	4 kits

Kit includes 2 trays, 4 hinges & installation screws

Individual Items

	Width	Depth	Height	Ctn Qty
TO11-REPL	11"	2"	3"	1 tray
TO11S-REPL	11"	1-9/16"	3"	1 tray
TO14-REPL	14"	2"	3"	1 tray
TO14S-REPL	14"	1-9/16"	3"	1 tray
TIPOUT-HINGE	-	-	-	1 pair

WALL ORGANIZATION



"No Wiggle" Wall Cabinet Pullout
Page 430



Smart Rail® Storage Solution
Pages 432-435



Wire Tray Divider
Page 436

Wall Cabinet Organization

Maximize cabinet storage with Hardware Resources' wall cabinet organizers. From cabinet pullouts and bakeware organizers to spice racks and wine accessories, we can help you make the most beautiful and organized kitchen.



Wall Filler Pullout
Page 431

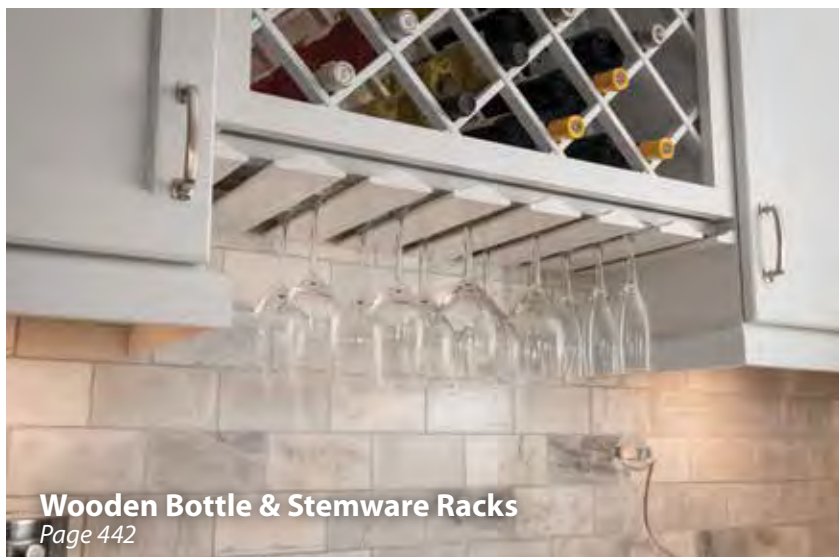

Wooden Bottle & Stemware Racks
Page 442

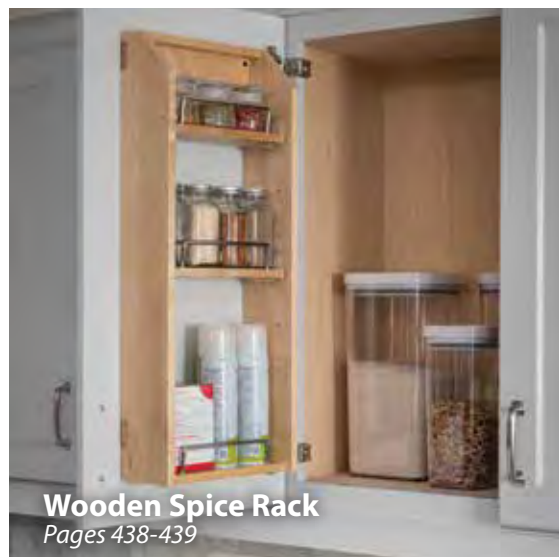

Wooden Spice Rack
Pages 438-439

Wall Cabinet Organization: "No Wiggle" Wall Pullout



- Built on our "No Wiggle" platform
- Patented* top mounting bracket eliminates excessive side-to-side movement and sag, yet is hidden under the first shelf for a clean look
- Bottom slides are concealed undermount slides, and the top is a 100 lb slide for added support and weight bearing
- Patented* integrated 6-way adjustable door-mounting brackets allow for easy mounting of door
- Two adjustable shelves included
- Frameless Friendly! Works in both face frame and frameless applications
- Ships fully assembled making installation a breeze



9,661,924 & 9,723,922
10,028,581 & 10,251,480

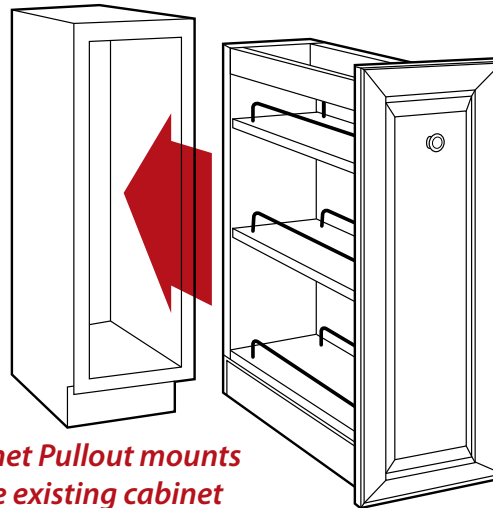

Cabinet Pullout mounts inside existing cabinet

door front not included

	Width	Depth	Height	Min. Opening	Standard Cabinet Size	Weight Capacity	Ctn Qty
WPO2-5SC	5-7/16"	11-5/16"	24"	5-1/2"	9" wall	100 lb	1
WPO2-8SC	8-7/16"	11-5/16"	24"	8-1/2"	12" wall	100 lb	1

Recommended screw: #8 flat head

Wall Cabinet Organization: Wall Filler Pullout

Cabinet
Organizers

- Used in 3" and 6" wide wall cabinet applications
- Installs in dead space between wall cabinets
- Two adjustable middle shelves
- Solid birch and birch plywood construction with clear UV finish
- Featuring 303FU Series full extension 100 lb ball bearing slides
- Ships preassembled and quickly installs to adjacent wall cabinets using predrilled pilot holes



	Width	Depth	Height	Min. Opening	Weight Capacity	Ctn Qty
WFPO330	3"	11-1/8"	30"	3"	50 lb	1
WFPO630	6"	11-1/8"	30"	6"	50 lb	1
WFPO336	3"	11-1/8"	36"	3"	50 lb	1
WFPO636	6"	11-1/8"	36"	6"	50 lb	1
WFPO342	3"	11-1/8"	42"	3"	50 lb	1
WFPO642	6"	11-1/8"	42"	6"	50 lb	1

Recommended screw: #6 face frame



Extra Shelves & Rails

		Ctn Qty
WFPO3-ES	Extra shelf for 3" WFPO	1
WFPO6-ES	Extra shelf for 6" WFPO	1
RAIL-7-PC	Extra rail for WFPO series	50

Wall Filler Pullout shown
mounted between 2 cabinets

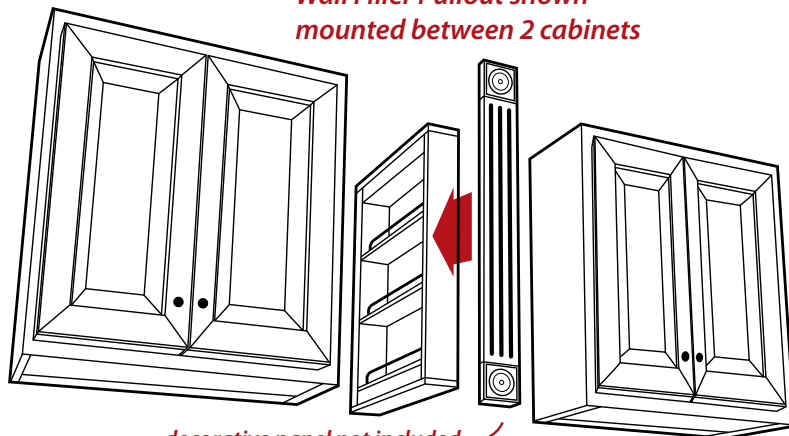

decorative panel not included
See the Hardware Resources Wood Products catalog or
www.HardwareResources.com for more information.

Wall Cabinet Organization: Smart Rail® Storage Solution



Wall Cabinet Organization: Smart Rail® Storage Solution



Pieces sold individually

Fully customizable modular system

Rail attaches to wall with included cleats and screws

All accessories lock into a groove on the rail, and position can be adjusted and multiple accessories used

Stylish brushed aluminum finish with bamboo accents

Mount Smart Rail above stove, under wall cabinets or in place of wall cabinets



Rails

	Description	Width	Depth	Height	Min. Opening	Weight Capacity	Ctn Qty
SRSS999	Hang Rail for Smart Rail® Storage Solution	35-7/16"	1-1/2"	1-3/8"	35-7/16"	45 lb	1

Wall Cabinet Organization: Smart Rail® Storage Solution



	Description	Width	Depth	Height	Ctn Qty
C	SRSS960-BAM Hanging Cutting Board for Smart Rail® Storage Solution	19"	1-3/8"	10-1/4"	1
D	SRSS940-BAM Knife-Block Combo Hanging Shelf for Smart Rail® Storage Solution	13-3/4"	5-1/2"	12"	1



	Description	Width	Depth	Height	Ctn Qty
E	SRSS950-BAM Hanging Paper Towel Holder for Smart Rail® Storage Solution	15-3/4"	5-3/16"	4"	1
F	SRSS970-BAM Hanging 5 Hook Shelf for Smart Rail® Storage Solution	17-1/2"	1-1/2"	4"	1

Wall Cabinet Organization: Smart Rail® Storage Solution



	Description	Width	Depth	Height	Ctn Qty
G	SRSS980-BAM Hanging 5 Spice Bottle Shelf for Smart Rail® Storage Solution	17-1/2"	2"	4"	1
H	SRSS920-BAM Single Hanging Shelf for Smart Rail® Storage Solution	13-3/4"	4-1/2"	8"	1



	Description	Width	Depth	Height	Ctn Qty
J	SRSS910 Single Top Shelf for Smart Rail® Storage Solution	13-13/16"	4-3/8"	13/16"	1
K	SRSS900-BAM Single Hook for Smart Rail® Storage Solution	1-13/16"	1-13/16"	1-7/16"	1
L	SRSS930-BAM Canister Hanging Shelf for Smart Rail® Storage Solution	13-3/4"	4-1/2"	12"	1

Wall Cabinet Organization: Wire Tray Divider



Easily and quickly installs with four screws (included)

Completely versatile organization – use multiple tray dividers and mix and match sizes to customize your storage

Place multiple dividers at any spacing – narrow for baking sheets and wider for cutting boards and baking dishes

Polished Chrome finish

Sold individually

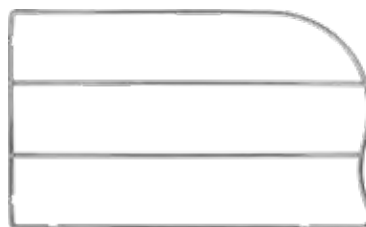

TD12-PC

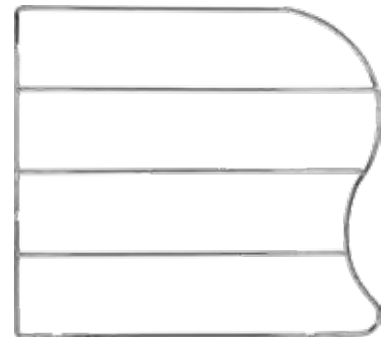

TD18-PC

	Width	Depth	Height	Standard Cab. Size	Ctn Qty
TD12-PC	1/4"	20"	12"	base or pantry	1
TD18-PC	1/4"	20"	18"	base or pantry	1

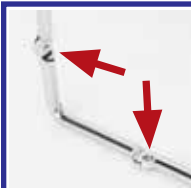

Mounts quickly to the cabinet floor and back wall with 4 screws

Wall Cabinet Organization: Wooden Tray Divider

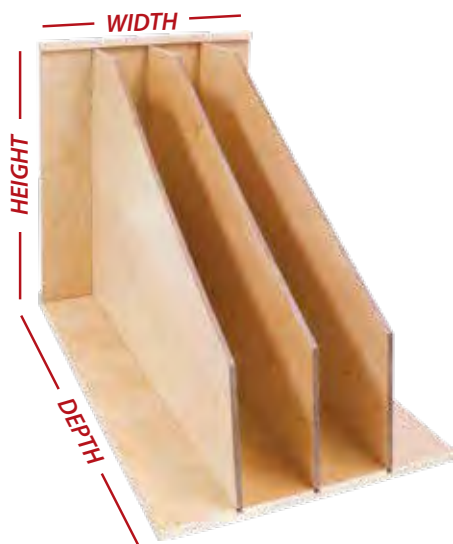

Stores pans, platters, plates, and baking sheets

For 24" depth and 12" width cabinets (can be trimmed to smaller width)

Three removable dividers insert to allow 4 separate storage units with 2-3/4" interior storage width

Solid birch and birch plywood construction with clear UV finish

Ships flat pack

Easy to assemble



	Width	Depth	Height	Standard Cab. Size	Ctn Qty
TD3	11-3/4"	22-1/4"	16"	15" base or pantry	5

Recommended screw:

#8 flat head

Wall Cabinet Organization: Door Mounted Spice Racks



Wall Cabinet Organization: Door Mounted Spice Racks

Door Mount Spice Rack with Adjustable Shelves

Installs to back of cabinet door and holds a wide variety of spice jars, containers, and bottles

Ships with two support rails (22-3/8", 25-3/8", or 28-3/8" wide) which can be cut to size and allow installation to door stile

Three shelves: lower shelf is fixed, and two upper shelves are adjustable

Solid birch and birch plywood construction with clear UV finish



	Width	Depth	Height	Min. Opening	Standard Cab. Size	Ctn Qty
SPR9A	9-1/2"	4"	24"	12"	15" wall or base	5
SPR12A	12-1/2"	4"	24"	15"	18" wall or base	5
SPR15A	15-1/2"	4"	24"	18"	21" wall or base	5

Recommended screw: #8 pan head

Extra Rails

	Length	Height	Ctn Qty	Use with HR Part #
RAIL-9-PC	9-1/4"	1-3/4"	50	SPR12A
RAIL-12-PC	12-1/4"	1-3/4"	50	SPR15A



works great for bathrooms too!

Wall Cabinet Organization: Wooden Stemware Rack



Wooden Stemware Rack

- Used in 18", 30" or 36" wide spaces to hold 4, 7 or 8 rows of glasses
- For 12" deep cabinets (width and depth can be trimmed to fit smaller applications)
- Solid wood is sanded and can be finished to match the application
- Quickly installs using #6 x 1" pan head screws (provided)

	Species	Rows	Width	Depth	Height	Ctn Qty
SR18	Maple	4	18"	12"	1-1/2"	5
SR18ALD [†]	Alder	4	18"	12"	1-1/2"	5
SR30	Maple	7	30"	12"	1-1/2"	5
SR30ALD [†]	Alder	7	30"	12"	1-1/2"	5
SR36	Maple	8	36"	12"	1-1/2"	5



Build your own stemware rack

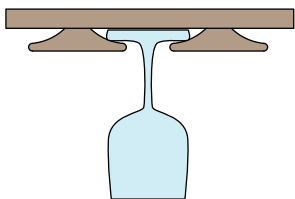

Wooden Stemware Moulding

- Cut to any length
- Priced by the linear foot, sold in 8' lengths

	Species	Width	Depth	Ctn Qty
STMW-ALD	Alder	3-3/16"	3/4"	40 LF
STMW-HMP	Hard Maple	3-3/16"	3/4"	40 LF

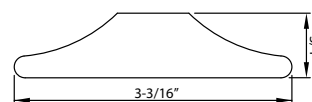

 These products are being retired. Call for availability on products marked with "†".

Wall Cabinet Organization: Wooden Wine Bottle Lattice

Can be cut to size
Beveled mouldings with routed face
Mouldings are 5/8" thick x 3/4" wide
3-3/4" x 3-3/4" bottle openings
Solid wood is sanded and can be finished
to match the application
Sold by the piece

	<i>Species</i>	<i>Width</i>	<i>Height</i>	<i>Ctn Qty</i>
WR30-2ALD	Alder	24"	30"	10
WR30-2MP	Maple	24"	30"	10
WR30-2OK	Oak	24"	30"	10
WR45-2ALD	Alder	25"	45"	10
WR45-2MP	Maple	25"	45"	10
WR45-2OK	Oak	25"	45"	10
WR48-2ALD	Alder	36"	48"	10
WR48-2MP	Maple	36"	48"	10
WR48-2OK	Oak	36"	48"	10

Recommended screw: #6 flat head

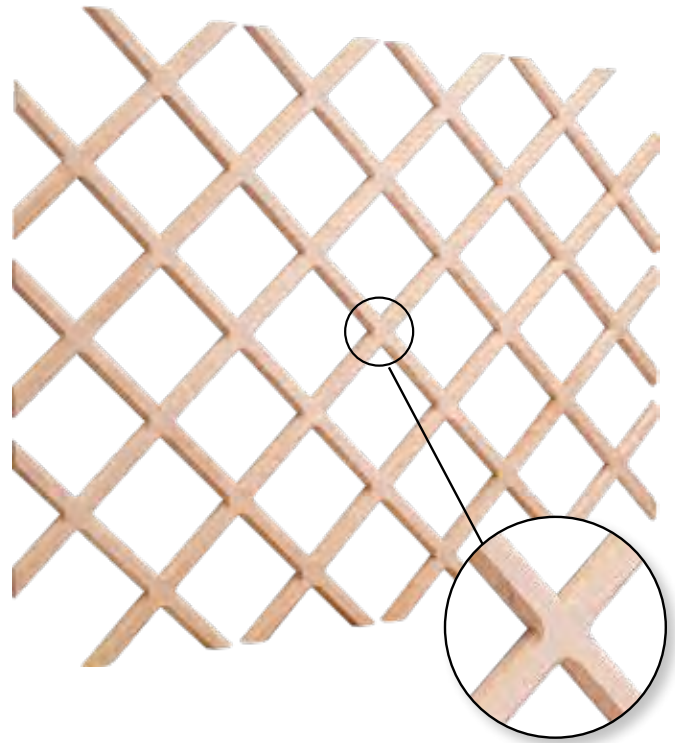

Can be cut to size
Mouldings are 3/4" thick x 7/16" wide
4" x 4" bottle openings
Solid maple is sanded and can be finished
to match the application
Sold by the piece

	<i>Species</i>	<i>Width</i>	<i>Height</i>	<i>Ctn Qty</i>
WR30MP	Maple	24"	30"	10
WR36MP	Maple	36"	36"	10

Recommended screw: #6 flat head

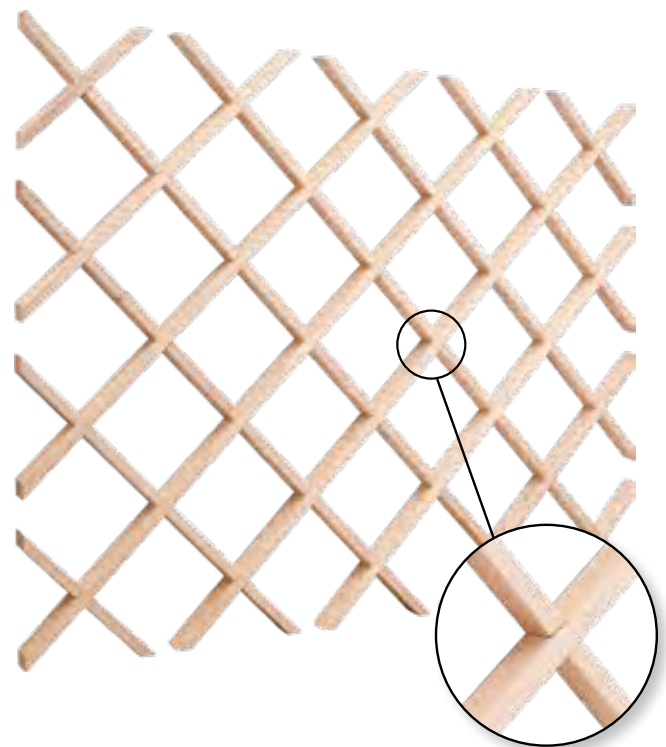

Wall Cabinet Organization: Wooden Bottle Rack & Wire Stemware



Wire Stemware Rack

- Thick wire gauge construction
- Under-cabinet mount with hidden installation holes
- Screws not included

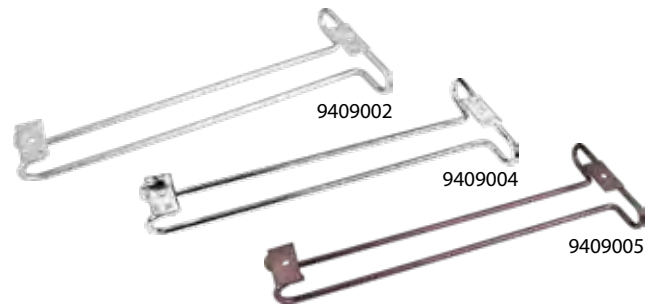

	Finish	Front Width	Rear Width	Length	Ctn Qty
9409002	Satin Chrome	4"	1-3/8"	11-7/16"	100
9409004	Polished Chrome	4"	1-3/8"	11-7/16"	100
9409005	Brushed Oil Rubbed Bronze	4"	1-3/8"	11-7/16"	100

Recommended screw: #6 flat head



Wooden Bottle Rack

- Use in 24", 30" or 48" wide spaces to hold 5, 6 or 10 bottles
- Can also be trimmed to fit into 18" minimum spaces
- Install to base of cabinet or multiple units can be stacked
- Solid wood is sanded and can be finished to match the application
- Ships with front and back rails
- Screws not included

	Species	# Bottles	Width	Depth	Height	Ctn Qty
BR24	Maple	5	24"	3/4"	2"	20
BR24ALD [†]	Alder	5	24"	3/4"	2"	20
BR30	Maple	6	30"	3/4"	2"	20
BR48	Maple	10	48"	3/4"	2"	20
BR48ALD [†]	Alder	10	48"	3/4"	2"	20

Recommended screw: #8 flat head



These products are being retired.
Call for availability on products marked with "†".

Easy-to-install
**CABINET
ORGANIZERS**

Organize Your Kitchen in
11 minutes
or less™





It's That Easy!



1 Measure

Measure your cabinet's interior width, depth and height. Hold your tape parallel to the cabinet's walls. Note any pipes, shelves, or hinges that may affect actual available space.



2 Set

Set your organizer in place making sure you can open and close the cabinet door easily. If the organizer installs on the cabinet door, consider marking two points to help with alignment.



3 Secure

Using your Phillips screwdriver and the screws provided, secure your organizer in place.

Measuring Tape

Phillips Screwdriver

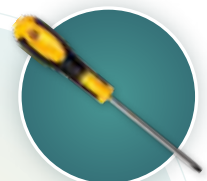

All you need:



Pencil (optional)



11 Minutes!

Retail packed with easy installation instructions and hardware

Recommended standard cabinet sizes & opening sizes

Lifetime warranty

Minimal tools required

Installs with 4 screws or less

Minimum opening & cabinet sizes

Trilingual: English, Spanish, French

Product dimensions

Features & benefits

Easy installation

QR code link to more information

Organize Your Kitchen in **11 minutes** or less 

Pullout Baskets

Easy Install Organizers

Retail Packaged



Great for organizing your cookware or pantry
Full extension ball bearing slides

Heavy duty wire construction
Quickly mounts to cabinet floor or fixed shelf using four screws (included)

	Description	Finish	Width	Depth	Height	Min. Opening	Fits Standard Cabinet Size	Weight Capacity	Ctn Qty
MBPO15-R	Pullout Basket	Polished Chrome	11-3/8"	19-11/16"	6-3/16"	11-1/2"	15" base	50 lb	3
MBPO18-R	Pullout Basket	Polished Chrome	14-3/8"	19-11/16"	6-3/16"	14-1/2"	18" base	50 lb	3
MBPO21-R	Pullout Basket	Polished Chrome	17-3/8"	19-11/16"	6-3/16"	17-1/2"	21" - 24" base	50 lb	3

Trash Can Pullout

Organize Your Kitchen in **11 minutes** or less



Retail Packaged



Cans Sold Separately

Use optional door mounting kit for door pullout application

- Heavy duty 100 lb full extension ball bearing slides
- Thick wire frame construction
- Durable polymer trash cans are easily cleaned
- Cans and lids sold separately
- Quickly mounts to cabinet floor using four screws (included)

- Wire handle included
- Optional 6-way adjustable door mounting kit for door pullout application
- Retail packed with English, French and Spanish translations
- Note:** Double 50 qt unit requires full height cabinet

	Description	Finish	Width	Depth	Height	Min. Opening	Standard Cabinet Size	Weight Capacity	Ctn Qty
CAN-EBMSB-R	Single Can Unit - 35 or 50 qt	Black	10-1/4"	22-1/16"	13"	10-1/4"	15" base	50 lb	6
CAN-EBMSPC-R	Single Can Unit - 35 or 50 qt	Polished Chrome	10-1/4"	22-1/16"	13"	10-1/4"	15" base	50 lb	6
CAN-EBMSW-R	Single Can Unit - 35 or 50 qt	White	10-1/4"	22-1/16"	13"	10-1/4"	15" base	50 lb	6
CAN-EBMDB-R	Double Can Unit - 35 qt only	Black	13-15/16"	22"	13"	13-15/16"	18" base	50 lb	4
CAN-EBMDPC-R	Double Can Unit - 35 qt only	Polished Chrome	13-15/16"	22"	13"	13-15/16"	18" base	50 lb	4
CAN-EBMDW-R	Double Can Unit - 35 qt only	White	13-15/16"	22"	13"	13-15/16"	18" base	50 lb	4
CAN-EBMD50B-R	Double Can Unit - 50 qt only	Black	15-3/16"	22-1/16"	12-13/16"	15-3/16"	18" base	50 lb	4
CAN-EBMD50PC-R	Double Can Unit - 50 qt only	Polished Chrome	15-3/16"	22-1/16"	12-13/16"	15-3/16"	18" base	50 lb	4
CAN-EBMD50W-R	Double Can Unit - 50 qt only	White	15-3/16"	22-1/16"	12-13/16"	15-3/16"	18" base	50 lb	4
CAN-DOORKIT	Door Mounting Kit	Black	2-1/2"	5-1/4"	6-5/8"	-	-	-	20
CAN-DOORKITPC	Door Mounting Kit	Polished Chrome	2-1/2"	5-1/4"	6-5/8"	-	-	-	20
CAN-DOORKITW	Door Mounting Kit	White	2-1/2"	5-1/4"	6-5/8"	-	-	-	20

Retail Packaged

Cans available in 2 sizes and 3 standard colors – black, grey & white

Lids available in 3 standard colors plus green for recycling

High-quality polymer material is durable and easy to clean

Compatible with any of our trash can pullouts



	Description	Can Color	Depth	Width	Height	Ctn Qty
CAN-35	35 qt Polymer Can	Black	9-7/16"	14-1/2"	18"	10
CAN-35W	35 qt Polymer Can	White	9-7/16"	14-1/2"	18"	10
CAN-35GRY	35 qt Polymer Can	Grey	9-7/16"	14-1/2"	18"	10
CAN-35LID	Lid for 35 qt Polymer Can	Black	9-3/8"	14-1/2"	1-5/8"	10
CAN-35LIDW	Lid for 35 qt Polymer Can	White	9-3/8"	14-1/2"	1-5/8"	10
CAN-35LIDGRY	Lid for 35 qt Polymer Can	Grey	9-3/8"	14-1/2"	1-5/8"	10
CAN-35LIDG	Lid for 35 qt Polymer Can	Green	9-3/8"	14-1/2"	1-5/8"	10
CAN-50	50 qt Polymer Can	Black	10-1/4"	14-7/8"	22-1/4"	10
CAN-50W	50 qt Polymer Can	White	10-1/4"	14-7/8"	22-1/4"	10
CAN-50GRY	50 qt Polymer Can	Grey	10-1/4"	14-7/8"	22-1/4"	10
CAN-50LID	Lid for 50 qt Polymer Can	Black	10-1/4"	14-5/8"	1-5/8"	10
CAN-50LIDW	Lid for 50 qt Polymer Can	White	10-1/4"	14-5/8"	1-5/8"	10
CAN-50LIDGRY	Lid for 50 qt Polymer Can	Grey	10-1/4"	14-5/8"	1-5/8"	10
CAN-50LIDG	Lid for 50 qt Polymer Can	Green	10-1/4"	14-5/8"	1-5/8"	10



Cleaning Supply Caddy

Organize Your Kitchen in **11 minutes** or less



Retail Packaged



Ergonomic Plastic Handle



- Ergonomic plastic handle
- Removable caddy keeps cleaning supplies organized
- Holds a variety of bottles and boxes
- Mounts easily under your sink, left- or right-handed
- Simply pick it up and take it with you

- Plastic liner tray catches drips
- Full extension ball bearing slides
- Heavy duty wire construction
- 25 lb capacity
- Quickly mounts to cabinet floor using four screws (included)

	Description	Finish	Width	Depth	Height	Min. Opening	Fits Standard Cabinet Size	Weight Capacity	Ctn Qty
SCPO2-R	Cleaning Caddy Pullout	Polished Chrome	11-5/8"	19-11/16"	15-15/16"	11-5/8"	15" - 18" base	25 lb	2

Organize Your Kitchen in
11 minutes
 or less



Pullout Pot & Lid Organizers

Easy Install
 Organizers

Retail Packaged

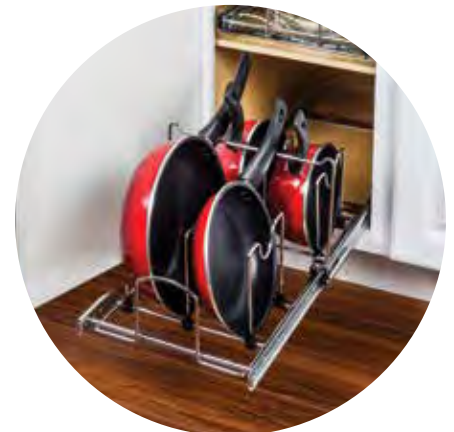
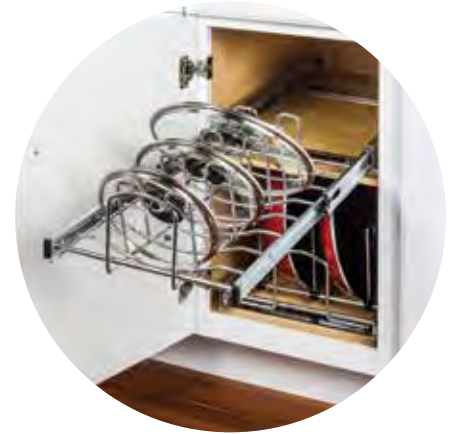

Lid organizer holds 7 lids
 Pot organizer has adjustable dividers
 Pot organizer holds most cookware sizes and brands

Full extension ball bearing slides
 Heavy duty wire construction
 Quickly mounts to cabinet floor or fixed shelf using four screws (included)

	Description	Finish	Width	Depth	Height	Min. Opening	Fits Standard Cabinet Size	Weight Capacity	Ctn Qty
A	MPLO215-R Lid Organizer Pullout	Polished Chrome	11-3/8"	19-11/16"	5-3/8"	11-3/8"	15" - 18" base	100 lb	3
B	MPPO215-R Pots Organizer Pullout	Polished Chrome	11-3/8"	19-11/16"	9"	11-3/8"	15" - 18" base	100 lb	3

Door Mounted Tray System

Organize Your Kitchen in **11 minutes** or less



Retail Packaged



3" deep tray



6" deep tray

Great for pantries or use it as a spice rack
 Mount in lower cabinet for cleaning supplies or trash bag storage
 Holds cans, jars and packets
 Kit includes 2 pcs of track 18" long and 2 trays

Extra trays sold separately
 Use multiple kits for oversize pantry doors
 Heavy duty wire construction
 Quickly mounts to cabinet door using four screws (included)

	Description	Finish	Width	Depth	Height	Min. Opening	Fits Standard Cabinet Size	Weight Capacity	Ctn Qty
A	DMS3-PC-R Door Mount Tray System 3"	Polished Chrome	11-9/16"	3-1/8"	18-1/8"	11-9/16"	15" – 18" base or wall	30 lb	6
B	DMS6-PC-R Door Mount Tray System 6"	Polished Chrome	11-9/16"	5-15/16"	18-1/8"	11-9/16"	15" – 18" base or wall	30 lb	4
C	DMT3-PC-R Individual 3" deep tray	Polished Chrome	11"	3-1/16"	2-7/8"	11"	–	–	20
D	DMT6-PC-R Individual 6" deep tray	Polished Chrome	11"	5-7/8"	3-7/16"	11"	–	–	20

Organize Your Kitchen in
11 minutes
 or less



Single Shelf Lazy Susan

Easy Install
 Organizers

Retail Packaged



- 360 degree revolving tray
- Great for organizing dry goods and cans
- Fits 24" diagonal wall corner cabinet
- Heavy duty wire construction
- Quickly mounts to cabinet floor or fixed shelf using four screws (included)

Description	Finish	Diameter	Height	Fits Standard Cabinet Size	Min. Opening	Weight Capacity	Ctn Qty
MLSR18-S-R Single Shelf Lazy Susan	Polished Chrome	17-5/16"	3-13/16"	24" diagonal wall corner	18"	30 lb	1

3 Tier Spice Rack Pulldown

Organize Your Kitchen in **11 minutes** or less



Retail Packaged



- Great for organizing spices and small jars in your cabinets
- Remove clutter of small, hard to reach items
- Simple pull-down motion gives access to 3 tiers of organization
- Quickly mounts to cabinet floor or fixed shelf using four screws (included)
- Designed for 18" standard wall cabinets



Scan to watch the installation video
<http://delivr.com/2JJWY>



	Description	Finish	Width	Depth	Height	Min. Opening	Fits Standard Cabinet Size	Weight Capacity	Ctn Qty
TTSPD-R	3-Tier Spice Pulldown	Polished Chrome	14-9/16"	10-9/16"	8-5/8"	14-9/16"	18" wall cabinet	20 lb	1

Organize Your Kitchen in
11 minutes
 or less



Over the Door Towel Bar

Easy Install
Organizers

Retail Packaged



Stainless Steel construction

No screws required – simply hang
it over the cabinet door

Fits standard cabinet doors &
drawers (5/8"–3/4" thick)

Perfect for kitchens and bathrooms

	Finish	Width	Depth	Height	Ctn Qty
OTDTHSS-R	Stainless Steel	9-3/4"	2-3/8"	2-13/16"	1

Sink Front Tipout Trays

Organize Your Kitchen in **11 minutes** or less



Retail Packaged



! Shown using 2 hinges. Kit includes 4 hinges for installation on 1 or 2 fronts.

See pages 428-429 for individually packaged hinges and trays

- Convert faux drawer panels to functional storage space
- Kit includes two trays, four self-closing tipout hinges and installation screws
- Tray is easily removable for cleaning
- Slim design for use with large sinks

	Finish	Width	Depth	Height	Ctn Qty
TO11-R	White	11"	2"	3"	4 kits
TOSS11-R	Stainless Steel	11"	2"	3"	4 kits
TO11S-R	White	11"	1-9/16"	3"	4 kits
TOSS11S-R	Stainless Steel	11"	1-9/16"	3"	4 kits
TO14-R	White	14"	2"	3"	4 kits
TOSS14-R	Stainless Steel	14"	2"	3"	4 kits
TO14S-R	White	14"	1-9/16"	3"	4 kits
TOSS14S-R	Stainless Steel	14"	1-9/16"	3"	4 kits

Retail Packaged

Under Cabinet Stemware Rack

- Mounts under the cabinet
- Holds 3 glasses
- Coordinates with Wine Bottle Rack
- Heavy duty wire construction
- Quickly mounts to cabinet with 2 screws (included)

	<i>Finish</i>	<i>Width</i>	<i>Depth</i>	<i>Height</i>	<i>Ctn Qty</i>
STEM1-DBAC-R	Brushed Oil Rubbed Bronze	4-1/16"	9-1/16"	1"	8
STEM1-PC-R	Polished Chrome	4-1/16"	9-1/16"	1"	8
STEM1-SN-R	Satin Nickel	4-1/16"	9-1/16"	1"	8



Under Cabinet Bottle Rack

- Mounts under the cabinet
- Holds 2 bottles
- Coordinates with Stemware Rack
- Heavy duty wire construction
- Quickly mounts to cabinet with 4 screws (included)

	<i>Finish</i>	<i>Width</i>	<i>Depth</i>	<i>Height</i>	<i>Ctn Qty</i>
WBH-DBAC-R	Brushed Oil Rubbed Bronze	3-15/16"	9-5/16"	9-1/16"	3
WBH-PC-R	Polished Chrome	3-15/16"	9-5/16"	9-1/16"	3
WBH-SN-R	Satin Nickel	3-15/16"	9-5/16"	9-1/16"	3





Retail Packaged



U-Shaped Tray Divider

- Organize baking sheets, trays, cutting boards
- Use multiple Tray Dividers to customize storage
- Heavy duty wire construction
- Quickly mounts to cabinet bottom with 4 screws (included)

	Finish	Width	Depth	Height	Ctn Qty
TD-PC-R	Polished Chrome	3-7/16"	11-3/4"	9-15/16"	3



3-Tier Dishcloth Rack

- Mounts to inside of cabinet door
- Holds 3 towels
- Heavy duty wire construction
- Quickly mounts to cabinet door with 2 screws (included)

	Finish	Width	Depth	Height	Min. Opening	Ctn Qty
DTH-PC-R	Polished Chrome	12-3/4"	15/16"	6-1/16"	15"	8

Make closet organization a whole lot easier



Shoe Fences



- Keeps shoes and other items from sliding off closet shelves
- Allows for easy organization of shoes and other items on a shelf
- Available in 17", 23" and 29" lengths
- Heavy duty steel railing available in our most popular finishes: Dark Bronze, Chrome and Satin Nickel
- Easy to install with press-in dowels
- Designed to fit in 5 mm holes on 32 mm spacing



17" Shoe Fence

23" Shoe Fence

29" Shoe Fence

Dimensions	17" W x 1/2" D x 1-3/16" H	23" W x 1/2" D x 1-3/16" H	29" W x 1/2" D x 1-3/16" H
Dark Bronze	SF17-ORB	SF23-ORB	SF29-ORB
Polished Chrome	SF17-PC	SF23-PC	SF29-PC
Satin Nickel	SF17-SN	SF23-SN	SF29-SN
	6 pcs/box 60 pcs/ctn	6 pcs/box 48 pcs/ctn	6 pcs/box 36 pcs/ctn

Pullout Baskets



- 100 lb full extension ball bearing slides included
- Heavy duty wire construction
- Rubber covers on slide hooks keep basket securely in place but allow easy removal of basket
- Closed corners allow smaller items to be stored without falling out
- Available finishes:
Chrome, Dark Bronze and Satin Nickel
- For closets 14" deep or 16" deep



Chrome Basket



Dark Bronze Basket



Satin Nickel Basket

1 mm thick clear plastic material with opaque finish

Fitted to basket bottom for easy drop-in installation

Creates a smooth bottom surface for pantry applications



Plastic Liner

Thick canvas material with velcro closures

Machine washable

Fitted to basket even after washing

Great for delicate clothing in closet applications



Canvas Liner

Pullout Baskets

For 18" wide closets

14" Depth Basket

Dimensions	17" W x 14" D x 6" H	17" W x 14" D x 11" H	17" W x 14" D x 17" H
Chrome Basket	POB1-14176CH	POB1-141711CH	POB1-141717CH
Dark Bronze Basket	POB1-14176ORB	POB1-141711ORB	POB1-141717ORB
Satin Nickel Basket	POB1-14176SN	POB1-141711SN	POB1-141717SN
Canvas Liner	BCL-14176-TAN	BCL-141711-TAN	BCL-141717-TAN*
Plastic Liner	POB1PL-14176	POB1PL-141711	POB1PL-141717*
Recommended screw:	#8 truss head or 7 mm Euro screw	#8 truss head or 7 mm Euro screw	#8 truss head or 7 mm Euro screw
	4 pcs/master	4 pcs/master	4 pcs/master

16" Depth Basket

Dimensions	17" W x 16" D x 6" H	17" W x 16" D x 11" H	17" W x 16" D x 17" H
Weight Capacity	100 lb	100 lb	100 lb
Chrome Basket	POB1-16176CH	POB1-161711CH	POB1-161717CH
Dark Bronze Basket	POB1-16176ORB	POB1-161711ORB	POB1-161717ORB
Satin Nickel Basket	POB1-16176SN	POB1-161711SN	POB1-161717SN
Canvas Liner	BCL-16176-TAN	BCL-161711-TAN	BCL-161717-TAN*
Plastic Liner	POB1PL-16176	POB1PL-161711	POB1PL-161717*
Recommended screw:	#8 truss head or 7 mm Euro screw	#8 truss head or 7 mm Euro screw	#8 truss head or 7 mm Euro screw
	4 pcs/master	4 pcs/master	4 pcs/master

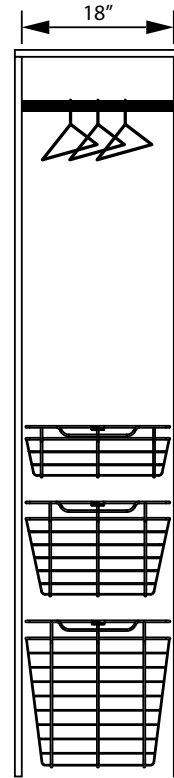

For 24" wide closets

14" Depth Basket

Dimensions	23" W x 14" D x 6" H	23" W x 14" D x 11" H	23" W x 14" D x 17" H
Weight Capacity	100 lb	100 lb	100 lb
Chrome Basket	POB1-14236CH	POB1-142311CH	POB1-142317CH
Dark Bronze Basket	POB1-14236ORB	POB1-142311ORB	POB1-142317ORB
Satin Nickel Basket	POB1-14236SN	POB1-142311SN	POB1-142317SN
Canvas Liner	BCL-14236-TAN	BCL-142311-TAN	BCL-142317-TAN*
Plastic Liner	POB1PL-14236	POB1PL-142311	POB1PL-142317*
Recommended screw:	#8 truss head or 7 mm Euro screw	#8 truss head or 7 mm Euro screw	#8 truss head or 7 mm Euro screw
	4 pcs/master	4 pcs/master	4 pcs/master

16" Depth Basket

Dimensions	23" W x 16" D x 6" H	23" W x 16" D x 11" H	23" W x 16" D x 17" H
Weight Capacity	100 lb	100 lb	100 lb
Chrome Basket	POB1-16236CH	POB1-162311CH	POB1-162317CH
Dark Bronze Basket	POB1-16236ORB	POB1-162311ORB	POB1-162317ORB
Satin Nickel Basket	POB1-16236SN	POB1-162311SN	POB1-162317SN
Canvas Liner	BCL-16236-TAN	BCL-162311-TAN	BCL-162317-TAN*
Plastic Liner	POB1PL-16236	POB1PL-162311	POB1PL-162317*
Recommended screw:	#8 truss head or 7 mm Euro screw	#8 truss head or 7 mm Euro screw	#8 truss head or 7 mm Euro screw
	4 pcs/master	4 pcs/master	4 pcs/master

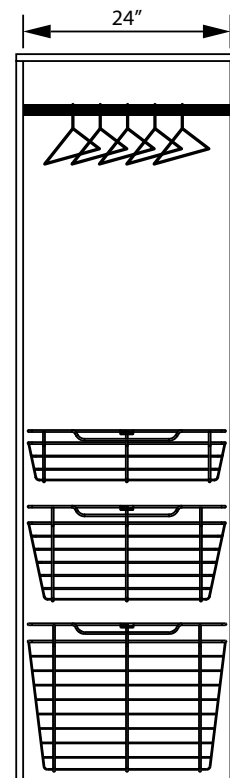

Pullout Baskets

For 30" wide closets

14" Depth Basket

Dimensions	29" W x 14" D x 6" H	29" W x 14" D x 11" H	29" W x 14" D x 17" H
Chrome Basket	POB1-14296CH	POB1-142911CH	POB1-142917CH
Dark Bronze Basket	POB1-14296ORB	POB1-142911ORB	POB1-142917ORB
Satin Nickel Basket	POB1-14296SN	POB1-142911SN	POB1-142917SN
Canvas Liner	BCL-14296-TAN	BCL-142911-TAN	BCL-142917-TAN*
Plastic Liner	POB1PL-14296	POB1PL-142911	POB1PL-142917*
Recommended screw:	#8 truss head or 7 mm Euro screw	#8 truss head or 7 mm Euro screw	#8 truss head or 7 mm Euro screw
	4 pcs/master	4 pcs/master	4 pcs/master

16" Depth Basket

Dimensions	29" W x 16" D x 6" H	29" W x 16" D x 11" H	29" W x 16" D x 17" H
Chrome Basket	POB1-16296CH	POB1-162911CH	POB1-162917CH
Dark Bronze Basket	POB1-16296ORB	POB1-162911ORB	POB1-162917ORB
Satin Nickel Basket	POB1-16296SN	POB1-162911SN	POB1-162917SN
Canvas Liner	BCL-16296-TAN	BCL-162911-TAN	BCL-162917-TAN*
Plastic Liner	POB1PL-16296	POB1PL-162911	POB1PL-162917*
Recommended screw:	#8 truss head or 7 mm Euro screw	#8 truss head or 7 mm Euro screw	#8 truss head or 7 mm Euro screw
	4 pcs/master	4 pcs/master	4 pcs/master

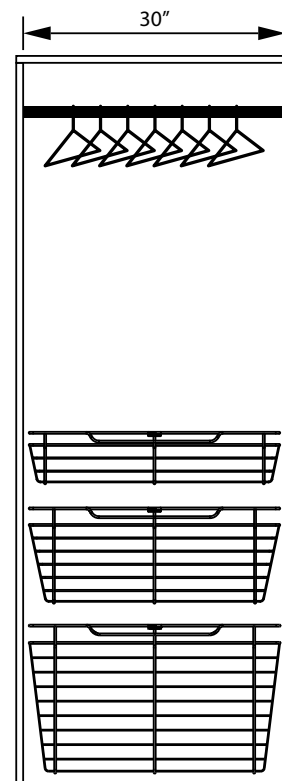

Minimum Opening	
Baskets for 14" Wide Closets	17"
Baskets for 24" Wide Closets	23"
Baskets for 30" Wide Closets	29"

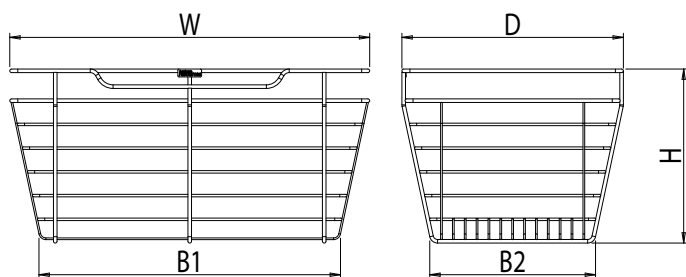

	W	D	H	B1	B2
POB1-141711	17"	14"	11"	13-1/16"	10-1/2"
POB1-161711	17"	16"	11"	13-1/16"	12-1/2"
POB1-142311	23"	14"	11"	19-1/16"	10-1/2"
POB1-162311	23"	16"	11"	19-1/16"	12-1/2"
POB1-142911	29"	14"	11"	25-1/16"	10-1/2"
POB1-162911	29"	16"	11"	25-1/16"	12-1/2"

Slides add additional 1" to width

	W	D	H	B1	B2
POB1-14176	17"	14"	6"	15"	12-3/8"
POB1-16176	17"	16"	6"	15"	14-3/8"
POB1-14236	23"	14"	6"	21"	12-3/8"
POB1-16236	23"	16"	6"	21"	14-3/8"
POB1-14296	29"	14"	6"	27"	12-3/8"
POB1-16296	29"	16"	6"	27"	14-3/8"

Slides add additional 1" to width

	W	D	H	B1	B2
POB1-141717	17"	14"	17"	13"	10-9/16"
POB1-161717	17"	16"	17"	13-3/16"	12-9/16"
POB1-142317	23"	14"	17"	19-1/8"	10-9/16"
POB1-162317	23"	16"	17"	19-3/16"	12-9/16"
POB1-142917	29"	14"	17"	25-1/8"	10-9/16"
POB1-162917	29"	16"	17"	25-3/16"	12-9/16"

Slides add additional 1" to width

Pullout Nylon Hamper



- 100 lb full extension ball bearing slides included
- Heavy duty wire frame construction
- Heavy duty 19" tall black nylon bag featuring ventilated mesh sides and central divider
- Bag is easily removable and includes carry handles
- For closets 14" deep or 18" deep



For 18" wide closets

14" Depth Hamper

Dimensions	17" W x 14" D x 22-1/2" H
Weight Capacity	100 lb
Chrome Frame	POHS-14PC
Dark Bronze Frame	POHS-14ORB
Satin Nickel Frame	POHS-14SN
Replacement bag	POHS14-BAG

Recommended screw: #8 truss head or 7 mm Euro screw

4 pcs/master

For 24" wide closets

18" Depth Hamper

Dimensions	23" W x 18" D x 22-1/2" H
Weight Capacity	100 lb
Chrome Frame	POHS-18PC
Dark Bronze Frame	POHS-18ORB
Satin Nickel Frame	POHS-18SN
Replacement bag	POHS18-BAG

Recommended screw: #8 truss head or 7 mm Euro screw

4 pcs/master

Pullout Plastic Hamper



- Chrome wire pullout with white plastic hamper and lid included
- Designed to fit in a 14" deep, 24" wide closet opening
- Features 100 lb full-extension ball bearing slides
- Mounts to the closet bottom
- Optional door mounting bracket sold separately (item # CAN-DOORKITPC)
- Installs with just 4 screws



For 24" wide closets

Plastic Hamper Pullout

Dimensions 19-3/16" W x 13-3/4" D x 22-11/16" H

Chrome Frame + White Hamper HP-BM1424WPC

Replacement hamper PH-63W

Door Mounting Kit (Chrome) CAN-DOORKITPC

Recommended screw: #8 flat head

1 pc/box

Pullout Pant Rack

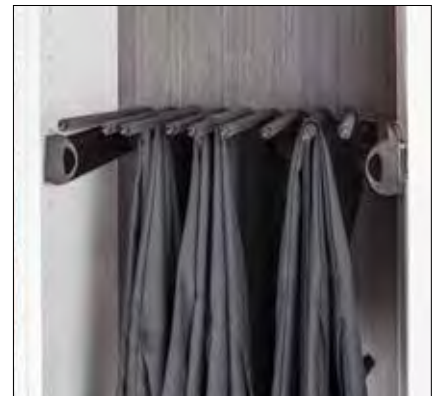

- Features patented* 32 mm Quick-brac™ bracket for easy installation
- Features 100 lb ball bearing slides
- Designed for 14" deep closets
- Available in three widths: 18", 24" and 30" and three finishes: Dark Bronze, Satin Nickel and Polished Chrome
- Width has 3/4" adjustment
- Euro screws provided for 32 mm installation



PATENTED
10,149,540



Scan to watch the installation video

<http://delivr.com/2T73J>

	18" Pant Rack	24" Pant Rack	30" Pant Rack
Dimensions	Adj. 17-3/8"–18-1/8" W 14" D x 3-1/16" H 9 arms	Adj. 23-3/4"–24-1/2" W 14" D x 3-1/16" H 13 arms	Adj. 29-3/4"–30-1/2" W 14" D x 3-1/16" H 16 arms
Weight Capacity	100 lb	100 lb	100 lb
Dark Bronze	PPR-1814-ORB	PPR-2414-ORB	PPR-3014-ORB
Polished Chrome	PPR-1814-PC	PPR-2414-PC	PPR-3014-PC
Satin Nickel	PPR-1814-SN	PPR-2414-SN	PPR-3014-SN
	1 pc/box	1 pc/box	1 pc/box

14" Belt & Tie Racks



Features patented* 32 mm Quick-brac™ bracket for easy installation

Belt rack has 6 double hooks (12 hooks) to hold an array of belt sizes

Tie rack has 18 hooks, perfect for organizing multiple ties or scarves

Features 100 lb push-to-open ball bearing slides

Easily mounts left or right handed

Designed for 14" deep closets

Available in three finishes:

Dark Bronze, Satin Nickel and Polished Chrome

Euro screws provided for 32 mm installation



PATENTED
10,149,540

Mounts left or right handed



14" Belt Rack

14" Tie Rack

Dimensions	13-1/2" W x 1-15/16" D x 2-9/16" H 6 double hooks (12 hooks)	13-1/2" W x 2-7/8" D x 2-9/16" H 18 hooks
Weight Capacity	50 lb	50 lb
Dark Bronze	355B-ORB	355T-ORB
Polished Chrome	355B-PC	355T-PC
Satin Nickel	355B-SN	355T-SN
	1 pc/box	1 pc/box

Tri-Level Tie Organizer

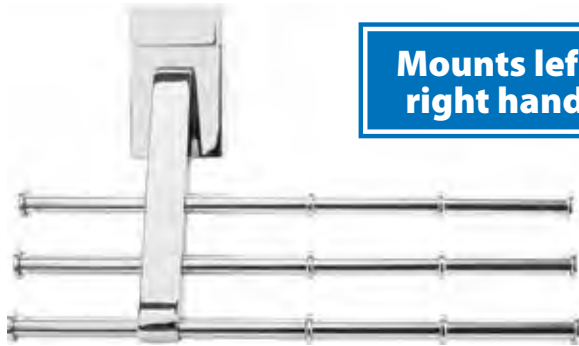

Mounts left or right handed

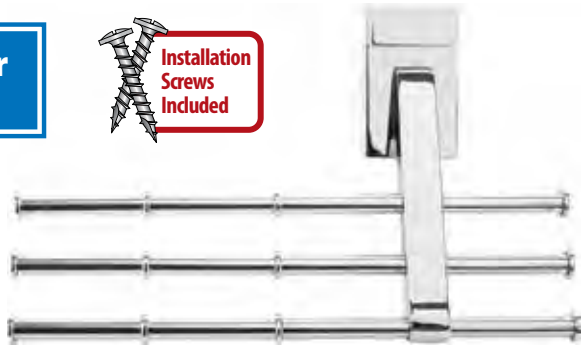

- Holds up to 12 ties or scarves
- Lip on end of each arm prevents items from sliding off
- Arms can be configured for left or right-hand use
- Compact design has small footprint when installed
- Hidden mounting hardware
- Mounts with 2 screws (included)

Tri-Level Tie Organizer

Dimensions	6-3/4" W x 2" D x 4" H
Brushed Oil Rubbed Bronze	356T-DBAC
Polished Chrome	356T-PC
Satin Nickel	356T-SN

4 pcs/box

Cascading Tie Organizer

- Great for ties, scarves and belts
- 12 free-swinging hooks
- Lip on end of each hook prevents items from sliding off
- Non-handed unit can be mounted for left or right-hand use
- Vertical design has small footprint when installed
- Quick and easy mounting with 2 screws



PATENTED
D727,632

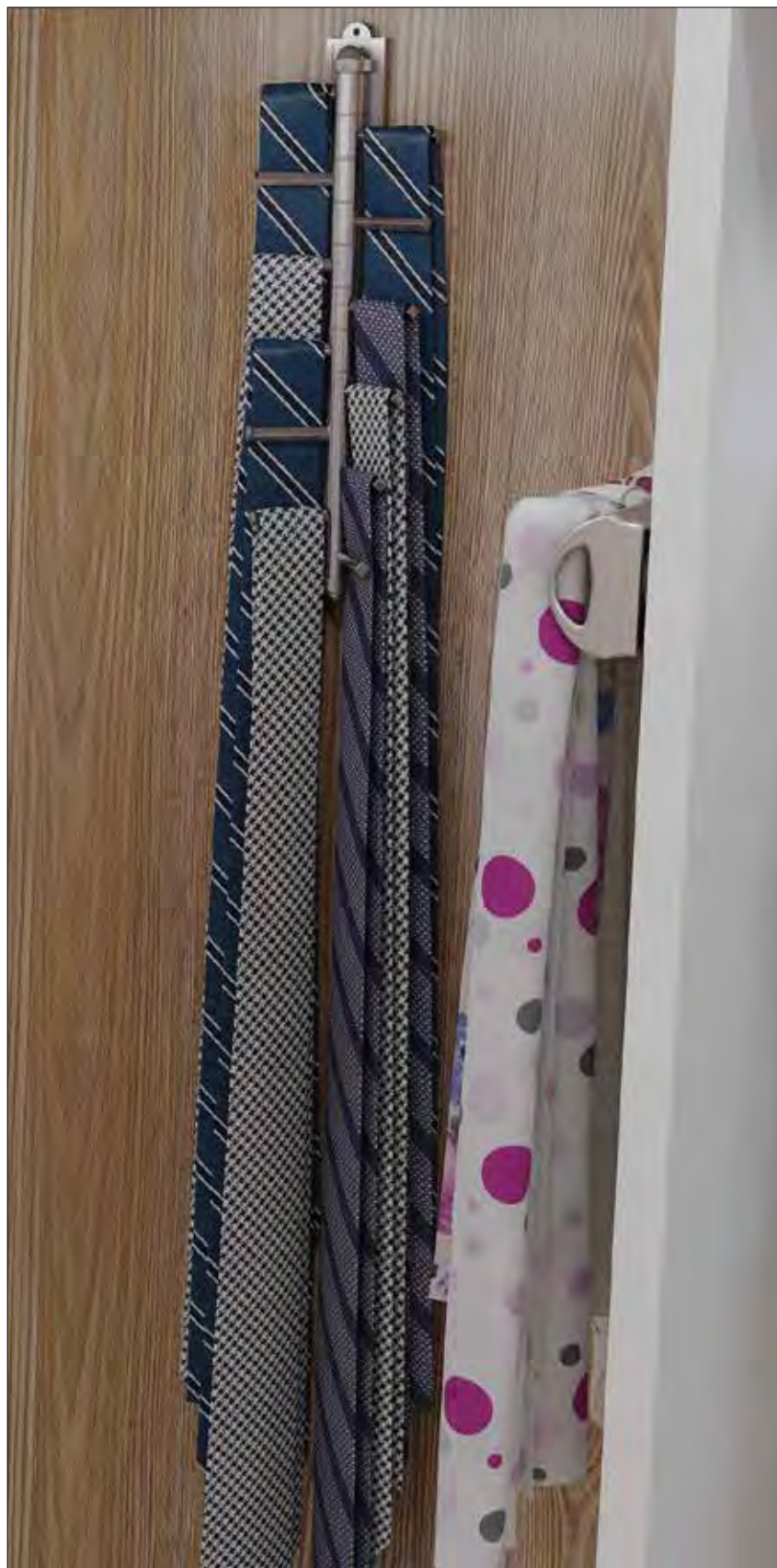

Cascading Tie Organizer

Dimensions 1-1/2" W x 2-7/8" D x 10-1/4" H

Weight Capacity 30 lb

Brushed Oil Rubbed Bronze 357T-DBAC

Polished Chrome 357T-PC

Satin Nickel 357T-SN

4 pcs/box

12" Belt & Tie Racks, Valet Rod



Mounts left or right handed

- Holds up to 12 ties or scarves
- Lip on end of each arm prevents items from sliding off
- Arms can be configured for left or right-hand use
- Compact design has small footprint when installed
- Hidden mounting hardware
- Mounts with 2 screws (included)

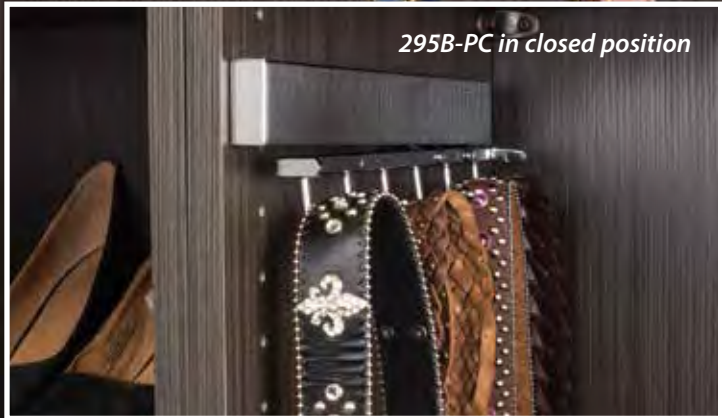

Sliding Belt Rack



Sliding Tie Rack



Sliding Wardrobe/Valet Rod

Dimensions	295mm (11-5/8") Overall Length 6 Belt Hooks, 50mm Spacing	295mm (11-5/8") Overall Length 6 Sets of Pegs to Hold 12 Ties	295mm (11-5/8") Overall Length Built-in Stopper on Ends
Weight Capacity	50 lb	50 lb	50 lb
Brushed Oil Rubbed Bronze	295B-DBAC	295T-DBAC	295W-DBAC
Polished Chrome	295B-PC	295T-PC	295W-PC
	1 pc/box 20 sets/ctn	1 pc/box 20 sets/ctn	1 pc/box 20 sets/ctn

Screw-Mount Racks

Mounts easily with the included wood screws in tight spaces where you may not have the room for a sliding accessory rack

Simple way to organize ties, belts, scarves or necklaces

Each rack is polybagged with attachment screws and UPC labeled

Belt rack has 6 hooks, and tie rack has 6 double hooks

Each hook has a slip resistant clear vinyl cover

Multiple applications including pantries, utility rooms, closets or anywhere that needs an optimized storage solution for hanging items



Screw-Mount Belt Rack



Screw-Mount Tie Rack

Dimensions	11" W x 1-3/4" D x 1-3/4" H 6 Belt Hooks, 50mm Spacing	11" W x 2-1/4" D x 2" H 6 Sets of Pegs to Hold 12 Ties
Weight Capacity	30 lb	30 lb
Brushed Oil Rubbed Bronze	296B-DBAC	296T-DBAC
Polished Chrome	296B-PC	296T-PC

1 pc/polybag
40 sets/ctn

1 pc/polybag
40 sets/ctn

Telescoping Valet Rods



Telescoping valet rods are the perfect accessory for any closet. They allow you to easily organize your clothes for the next day. Fully extended, they add an additional 10" of hanging space. With a 30 lb weight capacity they can easily hold business suits or garment bags. Individually boxed with attachment hardware and installation instructions.

- For clothes hangers and hanging garment bags
- 30 lb weight capacity
- Material: Anodized Aluminum
- Installation hardware and instructions included



355V-PC
Polished Chrome

14" Telescoping Valet Rod

Dimensions	1-1/16" W x 13-11/13" D x 1-13/16" H
Weight Capacity	45 lb
Polished Chrome	355V-PC

1 set/box
12 sets/ctn

Mounts left or right handed



Jewelry Trays



This felt lined jewelry drawer is a perfect way to complete your closet. The jewelry organizer comes in two different configurations: a 5 compartment deep organizer and a 10 compartment shallow organizer with ring insert. Both jewelry drawers are available in black or grey. The jewelry drawer is designed as a complete drawer solution with our 100 lb soft-close slides preinstalled. Works great behind a set of doors or you can mount a drawer front for a more finished look.



- MDF construction, felt lined
- Drawer front can be mounted to front of tray
- Ships fully assembled and ready to install
- 100 lb soft-close slides

	<i>5 Compartment Jewelry Organizer</i>	<i>10 Compartment Jewelry Organizer</i>
Dimensions	23-7/8" W x 14" D x 4" H	23-7/8" W x 14" D x 2" H
Black	JD1-24-BL	JD1-24R-BL
Grey	JD1-24-GR	JD1-24R-GR
Recommended screw:	#8 truss head or 7 mm Euro screw	#8 truss head or 7 mm Euro screw
	1/box 4/ctn	1/box 4/ctn

Wardrobe Lift



Side-mount wardrobe lift with 45 lb weight capacity
 Heavy duty steel construction with plastic housing and handle
 Three sizes available and width adjustable to fit a wide range of openings
 Handle is adjustable for different desired heights
 Instructions, mounting hardware and bumper stops included (some assembly required)

Note: Max handle extension is 41-1/2"



Bumper prevents over-extension of arm

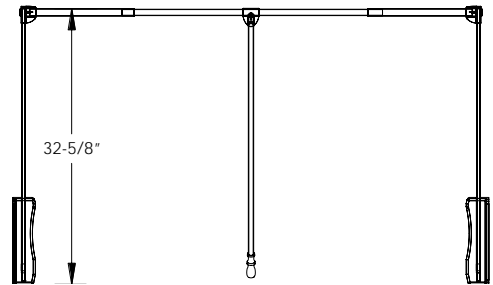

	For 21" – 24" openings	For 25-1/2" – 35" openings	For 33" – 48" openings
Weight Capacity	45 lb	45 lb	45 lb
Chrome with Black Handle & Housing	1521	1523	1532
Black	–	1523-BLK	1532-BLK
	1 set/box 6 sets/ctn	1 set/box 6 sets/ctn	1 set/box 6 sets/ctn

Wardrobe Lift with Soft-close

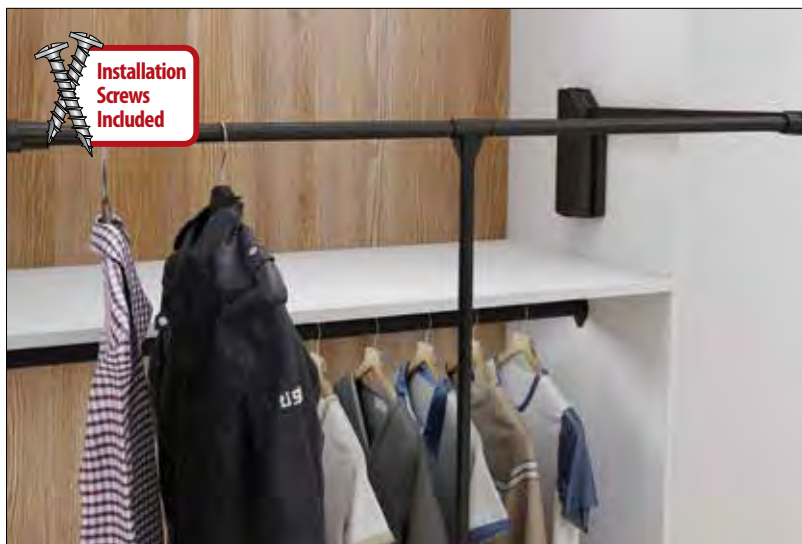

- Integrated soft-close ensures smooth operation up & down
- Side-mount wardrobe lift with 45 lb weight capacity
- Heavy duty steel construction with plastic housing & handle
- Two sizes available and width adjustable to fit a wide range of openings
- Handle is adjustable for different desired heights
- Features mounting brackets to make installation easier and provide a clean finished look
- Instructions and mounting hardware included (some assembly required)

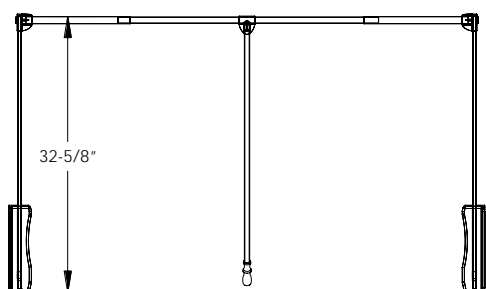

Soft-close bumper for smooth operation

Hidden mounting screws



	For 25-1/2" – 35" openings	For 33" – 48" openings
Weight Capacity	45 lb	45 lb
Chrome with Silver Handle & Housing	1523SC-PC	1532SC-PC
Black	1523SC-BLK	1532SC-BLK
	1 set/box 4 sets/ctn	1 set/box 4 sets/ctn

Laundry Valet

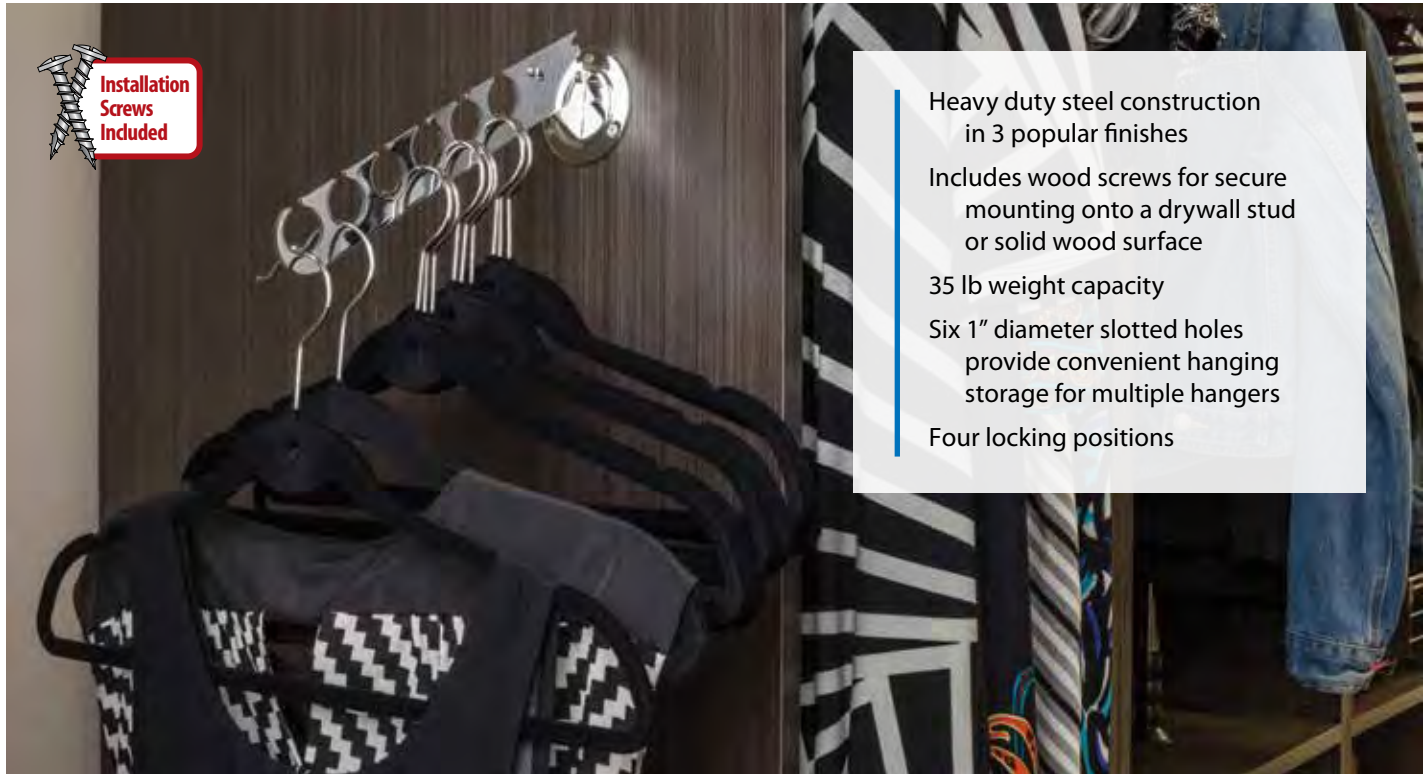

- Heavy duty steel construction in 3 popular finishes
- Includes wood screws for secure mounting onto a drywall stud or solid wood surface
- 35 lb weight capacity
- Six 1" diameter slotted holes provide convenient hanging storage for multiple hangers
- Four locking positions

Our heavy duty laundry valet offers convenient and stylish hanging storage for your garments. The valet features an adjustable design that locks into four different angled positions and folds down when not in use. Its six slotted hole design can hold multiple hangers at a time, and wire neck hangers can easily be moved around. This versatile hanger is great for hanging garments to air dry in a laundry room, to hold coats in a closet or mudroom, or to create additional hanging space in the closet.



276LV-PC in down position

<i>Laundry Valet</i>	
Dimensions	3" W x 10-15/16" D x 3" H
Weight Capacity	35 lb
Brushed Oil Rubbed Bronze	276LV-DBAC
Polished Chrome	276LV-PC
Satin Nickel	276LV-SN

4 pcs/box
32 pcs/ctn

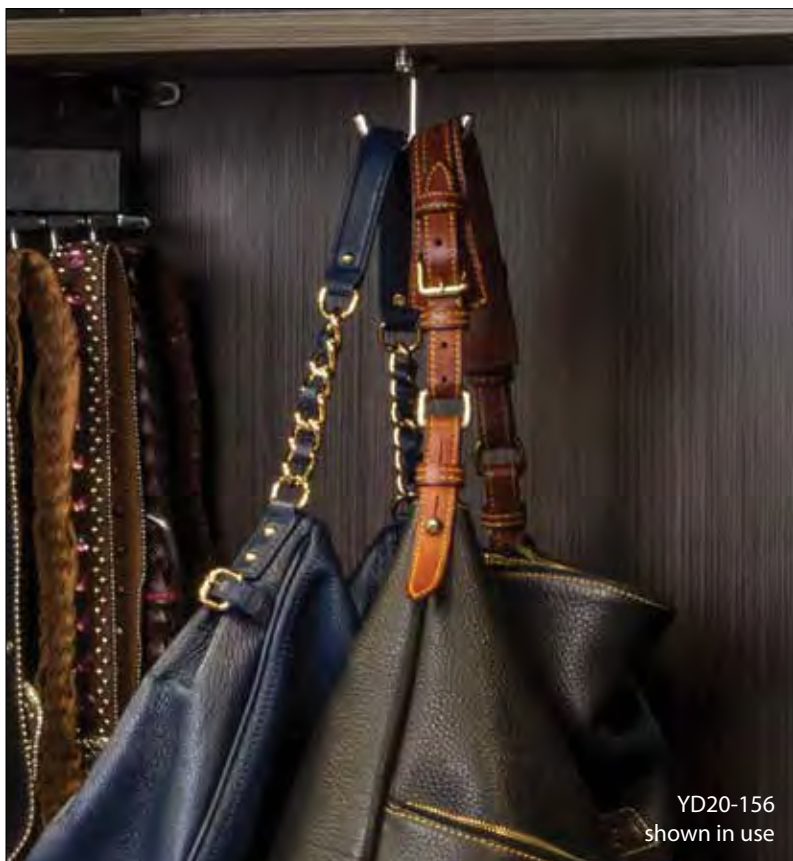

Decorative Hooks

All Hardware Resources hooks are:

- Made to Last – Manufactured from zinc die-cast and weight tested to hold up to 35 lb.
- Same Beautiful Finishes – Available in the same popular finishes as our Jeffrey Alexander and Elements decorative cabinet hardware for a cohesive look throughout the house.
- Lifetime Warranty – Hardware Resources believes in quality, integrity, and reliability by offering a lifetime warranty on all our hooks.

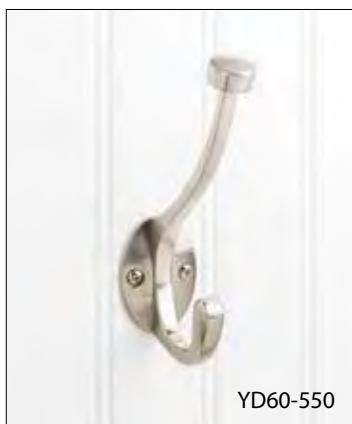

- Brushed Oil Rubbed Bronze (DBAC)
- Satin Nickel (SN)
- Polished Chrome (PC)



- Brushed Oil Rubbed Bronze (DBAC)
- Satin Nickel (SN)
- Polished Chrome (PC)



- Brushed Oil Rubbed Bronze (DBAC)
- Satin Nickel (SN)
- Polished Chrome (PC)

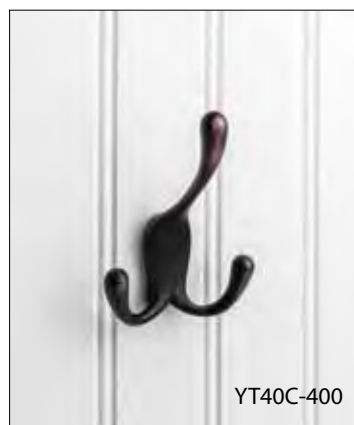

- Brushed Oil Rubbed Bronze (DBAC)
- Satin Nickel (SN)
- Polished Chrome (PC)

Oval Closet Rods

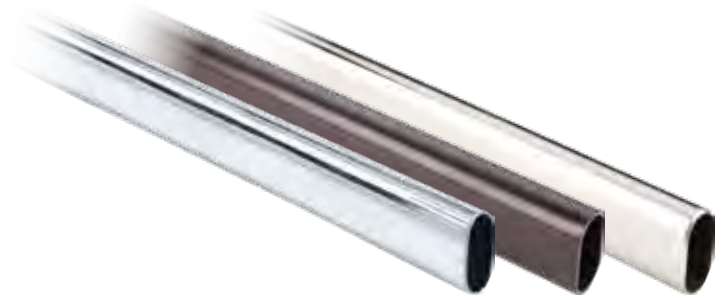
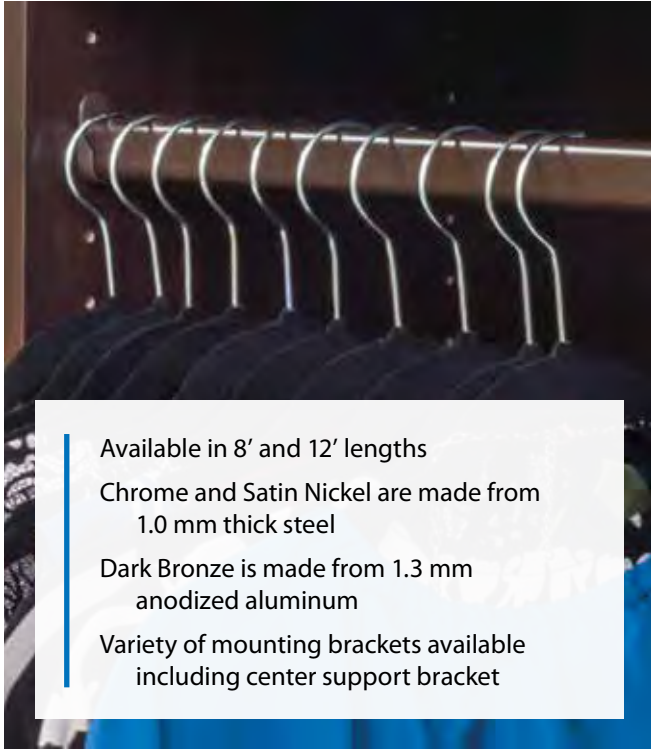

Available in 8' and 12' lengths
 Chrome and Satin Nickel are made from 1.0 mm thick steel
 Dark Bronze is made from 1.3 mm anodized aluminum
 Variety of mounting brackets available including center support bracket

	8' Oval Rod	12' Oval Rod
Dimensions	19/32" x 1-3/16" x 8' CH & SN 1.0 mm Thick ORB 1.3 mm Thick	19/32" x 1-3/16" x 12' CH 1.0 mm Thickness ORB 1.3 mm Thickness
Chrome STEEL	15302CH-2	153012CH-2
Dark Bronze ALUMINUM	15302ORB-2	153012ORB-2
Satin Nickel STEEL	15302SN-2	
	10 pcs/ctn*	10 pcs/ctn*

**NO BROKEN CARTONS. FULL CARTONS ONLY*

Shelf & Rod Support Bracket

Heavy duty 1" wide steel design
 Supports up to 150 lbs per bracket
 Designed for use with Hardware Resources 15 mm x 30 mm Oval Closet Rods.
 8' and 12' rods available in Chrome (steel), Dark Bronze (aluminum) and Satin Nickel (steel)
 10-3/4" overall height x 11-3/4" overall depth (11" interior bracket depth) x 1" wide
 Screws included: 2 pcs #8 x 2" pan head for wall installation and #8 x 5/8" pan head to secure shelf



Dimensions	1" W x 11-3/4" D x 10-3/4" H
Weight Capacity	150 lb
Chrome STEEL	1530CH
Dark Bronze STEEL	1530ORB
Satin Nickel STEEL	1530SN
	2 pc/box 20 pcs/ctn



Support Brackets



Knock-in Mounting Bracket



Screw-in Mounting Bracket



Center Support Bracket

Dimensions	5 mm Diameter Posts 32 mm Center to Center 1 Hole for Extra Screw	22 mm Center to Center Holes	28 mm Center to Center Holes 3" Overall Height
Chrome	M7160	M7175	M7190
Dark Bronze	M7160-ORB	M7175-ORB	M7190-ORB
Satin Nickel	M7160-SN	M7175-SN	M7190-SN
Recommended screw:	#6 flat head (optional)	#6 flat head	#6 flat head
	100 pcs/box 1000 pcs/ctn	100 pcs/box 1000 pcs/ctn	50 pcs/box 500 pcs/ctn

Round Closet Rods

Rods - 1-5/16" Diameter

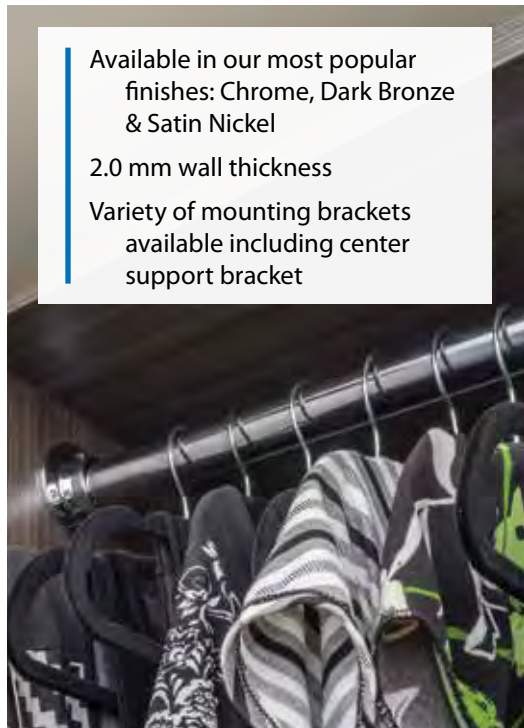

Available in our most popular finishes: Chrome, Dark Bronze & Satin Nickel

2.0 mm wall thickness

Variety of mounting brackets available including center support bracket

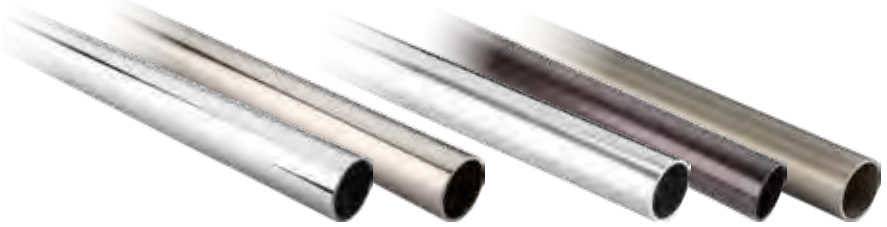

8' Round Rod - Steel

8' Round Rod - Aluminum

Dimensions	1-5/16" Diameter x 8' 2.0 mm Wall Thickness	1-5/16" Diameter x 8' 2.0 mm Wall Thickness
Chrome	151696CH-2	151696CH-A
Dark Bronze		151696ORB-2
Satin Nickel	151696SN-2	151696SN-A

6 pcs/ctn*

6 pcs/ctn*

**NO BROKEN CARTONS. FULL CARTONS ONLY*

Shelf & Rod Support Bracket

Heavy duty 1" wide steel design

Supports up to 150 lbs per bracket

Designed for use with Hardware Resources 1-5/16" Diameter Round Closet Rods.

8' rods available in Chrome (steel), Dark Bronze (aluminum) and Satin Nickel (steel)

10-7/8" overall height x 12-1/2" overall depth (10-3/4" interior bracket depth) x 1" wide

Screws included: 2 pcs #8 x 2" pan head for wall installation and

#8 x 5/8" pan head to secure shelf

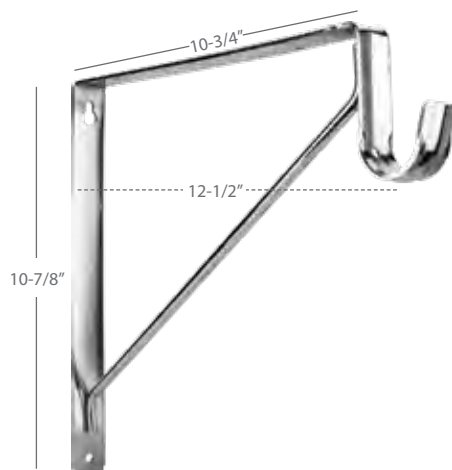

Dimensions	1" W x 12-1/2" D x 10-7/8" H
Weight Capacity	150 lb
Chrome STEEL	1516CH
Dark Bronze STEEL	1516ORB
Satin Nickel STEEL	1516SN
White STEEL	1516WH

2 pc/box
20 pcs/ctn

Round Closet Rods

Support Brackets



M7340-CH



M7345-ORB



Open Knock-in Mounting Bracket



Closed Knock-in Mounting Bracket



Open Screw-in Mounting Bracket



Closed Screw-in Mounting Bracket



Center Support Bracket

Dimensions	5 mm Diameter Posts 32 mm Center to Center 1 Hole for Extra Screw		2-11/16" Overall Width 3 Holes for Screws		2" Center to Center Holes 3" Overall Height
Chrome	M7340-CH	M7345-CH	M7350-CH	M7360-CH	M7370-CH
Dark Bronze	M7340-ORB	M7345-ORB	M7350-ORB	M7360-ORB	M7370-ORB
Satin Nickel	M7340-SN	M7345-SN	M7350-SN	M7360-SN	M7370-SN
Recommended screw:	#6 flat head (optional)	#6 flat head (optional)	screws included	screws included	#6 flat head
	50 pcs/box 200 pcs/ctn	50 pcs/box 200 pcs/ctn	20 pcs/box 200 pcs/ctn	50 pcs/box 200 pcs/ctn	50 pcs/box 200 pcs/ctn

Round Closet Rods

Rods - 1-1/16" Diameter

Woodwork Institute Approved
 Available in 8' and 12' lengths
 2.0 mm wall thickness
 Heavy duty steel
 Variety of mounting brackets available including center support bracket



	8' Round Rod	12' Round Rod
Dimensions	1-1/16" Dia. x 8' 2.0 mm Wall Thickness	1-1/16" Dia. x 12' 2.0 mm Wall Thickness
Chrome STEEL	111696CH-2	111612CH

6 pcs/ctn*

6 pcs/ctn*

*NO BROKEN CARTONS. FULL CARTONS ONLY

Support Brackets



Open Knock-in Mounting Bracket



Open Screw-in Mounting Bracket



Closed Screw-in Mounting Bracket



Center Support Bracket

Dimensions	5 mm Diameter Posts 32 mm Center to Center 1 Hole for Extra Screw	2-11/16" Overall Length 2" Center to Center Holes	28 mm Center to Center Holes 3" Overall Height
Chrome	M7240	M7250	M7260
Recommended screw:	#6 flat head (optional)	screws included	screws included
	250 pcs/ctn	250 pcs/ctn	50 pcs/box 200 pcs/ctn

Round Closet Rods

Rods - 1" Diameter

Anodized aluminum
 1.2 mm wall thickness
 Variety of mounting brackets available including center bracket



8' Round Rod

Dimensions	1" Diameter x 8' 1.2 mm Wall Thickness
Dark Bronze ALUMINUM	100096ORB-2

6 pcs/ctn*

*NO BROKEN CARTONS. FULL CARTONS ONLY

Support Brackets



Open Knock-in Mounting Bracket



Open Screw-in Mounting Bracket



Closed Screw-in Mounting Bracket



Center Support Bracket

Dimensions	5 mm Diameter Posts 32 mm Center to Center 1 Hole for Extra Screw	2-11/16" Overall Length 2" Center to Center Holes	2" Center to Center Holes 3" Overall Height
Dark Bronze	M7240-ORB	M7250-ORB	M7260-ORB
Recommended screw:	#6 flat head (optional)	screws included	screws included
	250 pcs/ctn	250 pcs/ctn	250 pcs/ctn
			50 pcs/box 200 pcs/ctn

LED Lighted Closet Rod

High light output – 400 lumens per foot
Fully assembled LED round closet rod with a rigid LED board for "no dot" effect

Design By: Artistic Cabinetry

APPLICATIONS

- Closet
- Laundry Room
- Stair Railing

FEATURES

- Flange set included with each Lighted Closet Rod
- Compatible with WAV Smart Control
- Each end is field trimmable up to 3"
- High light output at 400 lumens per foot
- 4 watts per foot
- 90 CRI (Color Rendering Index - true color)
- Fully assembled round-shaped rod fixture with frosted, light-diffusing lens for "no dot" effect
- No Ultraviolet (UV) or Infrared (IR)
- 50,000 hour LED life at 70% lumen maintenance
- 12 volt DC plug-in or hardwired power supply required (order separately)
- **Accessories sold separately:** WireWay and Center Bracket Support
- UL Listed

KELVIN TEMPERATURE OPTIONS

- 2700K (27) – Warm White
- 3000K (30) – Soft White
- 4000K (40) – Cool White
- 5000K (50) – Daylight White

LED SPECIFICATIONS

LED Beam Angle – 120°

LED Board – 6" or 12"

NOTE: LED boards are placed in the center of each fixture

INSTALLATION COMPONENTS

See page <?>

POWER SUPPLIES

NOTE: This product requires a 12V DC power supply

See page <?>

WIRE

See page <?>

COMPATIBLE DIMMING SYSTEMS

See page <?>

SENSORS AND SWITCHES

See page <?>

18 in. Satin Nickel fixture shown
LC9R18-4NDSN30

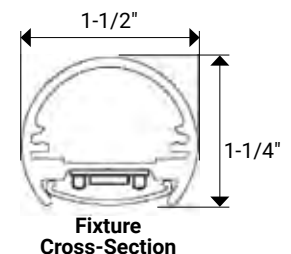
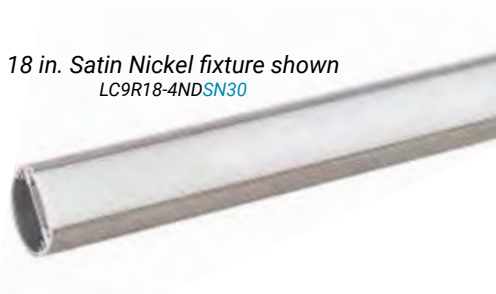

Blue indicates dealer choice. Finish indicates Finish Option. Temp indicates Kelvin Temperature.
LC9R24-6NDBK30 (Example part number for 24" Lighted Closet Rod with a Black Finish in 3000K Kelvin temperature)

4 WATTS PER FOOT

Part Number	Dimensions	Total Watts	Lumens
LC9R18-4NDFinishTemp	18" x 1-1/2" x 1-1/4" (457 mm x 38 mm x 32 mm)	4	400
LC9R24-6NDFinishTemp	24" x 1-1/2" x 1-1/4" (610 mm x 38 mm x 32 mm)	6	600
LC9R30-8NDFinishTemp	30" x 1-1/2" x 1-1/4" (762 mm x 38 mm x 32 mm)	8	800
LC9R36-10NDFinishTemp	36" x 1-1/2" x 1-1/4" (914 mm x 38 mm x 32 mm)	10	1000
LC9R42-12NDFinishTemp	42" x 1-1/2" x 1-1/4" (1067 mm x 38 mm x 32 mm)	12	1200
LC9R48-14NDFinishTemp	48" x 1-1/2" x 1-1/4" (1219 mm x 38 mm x 32 mm)	14	1400
LC9R54-16NDFinishTemp	54" x 1-1/2" x 1-1/4" (1372 mm x 38 mm x 32 mm)	16	1600
LC9R60-18NDFinishTemp	60" x 1-1/2" x 1-1/4" (1524 mm x 38 mm x 32 mm)	18	1800
LC9R66-20NDFinishTemp	66" x 1-1/2" x 1-1/4" (1676 mm x 38 mm x 32 mm)	20	2000
LC9R72-22NDFinishTemp	72" x 1-1/2" x 1-1/4" (1829 mm x 38 mm x 32 mm)	22	2200
LC9R78-24NDFinishTemp	78" x 1-1/2" x 1-1/4" (1981 mm x 38 mm x 32 mm)	24	2400
LC9R84-26NDFinishTemp	84" x 1-1/2" x 1-1/4" (2134 mm x 38 mm x 32 mm)	26	2600
LC9R90-28NDFinishTemp	90" x 1-1/2" x 1-1/4" (2286 mm x 38 mm x 32 mm)	28	2800

FINISH OPTIONS

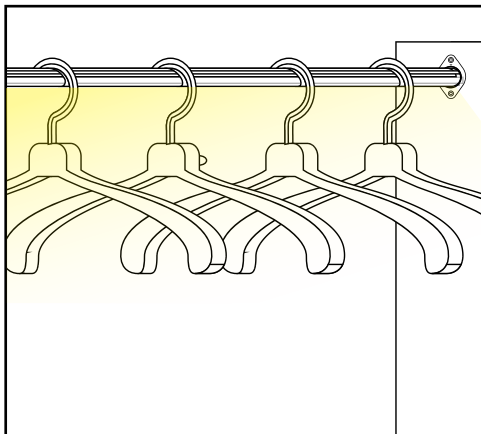
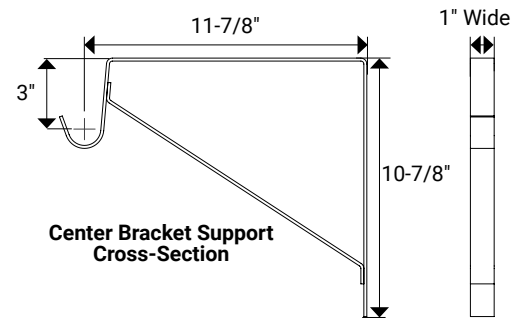
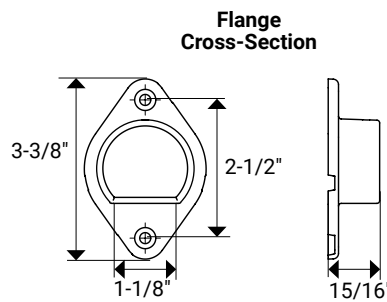
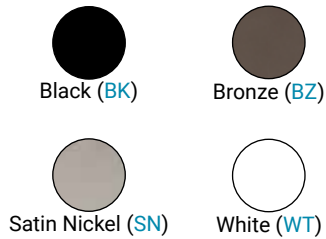

Mount similar to regular closet rod



Lighted Closet Rod Profile

Circular closet rod profile with frosted lens

3 YEAR
WARRANTY



Satin Nickel profile shown
L-0CL-FR-48-SN

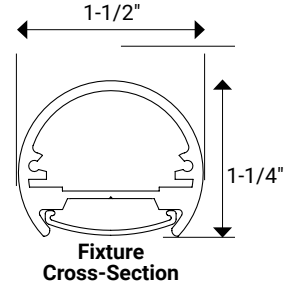
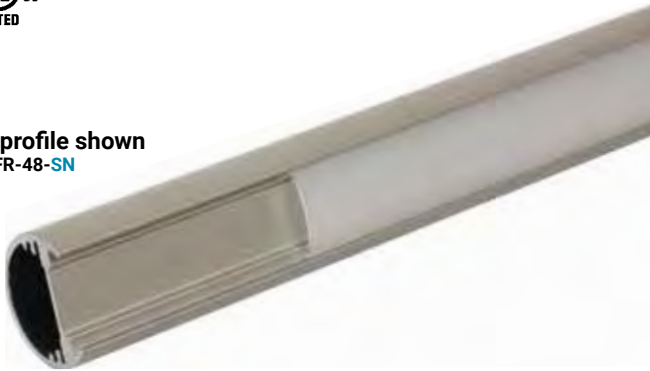

Profile

PART NUMBER	DESCRIPTION	DIMENSIONS	FINISH OPTIONS
L-0LC-FR-48- <i>Finish</i>	48" Lighted Closet Rod Profile with frosted lens.	48" x 1-1/2" x 1-1/4"	Black (BK), Bronze (BZ), Satin Nickel (SN), White (WT)
L-0LC-FR-90- <i>Finish</i>	90" Lighted Closet Rod Profile with frosted lens.	90" x 1-1/2" x 1-1/4"	Black (BK), Bronze (BZ), Satin Nickel (SN), White (WT)

Blue indicates customer choice. Finish indicates fixture finish color.

FINISH OPTIONS



Black (BK)



Bronze (BZ)



Satin Nickel (SN)



White (WT)

OPTIONAL INSTALLATION COMPONENTS

PART NUMBER	DESCRIPTION	DIMENSIONS
LC9R-CBS- <i>Finish</i>	Center Bracket Support (Use every 48") Available in Black (BK), Bronze (BZ), Satin Nickel (SN) or White (WT)	11-7/8" x 1" x 10-7/8"
LC9R-FS-P- <i>Finish</i>	Flange set for Lighted Closet Rod and profile. Available in Black (BK), Bronze (BZ), Satin Nickel (SN) or White (WT)	3-3/8" x 2-1/2" x 1-1/8"
SG9-WW-48 <i>Color</i>	48" field-cuttable WireWay. Available in Black (BK), Grey (GR), or White (WT)	48" x 3/4" x 11/16"

FEATURES

- Circular Closet Rod – 1-1/4"
- Concealed wire management
- Field trimmable
- Simple to install
- 3-year limited warranty
- Profile with frosted, light-diffusing lens
- Accessories sold separately: WireWay, Center Bracket Support, Flange Set
- 12-volt or 24-volt DC plug-in or hardwired power supply required (order separately)

APPLICATIONS

- Closet
- Stair Railing
- Laundry Room

TECHNICAL INFORMATION

Series	Profiles – Lighted Closet Rod
Cuttable	Yes
Rating	UL & cUL Listed
Mounting	Flange Set (sold separately), Screws (included with flange set)
Environment	Dry, Damp, Wet locations
Construction Material	Extruded aluminum, IR Acrylic (lens)
Warranty	3 years

COMPATIBLE 12 VOLT TAPE LIGHTING

PART NUMBER	DESCRIPTION	LUMENS PER FOOT	KELVIN TEMPERATURES
L-T600-16-MW	16 ft. roll of tunable white LED Tape Light featuring two-wire TandemLED technology. Protective IP65 rated micro-waterproof coating.	280 (918/M)	Tunable White Light from 2700K – 5000K
L-RGMW300-16-Temp	(2) 8 ft. rolls of 10 mm wide, higher light output, LED Tape Lighting. Protective IP65 rate micro-waterproof coating.	466 (1527/M)	2700K (27), 3000K (30), 4000K (40), 5000K (50)
L-VMW600-16-Temp	16 ft. roll of 8 mm wide, high light output, LED Tape Light. Protective IP65 rate micro-waterproof coating.	225 (738/M)	2700K (27), 3000K (30), 4000K (40), 5000K (50)
L-VMW600-32-Temp	32 ft. roll of 8 mm wide, high light output, LED Tape Light. Protective IP65 rate micro-waterproof coating.	225 (738/M)	2700K (27), 3000K (30), 4000K (40), 5000K (50)
L-V600-100-Temp	16 ft. roll of 8 mm wide, high light output, LED Tape Light. NON-waterproof rated.	225 (738/M)	2700K (27), 3000K (30), 4000K (40), 5000K (50)
L-RMW300-16-Temp	16 ft. roll of 8 mm wide, medium light output, LED Tape Light. Protective IP65 rate micro-waterproof coating.	120 (395/M)	2700K (27), 3000K (30), 4000K (40), 5000K (50)
L-RMW300-32-Temp	32 ft. roll of 8 mm wide, medium light output, LED Tape Light. Protective IP65 rate micro-waterproof coating.	120 (395/M)	2700K (27), 3000K (30), 4000K (40), 5000K (50)
L-DMW150-16	16 ft. roll of 8 mm wide, multi-color light output, LED Tape Light. Protective IP65 rate micro-waterproof coating.	49 (160/M)	2700K (27), 3000K (30), 4000K (40), 5000K (50)
L-RGB-M300-16	16 ft. roll of 10 mm wide, multi-color light output, LED Tape Light. Protective IP65 rate micro-waterproof coating.	260 (854/M)	Multi-Color Changing
L-RGBM300-32	32 ft. roll of 10 mm wide, medium light output, LED Tape Light. Protective IP65 rate micro-waterproof coating.	260 (854/M)	Multi-Color Changing

COMPATIBLE 24 VOLT TAPE LIGHTING

PART NUMBER	DESCRIPTION	LUMENS PER FOOT	KELVIN TEMPERATURES
L-T24-16-MW	16 ft. roll of tunable white LED Tape Light featuring two-wire TandemLED technology. Protective IP65 rated micro-waterproof coating.	280 (918/M)	Tunable White Light from 2700K – 5000K
L-VMW24-16-Temp	16 ft. roll of 8 mm wide, high light output, LED Tape Light. Protective IP65 rate micro-waterproof coating.	225 (738/M)	2700K (27) 3000K (30) 4000K (40)
L-RMW24-16-Temp	16 ft. roll of 8 mm wide, medium light output, LED Tape Light. Protective IP65 rate micro-waterproof coating.	120 (395/M)	2700K (27) 3000K (30) 4000K (40)

Dovetail Drawer Boxes for Closets

Ordering specifications:

- Standard Drawer, Rollout, or High-Back Rollout Boxes
- Assembled or Unassembled
- Standard Heights with Custom Depth & Width
- 1/4" Standard or 1/2" Bottom
- Optional Universal Notch for Undermount Slides
- Optional Undermount Slide Clip factory installed

Easy Online Ordering & Instant Price Quoting

See website for details

Production and delivery:

- Competitive pricing
- Standard 7 Day Turnaround after order confirmation
- Quick-to-Ship production on qualifying states



- A** 5/8" Hard Maple UV Coated or Unfinished
- B** 5/8" Aspen UV Coated
- C** 5/8" White Birch, Imported, Finger Jointed..... UV Coated
- D** 1/2" Birch Plywood UV Coated or Unfinished
- E** 1/2" Birch Plywood Edgebanded UV Coated
- F** 5/8" Rustic White Birch, Imported, Finger Jointed.. UV Coated
- G** 5/8" Rubberwood, Imported, Finger Jointed UV Coated

HEIGHT OPTIONS	2"	2.5"	3"	3.5"	4"	5"	6"	7"	8"	9"	9.5"	10"	11"	12"
1/2" Birch Plywood	x	x	x	x	x	x	x	x	x	x	x	x	x	x
1/2" Edgebanded Plywood		x	x		x	x	x	x	x	x		x	x	
5/8" Hardwoods	x	x	x	x	x	x	x	x	x	x	x	x	x	x
High-Back (all species)							x	x	x	x	x	x	x	x

*All high-back drawers will have a 3" front and a scoop cutout on the front face. 6" minimum height.

SIZING	Min. Depth	Max Depth	Min. Width (without clips)	Min. Width (with 4 & 6-way clips)	Min. Width (with 2-way clips)	Max Width	Min. Height
Standard Drawer							
5/8" Material	7"	51"	6"	7-1/4"	6-1/4"	51"	2"
1/2" Material	7"	51"	6"	7"	6"	51"	2"
Rollout Drawer							
5/8" Material	7"	51"	6"	7-1/4"	6-1/4"	51"	2"
1/2" Material	7"	51"	6"	7"	6"	51"	2"
High-Back Rollout							
5/8" Material	12"	51"	5-1/2"	7-1/4"	6-1/4"	51"	6"
1/2" Material	12"	51"	5-1/2"	7"	6"	51"	6"

Drawer boxes are manufactured in the USA by Hardware Resources. Hard Maple and Aspen are North American hardwoods. White Birch, Rustic White Birch, and Rubberwood are imported A/B grade hardwood, laminated & finger jointed. Birch plywood is Carb Compliant 9-ply high density plywood with no internal voids. UV cured coating is 100% solid and contains no VOC. Each UV coated piece is double coated to ensure a lasting finish.

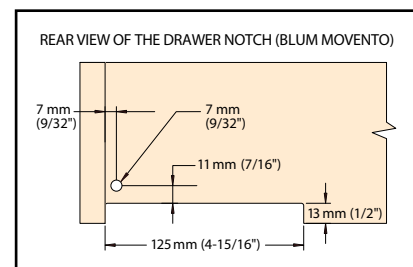
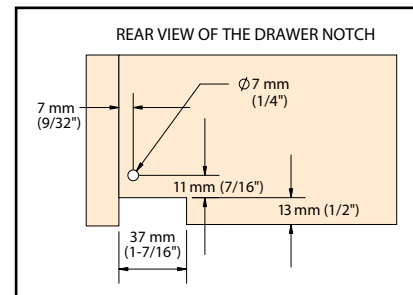



Dovetail Drawer Boxes for Closets

Closet Organizers

Rollouts & High-Back Rollouts

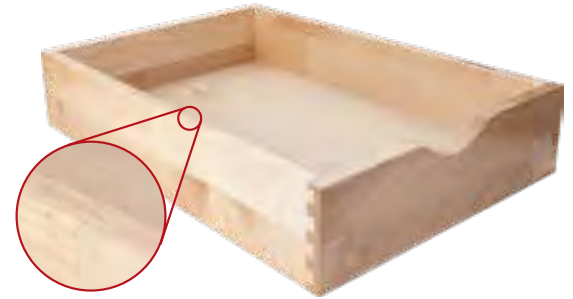

Finger joints may be visible on top edge of box for White Birch



High-Back Rollout (minimum 6" height)

Complimentary High Definition Laser Engraving on Hardwood Boxes

- Upcharge per box for plywood
- Simply provide a high-resolution file of your logo. We'll do the rest!
- Accepted file types are EPS, AI, PDF, PSD, JPEG, TIFF
- Maximum logo size is 1-1/2" tall x 6" long
- Minimum box height for engraving is 3", minimum depth is 8"
- Not available on high-back rollouts or boxes over 24" deep
- Placed on the front left inside edge of the box
- One logo per customer - logos are kept on file for future orders
- *Don't have a logo? Choose from our preselected fonts to customize your company name*



Shelf Supports: Angled

5 mm Pin Diameter

Solid steel construction

3/4" long arm

Available in carton of 1000 pcs



Standard *With 1/8" Hole* *With Brown Sleeve* *With White Sleeve* *With Clear Sleeve* *With Diamond Hole*

Antique Brass	1706AB	1707AB	1708AB			
Antique Copper		1707AC	1708AC			1710AC
Black		1707BLK				
Bright Nickel	1706BN	1707BN	1708BN	1708WBN	1708CBN	1710BN
Polished Brass	1706PB	1707PB				1710PB
	1000 pcs/ctn*	1000 pcs/ctn*	1000 pcs/ctn*	1000 pcs/ctn*	1000 pcs/ctn*	1000 pcs/ctn*

**NO BROKEN CARTONS. FULL CARTONS ONLY*

1/4" Pin Diameter

Solid steel construction

3/4" long arm

Available in carton of 1000 pcs



Standard *With 1/8" Hole* *With Brown Sleeve* *With Brown Sleeve & 7/8" Long Arm*

Antique Brass	1609AB	1610AB		
Antique Copper		1610AC	1611AC	1915AC
Bright Nickel	1609BN	1610BN		
Polished Brass		1610PB		
	1000 pcs/ctn*	1000 pcs/ctn*	1000 pcs/ctn*	1000 pcs/ctn*

**NO BROKEN CARTONS. FULL CARTONS ONLY*

Shelf Supports: Spoon

3 mm Pin Diameter



Spoon

Bright Nickel	1103BN
	1000 pcs/box*
	10,000 pcs/ctn

*NO BROKEN BOXES. FULL BOXES ONLY

Solid steel construction

Available in boxes of 1000 pcs and 10,000 pcs master carton

5 mm Pin Diameter



Spoon



Spoon with Anti-Slide Barb



Grommet 5.5mm drill Ø

Antique Brass	1306AB		1283AB
Antique Copper	1306AC		
Black	1306BLK		1283BLK
Bright Nickel	1306BN	1306BN-2	1283BN
Polished Brass	1306PB		1283PB
	1000 pcs/box*	1000 pcs/box*	1000 pcs/box*
	6000 pcs/ctn	6000 pcs/ctn	5000 pcs/ctn

*NO BROKEN BOXES. FULL BOXES ONLY

Solid steel construction

Anti-slide barb cuts into shelf and prevents shelf movement (1306BN-2)

Supports available in boxes of 1000 pcs and 6000 pcs master carton

Grommets available in boxes of 1000 pcs and 5000 pcs master carton

1/4" Pin Diameter



Spoon



Grommet 7.5mm drill Ø

Antique Brass	1206AB	1284AB
Antique Copper	1206AC	
Black	1206BLK	1284BLK
Bright Nickel	1206BN	1284BN
Polished Brass	1206PB	1284PB
	1000 pcs/box*	1000 pcs/box*
	6000 pcs/ctn	5000 pcs/ctn

*NO BROKEN BOXES. FULL BOXES ONLY

Solid steel construction

Supports available in boxes of 1000 pcs and 6000 pcs master carton

Grommets available in boxes of 1000 pcs and 5000 pcs master carton

Shelf Supports: Pins & Locks

5mm Pins



	16 mm Duplo	24 mm Straight	30 mm Straight	45 mm Straight
Antique Copper				
Bright Nickel		1402BN	418BN	1400BN
Zinc	1401ZN	1402ZN		
	1000 pcs/ctn*	1000 pcs/ctn*	1000 pcs/ctn*	1000 pcs/ctn*

**NO BROKEN CARTONS. FULL CARTONS ONLY*

Solid steel construction
Available in carton of 1000 pcs

Zinc Supports - 5mm Pin



Support with 5 mm Shelf Hold Pin

Zinc	1545ZN
	1000 pcs/box*
	5000 pcs/ctn

**NO BROKEN BOXES. FULL BOXES ONLY*

Solid zinc die cast construction
Available in boxes of 1000 pcs and 5000 pcs master carton

Plastic Supports - 5mm Pin



Support

Almond	1438ALM
	1000 pcs/box*
Brown	1438BRN
	1000 pcs/box*
Clear	1438CL
	100 pcs/box*
White	1438WH
	1000 pcs/box*
	5000 pcs/ctn

**NO BROKEN BOXES. FULL BOXES ONLY*

Synthetic injection molded plastic with steel pin
Available in boxes of 1000 pcs and 5000 pcs master carton

Shelf Supports: Spoon

Plastic Shelf Locks



Highly durable synthetic plastic construction
Available in a variety of pin diameters and shelf thickness combinations

	5 mm Pin 1/2" Shelf	5 mm Pin 5/8" Shelf	5 mm Pin 3/4" Shelf	1/4" Pin 5/8" Shelf	1/4" Pin 3/4" Shelf
Clear	7703CL	7704CL	7705CL	8704CL	8705CL
White	7705WH				
	1750 pcs/box* 3500 pcs/ctn	2000 pcs/box* 4000 pcs/ctn	2500 pcs/box* 5000 pcs/ctn	1750 pcs/box* 3500 pcs/ctn	1750 pcs/box* 3500 pcs/ctn

**NO BROKEN BOXES. FULL BOXES ONLY*

Heavy Duty Plastic Shelf Lock



	5 mm Double Pin 3/4" or 1" Shelf
Clear	7706CL
	2000 pcs/ctn*

**NO BROKEN CARTONS. FULL CARTONS ONLY*

500 lb weight rating per set of 4
Highly durable synthetic plastic construction
Fits 3/4" or 1" shelf thickness
Two pins are 32 mm spaced
ANSI/BHMA A156.9-2003 Grade 1

Shelf Supports: Miscellaneous

Standards & Clips

Single track standards fit in 5/8" wide groove
 Standards quickly install using nails or screws (not included)
 Available in a variety of sizes which can also be cut to length
 Clips snap into place in 3/8" increments for a secure fit and can be easily removed and reattached.



	<i>Standard Clip Builder Pack</i>	<i>Standard Clip Retail Pack</i>	<i>48" Standard</i>	<i>60" Standard</i>	<i>72" Standard</i>
Brass		1460BR-R			
Brown	1460AC	1460AC-R	TRK01-48BRN	TRK01-60BRN	TRK01-72BRN
Nickel/Zinc	1460NI	1460ZN-R	TRK01-48ZN	TRK01-60ZN	TRK01-72ZN
White	1460WH	1460WH-R	TRK01-48WH	TRK01-60WH	TRK01-72WH
	1000 pcs/ctn*	20 pcs/pack 100 pks/ctn	20 pcs/ctn*	20 pcs/ctn*	20 pcs/ctn*

**NO BROKEN CARTONS. FULL CARTONS ONLY*

Heavy Duty Shelf Utility Bracket

Extra heavy duty 1-1/4" wide steel design – supports up to 1200 lbs per pair
 Thick white painted finish is durable and rust resistant
 Supports shelving in a variety of residential and commercial environments: closets, garages, utility rooms, tool sheds and laundry rooms
 Also a perfect support for countertops
 14" overall height x 21-1/4" overall depth
 #10 x 3" pan head screws recommended for wall installation (sold separately)

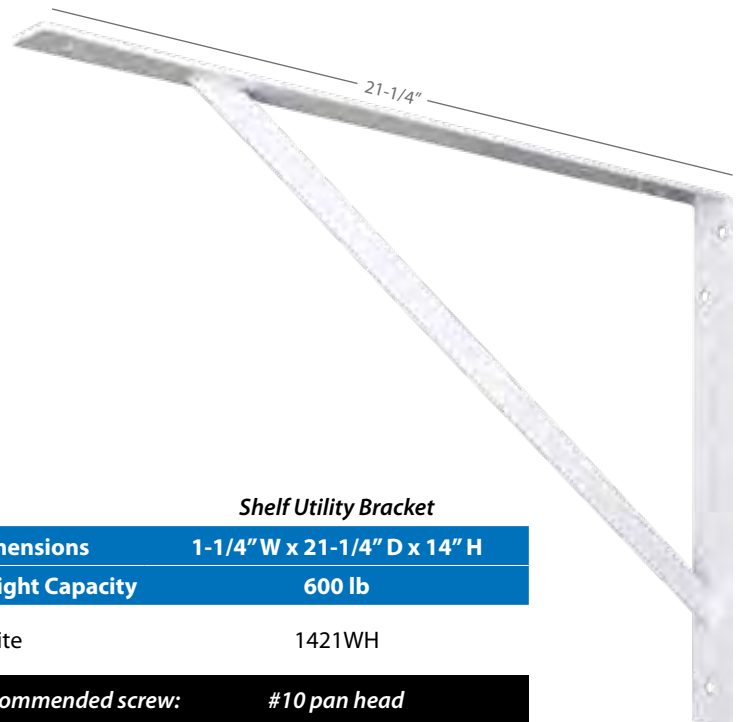

<i>Shelf Utility Bracket</i>	
Dimensions	1-1/4" W x 21-1/4" D x 14" H
Weight Capacity	600 lb
White	1421WH
Recommended screw:	#10 pan head

2 pcs/box
10 pcs/ctn

**NO BROKEN CARTONS. FULL CARTONS ONLY*

Panel Connectors

All measurements shown in mm



Double Connector Cam

Connector Cam

	Brown Plastic	9C19-BRN 250 pcs/ctn	8C19-BRN 250 pcs/ctn
	White Plastic	9C19-WH 250 pcs/ctn	
	Zinc with Nickel Plating	9C19-ZN 250 pcs/ctn	8C19-ZN 250 pcs/ctn

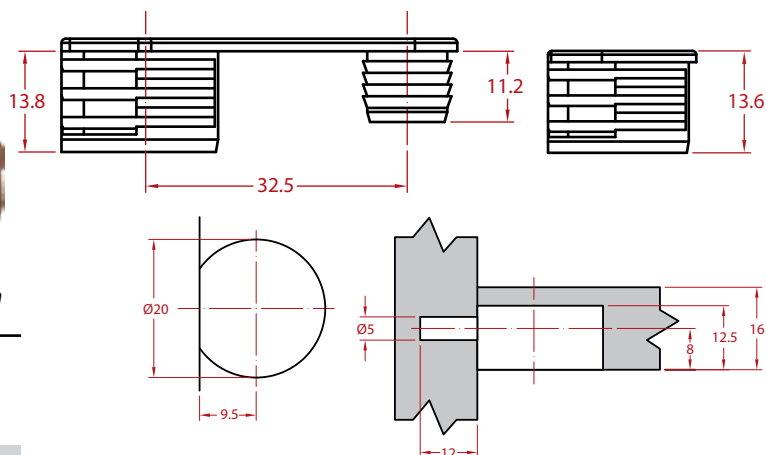

Plastic or zinc housing

Zinc tightening element

For use with 19 mm thickness material

14mm drilling depth



Metal Cam

16 mm material	7C16 250 pcs/ctn
----------------	---------------------

Zinc die cast

Center locking position 9 mm

Drilling depth: 14.0-0.05 mm

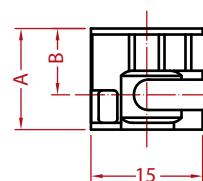

	A	B
7C16	12.2 mm	7.5 mm



Connecting Bolt

36 mm length	5C36 250 pcs/ctn*
--------------	----------------------

*NO BROKEN BOXES.
FULL BOXES ONLY

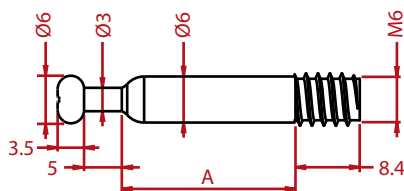

A	
5C36	19 mm



Center Panel Double Bolt

16 mm material	6C16 250 pcs/ctn
19 mm material	6C19 250 pcs/ctn

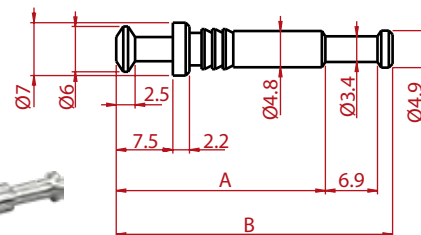

	A	B
6C16	24.7 mm	33.6 mm
6C19	27.7 mm	36.6 mm

You Buy. You Try. You Decide.

Place a Trial Order any new-to-you cabinet organizer products and try them out. If you're not satisfied we'll take them back. Guaranteed!

How the Trial Order program works

1. Place a Trial Order for any cabinet organizers. Trial Orders can be combined with a regular order. We pay the freight on Trial Orders.
2. Test the products risk-free.
3. If you're not completely satisfied, call us. We'll give you immediate full credit on the Trial Order purchase. We'll arrange for the products to be picked up later – no need to save the original packaging, ship them back, etc. We make it easy. We would appreciate hearing your observations on the products.



How to order

1. Place an order with your local sales rep or call **800-463-0660**
2. Use code **TRIAL-CABINETORG** for the Trial Order products



Hardware Resources believes in quality, integrity, and reliability. We uphold the highest standards of service and responsibility in the industry.

As such, Hardware Resources warrants all cabinet and closet organizers against defects in material and workmanship as long as the original consumer purchaser owns the products, if the original consumer purchased the products from an authorized distributor of Hardware Resources. Hardware Resources cannot guarantee the quality or condition of products from distributors who do not agree to meet our high standards, and therefore, no warranty is provided for products from unauthorized sellers.

If the finish of any of these items tarnishes, corrodes, rusts, begins to chip or rub off or has any other defect, Hardware Resources will send to the original purchaser, a new replacement product of the same or comparable style and quality at no charge. If a replacement is no longer available, Hardware Resources will refund to the original purchaser, the current wholesale value of the item.

This warranty is a warranty of replacement only. Hardware Resources specifically does not warrant removal of the product nor installation of replacement new product. This warranty does not apply when the item has been tampered with, misused, improperly installed, altered from the original form, or damaged through improper cleaning, abuse or accident.

In the unlikely event that a defective cabinet or closet organizer is encountered, please contact Customer Service at 800.463.0660. Please be able to provide a brief description and photographs of the defect.