



CANMADE

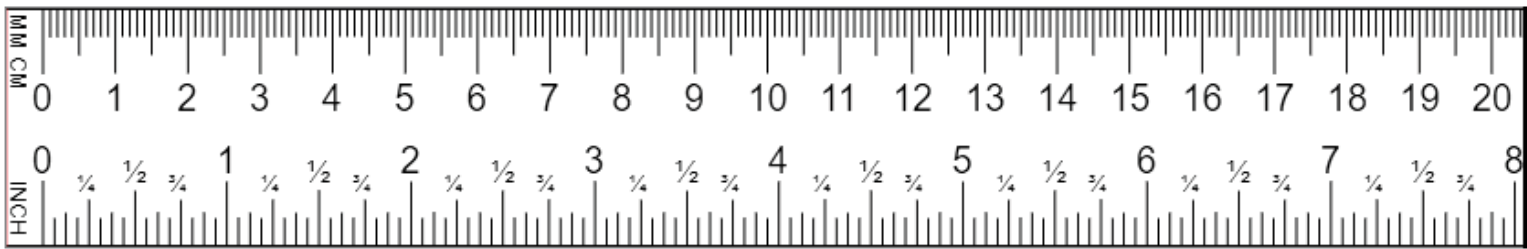

TABLE OF CONTENTS

OUR BRANDS	1
DECORATIVE HARDWARE	
Cemux Handles	2
Canmade Selection	10
Top Knobs, Atlas, Jeffrey Alexander, and Elements	22
FUNCTIONAL HARDWARE	
Hinges	26
Slides	31
Press Machine	41
Slides Systems	42
ORGANIZATION AND OPTIMIZATION	
Bathroom Organizers	43
Cabinet Organizers	44
Waste and Recycling	53
Closet and Laundry Accessories	57
Jewelry Trays	62
Closet Pull Outs	63
Wall Beds	64
WOOD PRODUCTS	
Dovetails	65
Borma Wachs	65
DOORS, DRAWERS AND PANELS	
MDF Crown & Thermofoil Doors	66
MDF Doors	71
Aluminum & Polyester Doors	73
Glass Doors	75
Wood Doors	77
EDGBANDING, COVERS AND REPAIRS	
Wire Mesh & Edgebanding	78
Melamine and Veneer Edgebanding	80
Fillers and Crayons	81
LIGHTING AND ELECTRICAL PRODUCTS	
Lighting and Electronics	82
Lighting Strips	89
ACCESSORIES AND FASTENERS	
Miscellaneous	90
Locks, File Holders, and Grommets	92
Shelf Supplies	97
Bits and Screws	99
KITCHEN SINKS AND STOVETOPS	99
GARAGE AND OUTDOOR LIVING	101
ADHESIVES	
General Adhesives	102
SANDPAPER AND TAPE	105
CABINET MASTER	105
NOTES	108
POLICIES AND PROCEDURES	109

MILLIMETERS AND INCHES

	FRACTIONS									
	0	1/16	1/8	1/4	3/8	1/2	5/8	3/4	7/8	15/16
0	0	1.6	3.2	6.4	9.5	12.7	16	19	22	23.8
1	25.4	27	29	32	35	38	41	44	48	49
2	51	52	54	57	60	64	67	70	73	75
3	76	78	79	83	86	89	92	96	98	100
4	102	103	105	108	111	114	117	121	124	125
5	128	129	130	133	137	140	143	146	149	151
6	152	154	156	159	162	165	168	171	175	176
7	178	179	181	184	187	191	194	197	200	202
8	203	205	206	210	213	216	219	222	225	227
9	229	230	232	235	238	241	244	248	251	252
10	254	256	257	260	264	267	270	273	276	278
11	279	281	283	286	289	292	295	298	302	303
12	305	306	308	311	314	318	321	324	327	329
13	330	332	333	337	340	343	346	349	352	354
14	356	357	359	362	365	368	371	375	378	379
15	381	383	384	387	391	394	397	400	403	405
16	406	408	410	413	416	419	422	425	429	430
17	432	433	435	438	441	445	448	451	454	456
18	457	459	460	464	467	470	473	476	479	481
19	483	484	486	489	492	495	498	502	505	506
20	508	510	511	514	518	521	524	527	530	532
21	533	535	537	540	543	546	549	552	556	557
22	559	560	562	565	568	572	575	578	581	583
23	584	586	587	591	594	597	600	603	606	608
24	610	611	613	616	619	622	625	629	632	633
25	635	637	638	641	645	648	651	654	657	659
26	660	662	664	667	670	673	676	679	683	684
27	686	687	689	692	695	699	702	705	708	710
28	711	713	714	718	721	724	727	730	733	735
29	737	738	740	743	746	749	752	756	759	760
30	762	764	765	768	772	775	778	781	784	786



This chart is to give an understanding of converting the sizes between Inches and Millimeters. You can use this chart when working with our Handles, Hinges and Slides.

OUR BRANDS

hardware
resources[®]

JEFFREY ALEXANDER[®]
by Hardware Resources

Tulip Cooking[®]

ELEMENTS[®]

CyCan Industries
quality under pressure

atlas
HOMEWARES

TASK
lighting

TK | TOP
KNOBS

CEMUX
LIVE YOUR LIFE

STARAXE[®]

SOUDAL

A+

ILCA
— SINCE 1977 —

MTH

 BELWITH
KEELER[®]

SUGATSUNE

KV
KNAPE & VOGT

LEPAGE
Building Confidence[™]

 **UNEEDA**

BARAZIN

PS[®]

Akfix[®]

 **Tensor**
Adhesives That Outperform

Jowat 
Adhesives

 **ROBERTSON SCRULOX**
SCREWS[®]

HERMES

 **BORMA WACHS**[®]
Wood Professional Cosmetics
& Eco-Finishes

 **REGINOX** 

OLON 

RGX | KITCHEN
PRODUCTS



PRODUCT NUMBER	SIZE (Centre to Centre)	FINISH
H-6033-96BG	96mm	Brushed Gold
H-6033-96BSN		Brushed Satin Nickel
H-6033-96MB		Matt Black
H-6033-96PC		Polished Chrome
H-6033-128BG	128mm	Brushed Gold
H-6033-128BSN		Brushed Satin Nickel
H-6033-128MB		Matt Black
H-6033-128PC		Polished Chrome
H-6033-160BG	160mm	Brushed Gold
H-6033-160BSN		Brushed Satin Nickel
H-6033-160MB		Matt Black
H-6033-160PC		Polished Chrome
H-6033-192BG	192mm	Brushed Gold
H-6033-192BSN		Brushed Satin Nickel
H-6033-192MB		Matt Black
H-6033-192PC		Polished Chrome
H-6033-256BG	256mm	Brushed Gold
H-6033-256BSN		Brushed Satin Nickel
H-6033-256MB		Matt Black
H-6033-256PC		Polished Chrome
H-6033-320BG	320mm	Brushed Gold
H-6033-320BSN		Brushed Satin Nickel
H-6033-320MB		Matt Black
H-6033-320PC		Polished Chrome





MONTREAL

PRODUCT NUMBER	SIZE (Centre to Centre)	FINISH
H-8061-96BG	96mm	Brushed Gold
H-8061-96BSN		Brushed Satin Nickel
H-8061-96MB		Matt Black
H-8061-96PC		Polished Chrome
H-8061-128BG	128mm	Brushed Gold
H-8061-128BSN		Brushed Satin Nickel
H-8061-128MB		Matt Black
H-8061-128PC		Polished Chrome
H-8061-160BG	160mm	Brushed Gold
H-8061-160BSN		Brushed Satin Nickel
H-8061-160MB		Matt Black
H-8061-160PC		Polished Chrome
H-8061-192BG	192mm	Brushed Gold
H-8061-192BSN		Brushed Satin Nickel
H-8061-192MB		Matt Black
H-8061-192PC		Polished Chrome
H-8061-256BG	256mm	Brushed Gold
H-8061-256BSN		Brushed Satin Nickel
H-8061-256MB		Matt Black
H-8061-256PC		Polished Chrome
H-8061-320BG	356mm	Brushed Gold
H-8061-320BSN		Brushed Satin Nickel
H-8061-320MB		Matt Black
H-8061-320PC		Polished Chrome





MIAMI



PRODUCT NUMBER	SIZE (Centre to Centre)	FINISH
H-4001-96BG	96mm	Brushed Gold
H-4001-96BSN		Brushed Satin Nickel
H-4001-96MB		Matt Black
H-4001-96PC		Polished Chrome
H-4001-128BG	128mm	Brushed Gold
H-4001-128BSN		Brushed Satin Nickel
H-4001-128MB		Matt Black
H-4001-128PC		Polished Chrome
H-4001-160BG	160mm	Brushed Gold
H-4001-160BSN		Brushed Satin Nickel
H-4001-160MB		Matt Black
H-4001-160PC		Polished Chrome
H-4001-192BG	192mm	Brushed Gold
H-4001-192BSN		Brushed Satin Nickel
H-4001-192MB		Matt Black
H-4001-192PC		Polished Chrome
H-4001-256BG	256mm	Brushed Gold
H-4001-256BSN		Brushed Satin Nickel
H-4001-256MB		Matt Black
H-4001-256PC		Polished Chrome
H-4001-320BG	356mm	Brushed Gold
H-4001-320BSN		Brushed Satin Nickel
H-4001-320MB		Matt Black
H-4001-320PC		Polished Chrome



LAS VEGAS

PRODUCT NUMBER	SIZE (Centre to Centre)	FINISH
H-0454-128BG	128mm	Brushed Gold
H-0454-128BSN		Brushed Satin Nickel
H-0454-128MB		Matt Black
H-0454-128PC		Polished Chrome
H-0454-160BG	160mm	Brushed Gold
H-0454-160BSN		Brushed Satin Nickel
H-0454-160MB		Matt Black
H-0454-160PC		Polished Chrome
H-0454-320BG	320mm	Brushed Gold
H-0454-320BSN		Brushed Satin Nickel
H-0454-320MB		Matt Black
H-0454-320PC		Polished Chrome





LOS ANGELES



PRODUCT NUMBER	SIZE (Centre to Centre)	FINISH
H-8055-96BG	96mm	Brushed Gold
H-8055-96BSN		Brushed Satin Nickel
H-8055-96MB		Matt Black
H-8055-96PC		Polished Chrome
H-8055-128BG	128mm	Brushed Gold
H-8055-128BSN		Brushed Satin Nickel
H-8055-128MB		Matt Black
H-8055-128PC		Polished Chrome
H-8055-160BG	160mm	Brushed Gold
H-8055-160BSN		Brushed Satin Nickel
H-8055-160MB		Matt Black
H-8055-160PC		Polished Chrome
H-8055-192BG	192mm	Brushed Gold
H-8055-192BSN		Brushed Satin Nickel
H-8055-192MB		Matt Black



CHICAGO

PRODUCT NUMBER	SIZE (Centre to Centre)	FINISH
H-2008-96BG	96mm	Brushed Gold
H-2008-96BSN		Brushed Satin Nickel
H-2008-96MB		Matt Black
H-2008-96PC		Polished Chrome
H-2008-128BG	128mm	Brushed Gold
H-2008-128BSN		Brushed Satin Nickel
H-2008-128MB		Matt Black
H-2008-128PC		Polished Chrome
H-2008-160BG	160mm	Brushed Gold
H-2008-160BSN		Brushed Satin Nickel
H-2008-160MB		Matt Black
H-2008-160PC		Polished Chrome
H-2008-192BG	192mm	Brushed Gold
H-2008-192BSN		Brushed Satin Nickel
H-2008-192MB		Matt Black
H-2008-192PC		Polished Chrome
H-2008-256BG	256mm	Brushed Gold
H-2008-256BSN		Brushed Satin Nickel
H-2008-256MB		Matt Black
H-2008-256PC		Polished Chrome
H-2008-320BG	320mm	Brushed Gold
H-2008-320BSN		Brushed Satin Nickel
H-2008-320MB		Matt Black
H-2008-320PC		Polished Chrome





NEW YORK



PRODUCT NUMBER	SIZE (Centre to Centre)	FINISH
H-8053-128BG	128mm	Brushed Gold
H-8053-128BSN		Brushed Satin Nickel
H-8053-128MB		Matt Black
H-8053-128PC		Polished Chrome
H-8053-160BG	160mm	Brushed Gold
H-8053-160BSN		Brushed Satin Nickel
H-8053-160MB		Matt Black
H-8053-160PC		Polished Chrome
H-8053-192BG	192mm	Brushed Gold
H-8053-192BSN		Brushed Satin Nickel
H-8053-192MB		Matt Black
H-8053-192PC		Polished Chrome
H-8053-256BG	256mm	Brushed Gold
H-8053-256BSN		Brushed Satin Nickel
H-8053-256MB		Matt Black
H-8053-256PC		Polished Chrome
H-8053-320BG	320mm	Brushed Gold
H-8053-320BSN		Brushed Satin Nickel
H-8053-320MB		Matt Black
H-8053-320PC		Polished Chrome



CRYSTAL KNOBS

PRODUCT NUMBER	SIZE	FINISH
K-1560-30MB	30mm CC x 42mm	Matt Black
K-1560-30BSN		Brushed Satin Nickel
K-1560-30PC		Polished Chrome

HMA194-84C
160mmCC



HMA194-84B
128mmCC

HMA194-84A
96mmCC

HMA194-25C
160mmCC



HMA194-25B
128mmCC

HMA194-25A
96mmCC



KM9225-84A
32mm x 23mmH



KM9225-50B
32mm x 23mmH

HM6416-50D
160mmCC



KM6404-50A
39mm x 28mmH

HM6416-25D
160mmCC



KM6404-25A
39mm x 28mmH



KM9225-25A
32mm x 23mmH



KM0992-95A
34mm x 28mmH

HM4075-50B
152mmCC



HM4076-25B
152mmCC



KM4081-50B
34mm x 27mm
28mmH



KM4081-25A
34mm x 27mm
28mmH



HM4526-17G
256mmCC

HM4526-25G
256mmCC

HM4526-17D
160mmCC

HM4526-25D
160mmCC

HM4526-17C
128mmCC

HM4526-25C
128mmCC

HM6180-95C
128mmCC

KM0508-25B
20mm x 30mmH

KM0040-25B
22mm x 24mmH

KMB100-25B
29mm x 24mmH

KM0500-95A
32mm x 31mmH

HMH341-25E
192mmCC

HMH341-25D
160mmCC

HMH341-25C
128mmCC

HM3534-25B
96mmCC

HM3076-25B
128mmCC

HM2592-02B
96mmCC

2981SN
76mmCC



HM0839-17B
96mmCC

HM0839-25B
96mmCC (Dull Nickel)

HM0839-25A
96mmCC (Satin Nickel)



HM8461-25B
128mmCC

HM270A-25A
96mmCC



HM7150-25B
96mmCC

HM7150-50A
96mmCC

KM9227-50A
32mm x 30mmH



HM0692-25B
128mmCC

HM0692-09B
128mmCC



HM0840-17B
96mmCC



KM1953-25B
37mm x 20mm x 23mmH



HM1372-17B
96mmCC



HM0840-17D
96mmCC



KM0385-17A
30mm x 28mmH



HM3045-17D
96mmCC



HM0840-95B
96mmCC



KM0385-95A
30mm x 28mmH



HM3045-25B
96mmCC



HM0840-09B
96mmCC

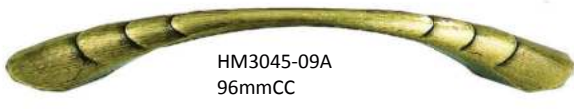

HM3045-09A
96mmCC



HM0840-95C
128mmCC



KM0385-09B
30mm x 28mmH



HM3138-25B
96mmCC



KM2083-17A
32mm x 31mmH



KM2083-08A
32mm x 31mmH



KM2083-09B
32mm x 31mmH



HM3138-09A
96mmCC



CODE	⊙ C.C ⊙	LONGUEUR LENGTH	LARGEUR WIDTH	HAUTEUR HEIGHT	FINI FINISH	VIS SCREW
H-1146-02A	96mm	133mm	12mm	32mm	Noir / Black	8/32
H-1146-02C	128mm	168mm	12mm	32mm	Noir / Black	8/32
H-1146-02D	160mm	200mm	12mm	32mm	Noir / Black	8/32
H-1146-02E	192mm	232mm	12mm	32mm	Noir / Black	8/32
H-1146-02F	224mm	264mm	12mm	32mm	Noir / Black	8/32

BAR HANDLES

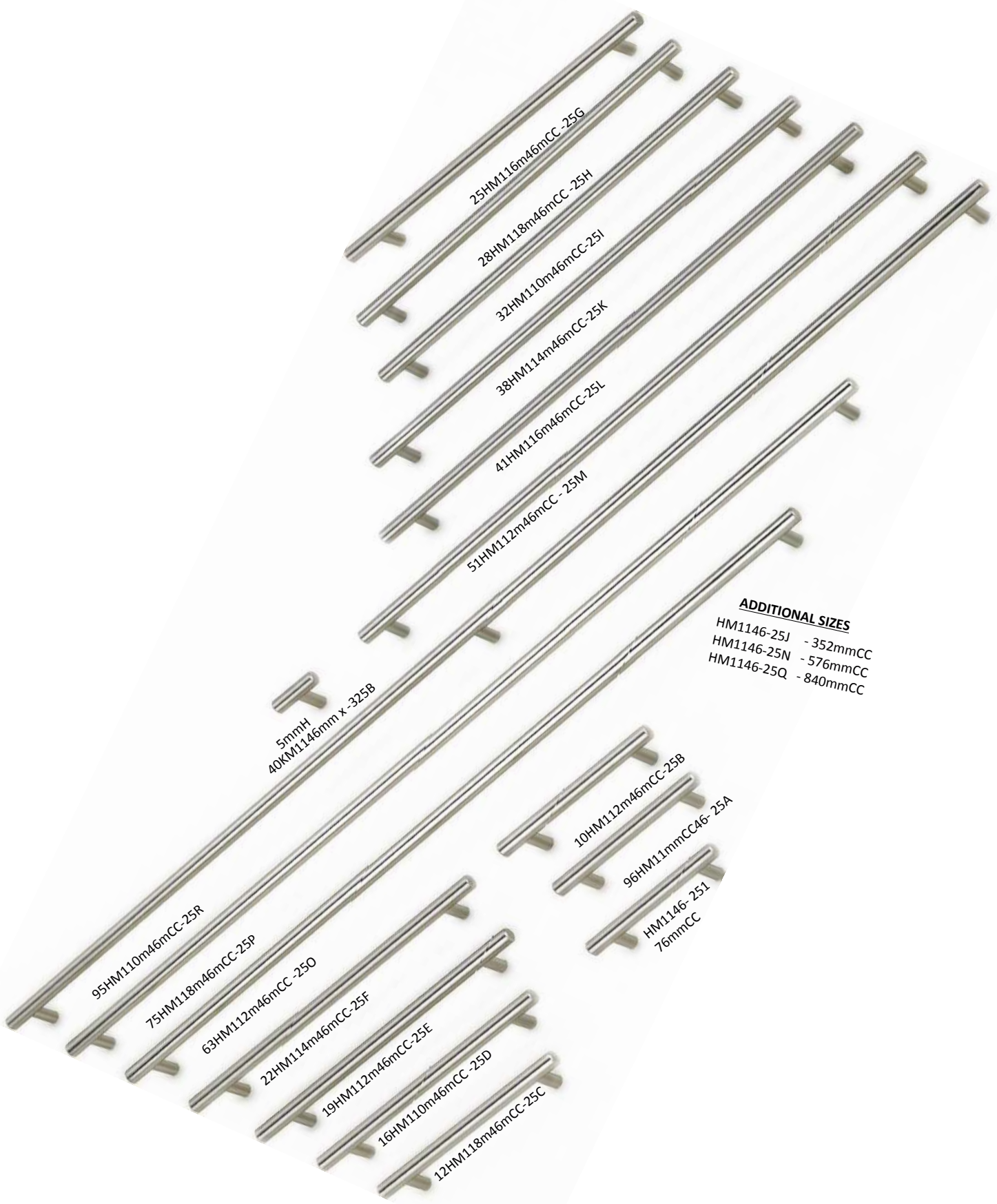

ADDITIONAL SIZES
HM1146-25J - 352mmCC
HM1146-25N - 576mmCC
HM1146-25Q - 840mmCC

5mmH
40KM1146mm x-325B

95HM110m46mCC-25R

75HM118m46mCC-25P

63HM112m46mCC-25O

22HM114m46mCC-25F

19HM112m46mCC-25E

16HM110m46mCC-25D

12HM118m46mCC-25C

10HM112m46mCC-25B

96HM11mmCC46-25A

HM1146-25I
76mmCC

KM8106-25B
19mm x 24mmH

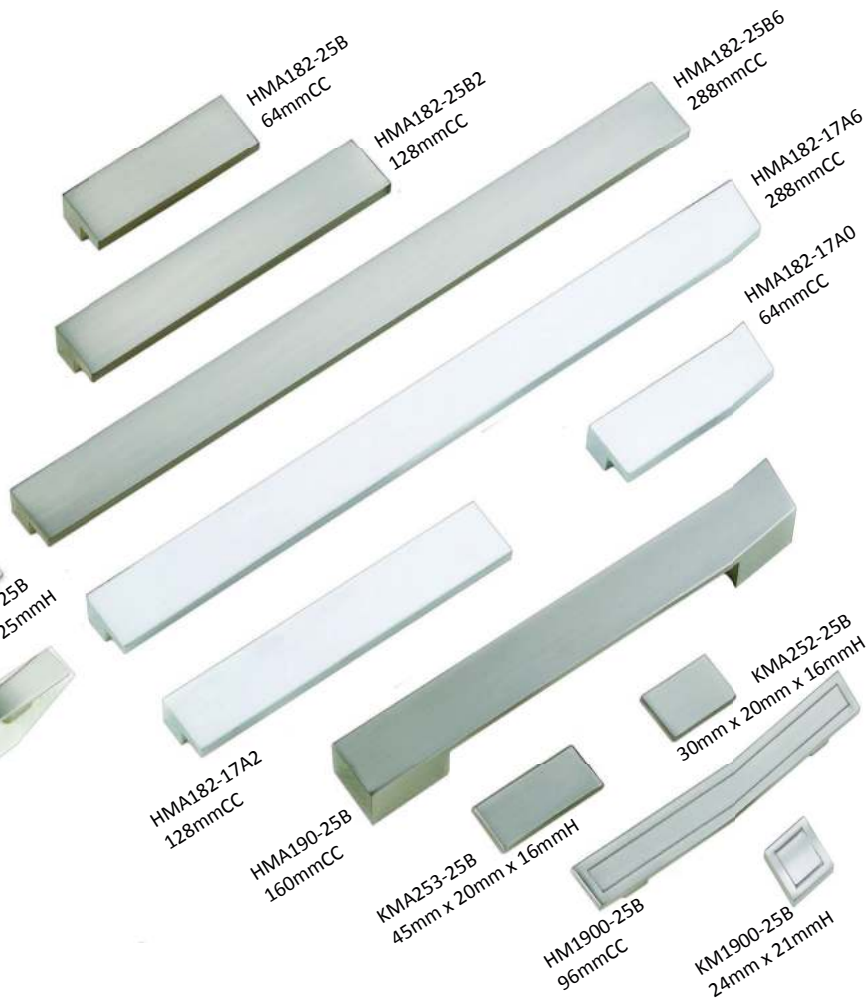
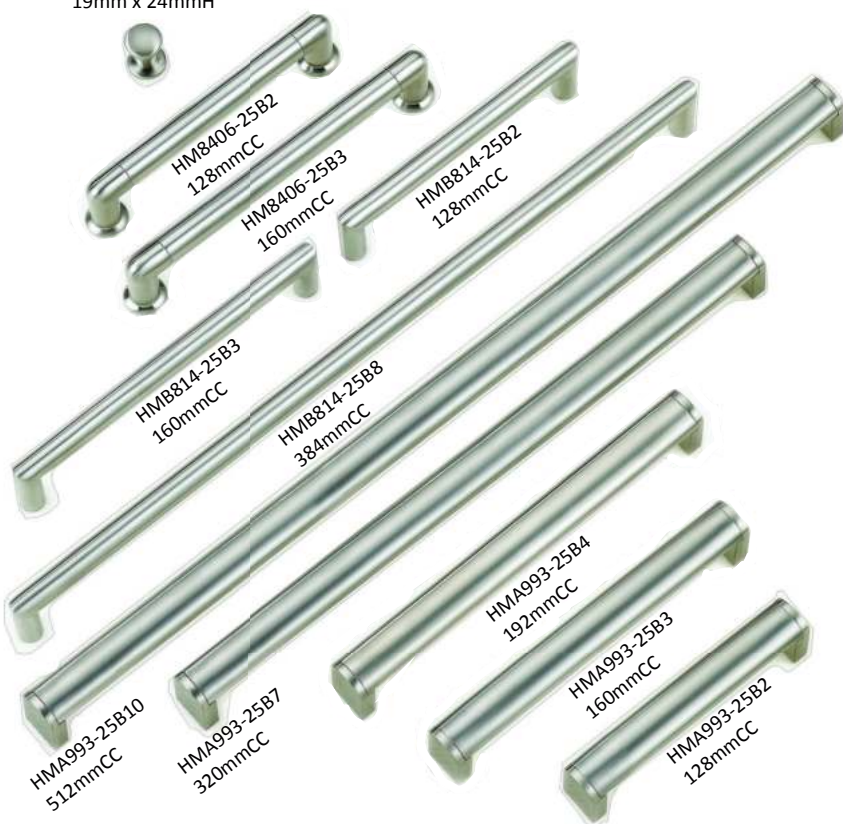

KM8103-25
B2mm x 25mmH



KM8103-17
32mm x 25mmH

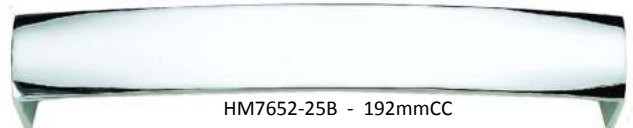

KM0040-25B
18mm x 28mmH



KM2083-93B
B2mm x 31mmH



HM3940-25B
64mmCC



HM0683-17A
96mmCC



KMA402-17A
25mm x 15mmH



HMA194-17A
128mmCC



HM0683-25B
96mmCC



KMA402-25B
25mm x 15mmH



HMA194-25B
128mmCC



HM0683-95A
96mmCC



HMA194-95A
128mmCC



HM0683-33A
96mmCC



HM0001-02A
102mmCC



KM0001-02A
37mm x 19mm
26mmH



KM0002-09C
32mm x 26mmH



HM0002-09C
102mmCC



HM0001-09C
102mmCC



KM0001-09C
37mm x 19mm
26mmH



KM0002-95A
32mm x 26mmH



HM0002-95A
102mmCC



HM0001-95A
102mmCC



KM0001-95A
37mm x 19mm
26mmH



KM0002-17A
32mm x 26mmH



HM0002-17A
102mmCC



HM0001-17A
102mmCC



KM0001-17A
37mm x 19mm
26mmH



HM0001-08B
102mmCC



KM0001-08B
37mm x 19mm x 26mmH



HMA445-09A
76mmCC



HMA445-50A
76mmCC



HMA445-25B
76mmCC



HMA445-50B
76mmCC



HMA445-33A
76mmCC



HMA445-43A
76mmCC



HMA445-95A
76mmCC



KM0698-09A
24mm x 25mmH



KM0698-50A
24mm x 25mmH



KM0698-25B
24mm x 25mmH



KM0698-50B
24mm x 25mmH



KM0698-33A
24mm x 25mmH



KM0698-43A
24mm x 25mmH



KM0698-95A
24mm x 25mmH



HM0743-09A
64mmCC



HM0743-50A
64mmCC



HM0743-25B
64mmCC



HM0743-50B
64mmCC



HM0743-33A
64mmCC



HM0743-43A
64mmCC



HM0743-95A
64mmCC



KM2557-02B
55mm x 18mm



KM3294-02A
30mm x 29mmH



KM3294-02A
30mm x 29mmH



KM2557-02A
64mm x 25mm



HM3219-02A
65mm x 25mm



G-2125-02A (RIGHT)
G-2126-02A (LEFT)



HM3247-09B - 56mmCC



KM2461-33A
30mm x 20mmH



KM2664-33A
29mm x 25mmH



HM3305-33A
96mmCC



HM3306-33A
75mm x 47mm



KM2558-02A
35mm x 48mmH



HM2554-02A
96mmCC



HM3245-09B
76mmCC



HM2648-09A
96mmCC



HM3247-02A
56mmCC



HM2112-02B
128mmCC



HM4587-02A
89mmCC



KM6081-09A
30mm x 27mmH



KMA038-09B
26mm x 26mmH



KM3409-09A
25mm x 25mmH



KM2007-09A
27mm x 25mmH



HM0653-09A
128mmCC



HMA029-09A
128mmCC

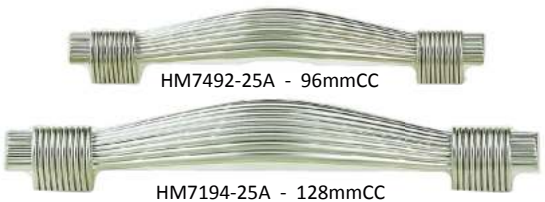
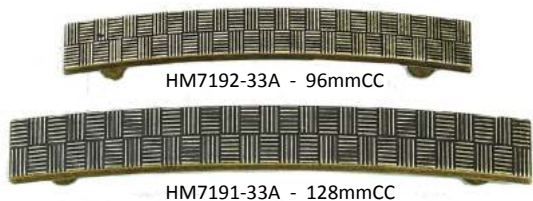
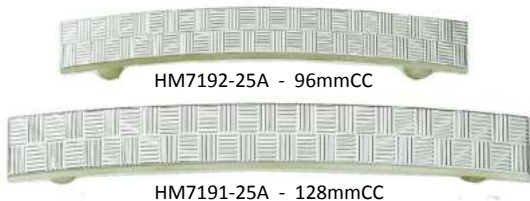
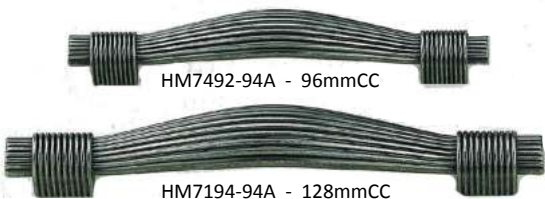
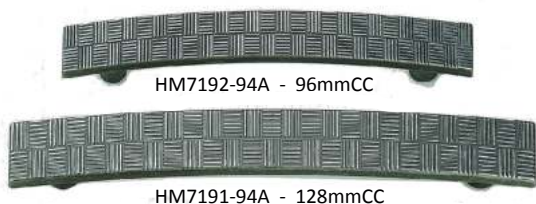



FINISHES

- BLACK NICKEL
- BRUSHED NICKEL
- MATT BLACK
- POLISHED CHROME

KM8211-02C
30mm x 25mmH



HM8372-02C5
256mmCC

HM8372-02C4
192mmCC

HM8372-02C3
160mmCC

HM8372-02C2
128mmCC

HM8372-02C1
96mmCC

KM8211-25B
30mm x 25mmH



HM8372-25B1
96mmCC

HM8372-02A5
256mmCC

HM8372-02A4
192mmCC

HM8372-02A3
160mmCC

HM8372-02A2
128mmCC

HM8372-94B1
96mmCC

KM8211-94B
30mm x 25mmH

HM8372-02A1
96mmCC

KM8211-02A
30mm x 25mmH

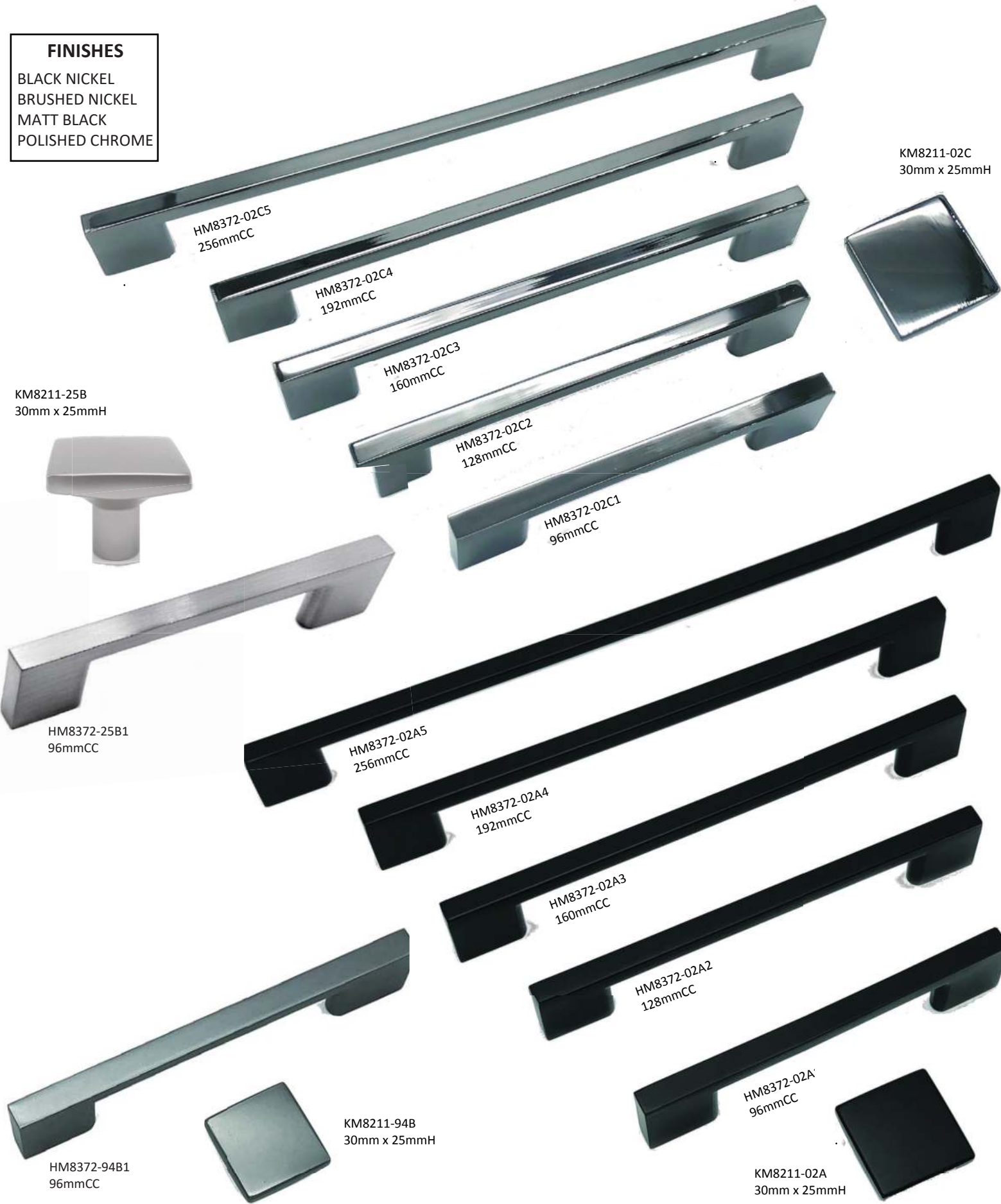



SPECIAL ORDER ITEMS. PLEASE VISIT WWW.TOPKNOBS.COM FOR A COMPLETE LIST OF PRODUCTS.



SPECIAL ORDER ITEMS. PLEASE VISIT WWW.ATLASHOMEWARES.COM FOR A COMPLETE LIST OF PRODUCTS.



LARKIN



RICHARD



RENZO



BOSWELL



CARMEN



HAYWORTH



ELARA



ALVAR



BELLA



DUVAL



RAE



DELGADO

SPECIAL ORDER ITEMS. PLEASE VISIT WWW.HARDWARERESOURCES.COM FOR A COMPLETE LIST OF PRODUCTS.



GIBSON



WALKER



EDGEFIELD



KNOX



SEDONA



AIDEN



ZACHARY



ARCHED



DRAKE



COSGROVE



WESTBURY



LINDOS

SPECIAL ORDER ITEMS. PLEASE VISIT WWW.HARDWARERESOURCES.COM FOR A COMPLETE LIST OF PRODUCTS.

RAPID HINGES

RDC-A-9881
Surface Mounted
Hydraulic Door Closer
Smart Design



RDC-B-02
Door Selector
Stainless Steel



RDC-B-01
Door Selector
Stainless Steel



RDH-A-001
Stainless Steel #304



RBH-B-3043-4
SS Hinge and Bearing
SUS #304



RDF-A-001-A
Barrel Bolt
Stainless Steel



HINGE MACHINE



HINGE MACHINE

-
- SINGLE HANDED OPERATION, QUICK TAB SETTING WITH DIAL INDICATOR
- BOARD PLACEMENT GUIDE PROVIDES FAST AND CONSISTENT ALIGNMENT
- FULLY ADJUSTABLE UP AND DOWN SPEED SETTING
- 220V SINGLE PHASE BORING MACHINE, 1.5 HP, 3450 RPM
- SHIPS PREASSEMBLED WITH BITS & LONG ARM EURO HINGE RAM



OLYMPIA

CONCEALED HINGE WITH ADJUSTABLE SOFT-CLOSE

(19 mm overlay)



THICK DOOR CONCEALED HINGE WITH ADJUSTABLE SOFT-CLOSE



H360-26/C26/D26

GLASS DOOR FACE PLATES



GH-360FP-CR



GH-360FP-SN



GH-360FP-GP



GH-360FP-BL

MOUNTING PLATES



360-P6WT



360-P3W-53T

BODY COVERS

360HC-19H26-NI

(19 and 26 mm OVERLAY)



- Available Hinge
360 (19 mm overlay type)
H360 (26 mm overlay type)

360HC-9H16-NI

(9 and 16 mm OVERLAY)



- Available Hinge
360 (9 mm overlay type)
H360 (16 mm overlay type)

360HC-0H0-NI

(INSET)



- Available Hinge
360 (inset type)
H360 (inset type)

FACE FRAME BRACKET



FFCB-HG-1



85° ANGLE LIMITER (THICK DOOR)

H360-85



- Limits the opening angle from 100° to 85° of the H360 hinge. (The H360 is a thick door model of OLYMPIA hinge series.)

Item No.	Material	Color
H360-85	PBT	Grey

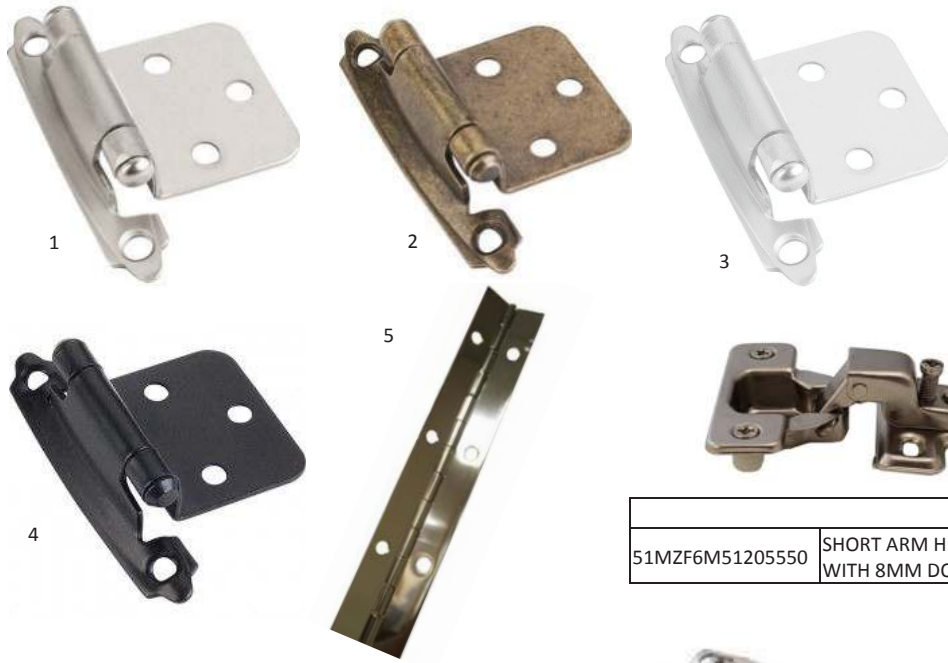

DECORATIVE AND GLASS HINGES		
1	GM0006SC17A	BRIGHT NICKEL SELF CLOSING HINGE
2	GM0006SC09A	ANTIQUE BRASS SELF CLOSING HINGE
3	GM0006SC34A	WHITE SELF CLOSING HINGE
4	H5011BLK	BLACK SELF CLOSE HINGE)
5	ASSORTMENT OF PIANO HINGES (1 1/4" & 1 1/2")	

FACE FRAME AND MINI HINGES			
51MZ6M51205550	SHORT ARM HINGE & PLATE WITH 8MM DOWELS	GM6011CM25B	SOFT CLOSING SHORT ARM HINGE & PLATE WITH CAM



SPECIAL ORDER ITEM: SOFT CLOSE FACE FRAME HINGES WITH DOWELS (ALSO AVAILABLE WITHOUT DOWELS)					
1	7390-716	7/16" OVERLAY COMPACT HINGE	2	9392-000	1-1/2" OVERLAY COMPACT HINGE
3	4393-000	1-3/8" OVERLAY COMPACT HINGE			

LIFTS

CEMUX



TK306 - LIFTER PRO	
TK306	37MM STANDARD CABINET DRILLING



TK223-LIFTER PRO PLUS	
TK223	MANY WEIGHT VARIATIONS

TK123-HINGELESS LIFT UP SYSTEM	
TK123A	2.7-3.7KG
TK123B	3.8-4.8KG
TK123C	4.9-6.0KG



TK127-LIFT UP SYSTEM	
TK127AL	2.0-4.0KG, Left side
TK127AR	2.0-4.0KG, Right side
TK127BL	3.0-6.0KG, Left side
TK127BR	3.0-6.0KG, Right side



LIFTER	
TK417.080	80 NEWTON
TK417.100	100 NEWTON
TK417.060	60 NEWTON



H box - 84mm height

Drawer H84; Soft-close/Push-open



- Slim wall
- Soft-close/Push-open
- Full extension
- 84 mm drawer height
- ±2mm up & down adjustment;
- ±1.5mm left & right adjustment
- Length from 270-550mm
- Cycles with loading 40kg is 100,000
- Loading capacity is 40 KG

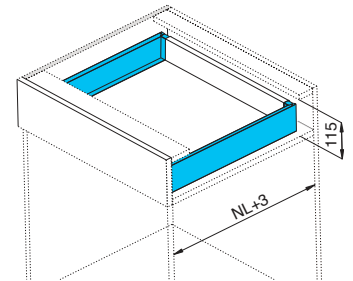

Components	NL	Soft-close		Push-open		Package
		White	Grey	White	Grey	
	270	H1301-270W	H1301-270G	H1301-270PW	H1301-270PG	6 sets
	300	H1301-300W	H1301-300G	H1301-300PW	H1301-300PG	6 sets
	350	H1301-350W	H1301-350G	H1301-350PW	H1301-350PG	6 sets
	400	H1301-400W	H1301-400G	H1301-400PW	H1301-400PG	6 sets
	450	H1301-450W	H1301-450G	H1301-450PW	H1301-450PG	6 sets
	500	H1301-500W	H1301-500G	H1301-500PW	H1301-500PG	6 sets
	550	H1301-550W	H1301-550G	H1301-550PW	H1301-550PG	6 sets

* One set included one pair of slides, sides, rear brackets, front brackets and cover caps

H box - 116mm height

Drawer H116; Soft-close/Push-open



- Slim wall
- Soft-close/Push-open
- Full extension
- 116 mm drawer height
- ±2mm up & down adjustment;
- ±1.5mm left & right adjustment
- Length from 270-550mm
- Cycles with loading 40kg is 100,000
- Loading capacity is 40 KG

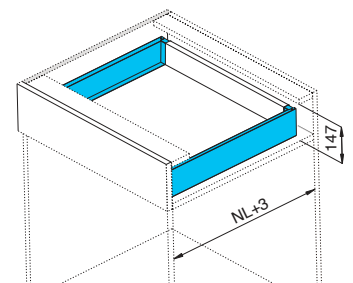

Components	NL	Soft-close		Push-open		Package
		White	Grey	White	Grey	
	270	H1302-270W	H1302-270G	H1302-270PW	H1302-270PG	6 sets
	300	H1302-300W	H1302-300G	H1302-300PW	H1302-300PG	6 sets
	350	H1302-350W	H1302-350G	H1302-350PW	H1302-350PG	6 sets
	400	H1302-400W	H1302-400G	H1302-400PW	H1302-400PG	6 sets
	450	H1302-450W	H1302-450G	H1302-450PW	H1302-450PG	6 sets
	500	H1302-500W	H1302-500G	H1302-500PW	H1302-500PG	6 sets
	550	H1302-550W	H1302-550G	H1302-550PW	H1302-550PG	6 sets

* One set included one pair of slides, sides, rear brackets, front brackets and cover caps

H box - 167mm height

Drawer H167; Soft-close/Push-open



- Slim wall
- Soft-close
- Full extension
- 167 mm drawer height
- ± 2 mm up & down adjustment;
- ± 1.5 mm left & right adjustment
- Length from 270-550mm
- Cycles with loading 40kg is 100,000
- Loading capacity is 40 KG

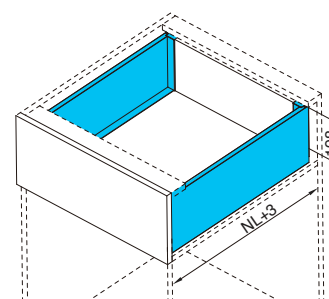

Components	NL	Soft-close		Push-open		Package
		White	Grey	White	Grey	
	270	H1303-270W	H1303-270G	H1303-270PW	H1303-270PG	5 sets
	300	H1303-300W	H1303-300G	H1303-300PW	H1303-300PG	5 sets
	350	H1303-350W	H1303-350G	H1303-350PW	H1303-350PG	5 sets
	400	H1303-400W	H1303-400G	H1303-400PW	H1303-400PG	5 sets
	450	H1303-450W	H1303-450G	H1303-450PW	H1303-450PG	5 sets
	500	H1303-500W	H1303-500G	H1303-500PW	H1303-500PG	5 sets
	550	H1303-550W	H1303-550G	H1303-550PW	H1303-550PG	5 sets

* One set included one pair of slides, sides, rear brackets, front brackets and cover caps

H box - 199mm height

Drawer H199; Soft-close/Push-open



- Slim wall
- Soft-close
- Full extension
- 199 mm drawer height
- ± 2 mm up & down adjustment;
- ± 1.5 mm left & right adjustment
- Length from 270-550mm
- Cycles with loading 40kg is 100,000
- Loading capacity is 40 KG

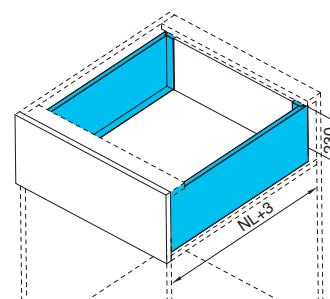

Components	NL	Soft-close		Push-open		Package
		White	Grey	White	Grey	
	270	H1304-270W	H1304-270G	H1304-270PW	H1304-270PG	4 sets
	300	H1304-300W	H1304-300G	H1304-300PW	H1304-300PG	4 sets
	350	H1304-350W	H1304-350G	H1304-350PW	H1304-350PG	4 sets
	400	H1304-400W	H1304-400G	H1304-400PW	H1304-400PG	4 sets
	450	H1304-450W	H1304-450G	H1304-450PW	H1304-450PG	4 sets
	500	H1304-500W	H1304-500G	H1304-500PW	H1304-500PG	4 sets
	550	H1304-550W	H1304-550G	H1304-550PW	H1304-550PG	4 sets

* One set included one pair of slides, sides, rear brackets, front brackets and cover caps

H box - 84mm height

Drawer glass side H84; Soft-close/Push-open



- Slim glass wall
- Soft-close
- Full extension
- 84 mm drawer height
- ±2mm up & down adjustment;
- ±1.5mm left & right adjustment
- Length from 350-550mm
- Cycles with loading 40kg is 100,000
- Loading capacity is 40 KG

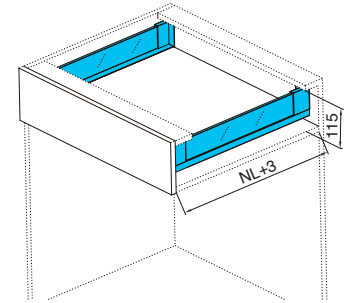

Components	NL	Soft-close		Push-open		Package
		White	Grey	White	Grey	
	270	H1311-270W	H1311-270G	H1311-270PW	H1311-270PG	6 sets
	300	H1311-300W	H1311-300G	H1311-300PW	H1311-300PG	6 sets
	350	H1311-350W	H1311-350G	H1311-350PW	H1311-350PG	6 sets
	400	H1311-400W	H1311-400G	H1311-400PW	H1311-400PG	6 sets
	450	H1311-450W	H1311-450G	H1311-450PW	H1311-450PG	6 sets
	500	H1311-500W	H1311-500G	H1311-500PW	H1311-500PG	6 sets
	550	H1311-550W	H1311-550G	H1311-550PW	H1311-550PG	6 sets

* One set included one pair of slides, sides, rear brackets, front brackets and cover caps

H box - 167mm height

Drawer glass side H167; Soft-close/Push-open



- Slim glass wall
- Soft-close
- Full extension
- 167 mm drawer height
- ±2mm up & down adjustment;
- ±1.5mm left & right adjustment
- Length from 350-550mm
- Cycles with loading 40kg is 100,000
- Loading capacity is 40 KG

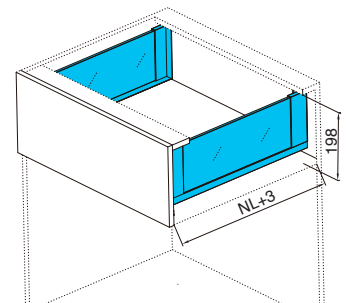

Components	NL	Soft-close		Push-open		Package
		White	Grey	White	Grey	
	270	H1313-270W	H1313-270G	H1313-270PW	H1313-270PG	5 sets
	300	H1313-300W	H1313-300G	H1313-300PW	H1313-300PG	5 sets
	350	H1313-350W	H1313-350G	H1313-350PW	H1313-350PG	5 sets
	400	H1313-400W	H1313-400G	H1313-400PW	H1313-400PG	5 sets
	450	H1313-450W	H1313-450G	H1313-450PW	H1313-450PG	5 sets
	500	H1313-500W	H1313-500G	H1313-500PW	H1313-500PG	5 sets
	550	H1313-550W	H1313-550G	H1313-550PW	H1313-550PG	5 sets

* One set included one pair of slides, sides, rear brackets, front brackets and cover caps

H box - 199mm height

Drawer glass side H199; Soft-close/Push-open



- Slim frosted glass wall
- Soft-close
- Full extension
- 199 mm drawer height
- ±2mm up & down adjustment;
- ±1.5mm left & right adjustment
- Length from 350-550mm
- Cycles with loading 40kg is 100,000
- Loading capacity is 40 KG

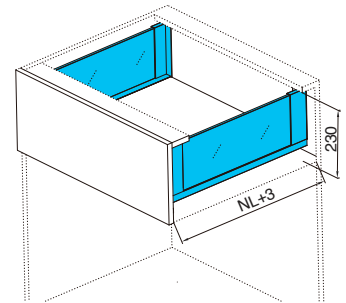

Components	NL	Soft-close		Push-open		Package
		White	Grey	White	Grey	
	270	H1314-270W	H1314-270G	H1314-270PW	H1314-270PG	4 sets
	300	H1314-300W	H1314-300G	H1314-300PW	H1314-300PG	4 sets
	350	H1314-350W	H1314-350G	H1314-350PW	H1314-350PG	4 sets
	400	H1314-400W	H1314-400G	H1314-400PW	H1314-400PG	4 sets
	450	H1314-450W	H1314-450G	H1314-450PW	H1314-450PG	4 sets
	500	H1314-500W	H1314-500G	H1314-500PW	H1314-500PG	4 sets
	550	H1314-550W	H1314-550G	H1314-550PW	H1314-550PG	4 sets

* One set included one pair of slides, sides, rear brackets, front brackets and cover caps

H box

Inset drawer accessories for H84

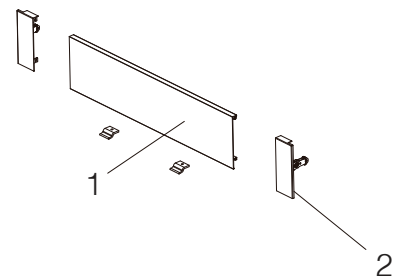

1. Front panel - normal aluminum
* DIY cut : Length = LW-100

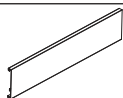

L	White	Grey	Package
1200	H1321200W	H1321200G	20 pcs

2. Inset drawer front bracket left/right



	White	Grey	Package
	H130200W	H130200G	50 pairs

H box

Inset drawer - Front panel and H54 glass for drawer H84

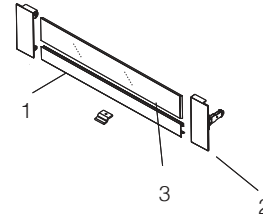

1. Front panel - low aluminum
* DIY cut : Length = LW-100

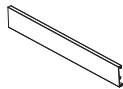

L	White	Grey	Package
1200	H1331200W	H1331200G	20 pcs

2. Inset drawer front bracket left/right



	White	Grey	Package
	H131200W	H131200G	50 pairs

3. Front H54 glass panel

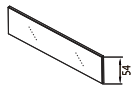

KB	Frosted	Transparent	Package
600	H1410476F	H1410476T	20 pcs
800	H1410676F	H1410676T	20 pcs
900	H1410776F	H1410776T	20 pcs

H box

Inset drawer - Front panel and rail for drawer H167

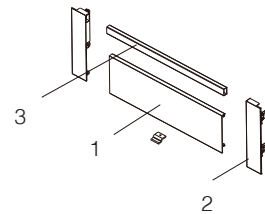

1. Front panel - normal aluminum
* DIY cut : Length = LW-100



L	White	Grey	Package
1200	H1321200W	H1321200G	20 pcs

2. Inset drawer front bracket left/right

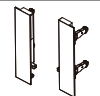

	White	Grey	Package
	H130500W	H130500G	20 pairs

3. Front square rail
* DIY cut : Length = LW-88



L	White	Grey	Package
1200	HF321200W	HF321200G	50 pcs

H box

Inset drawer - Front panel and H70 glass for drawer H167

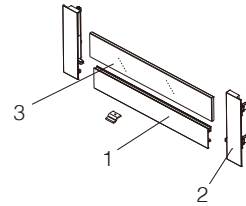

1. Front panel - low aluminum
* DIY cut : Length = LW-100

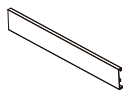

L	White	Grey	Package
1200	H1331200W	H1331200G	20 pcs

2. Inset drawer front bracket left/right



	White	Grey	Package
	H130300W	H130300G	20 pairs

3. Front H70 glass panel

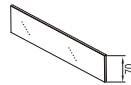

KB	Frosted	Transparent	Package
600	H1360476F	H1360476T	20 pcs
800	H1360676F	H1360676T	20 pcs
900	H1360776F	H1360776T	20 pcs

H box

Inset drawer - Front panel and H138 glass for drawer glass side H167

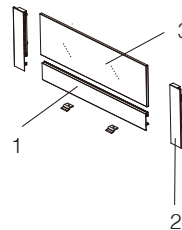

1. Front panel - low aluminum
* DIY cut : Length = LW-100

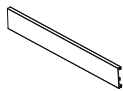

L	White	Grey	Package
1200	H1331200W	H1331200G	20 pcs

2. Inset drawer front bracket left/right



	White	Grey	Package
	H130400W	H130400G	20 pairs

3. Front H138 glass panel

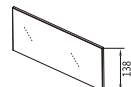

KB	Frosted	Transparent	Package
600	H1370476F	H1370476T	20 pcs
800	H1370676F	H1370676T	20 pcs
900	H1370776F	H1370776T	20 pcs

H box

Inset drawer - Front panel and rail for drawer H199

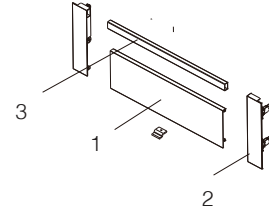

1. Front panel - normal aluminum
* DIY cut : Length = LW-100

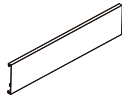

L	White	Grey	Package
1200	H1321200W	H1321200G	20 pcs

2. Inset drawer front bracket left/right



	White	Grey	Package
	H130800W	H130800G	20 pairs

3. Front square rail
* DIY cut : Length = LW-88



L	White	Grey	Package
1200	HF321200W	HF321200G	50 pcs

H box

Inset drawer - Front panel and H102 glass for drawer glass side H199

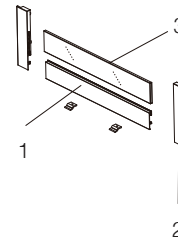

1. Front panel - low aluminum
* DIY cut : Length = LW-100

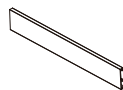

L	White	Grey	Package
1200	H1331200W	H1331200G	20 pcs

2. Inset drawer front bracket left/right



	White	Grey	Package
	H130600W	H130600G	20 pairs

3. Front H102 glass panel

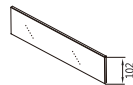

KB	Frosted	Transparent	Package
600	H1390476F	H1390476T	20 pcs
800	H1390676F	H1390676T	20 pcs
900	H1390776F	H1390776T	20 pcs

H box

Inset drawer - Front panel and H170 glass for drawer H199

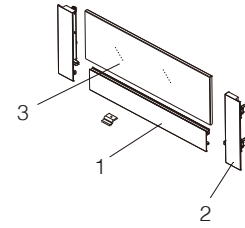

1. Front panel - low aluminum
* DIY cut : Length = LW-100

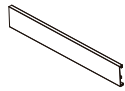

L	White	Grey	Package
1200	H1331200W	H1331200G	20 pcs

2. Inset drawer front bracket left/right



	White	Grey	Package
	H130700W	H130700G	20 pairs

3. Front H170 glass panel

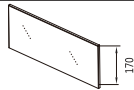

KB	Frosted	Transparent	Package
600	H1400476F	H1400476T	20 pcs
800	H1400676F	H1400676T	20 pcs
900	H1400776F	H1400776T	20 pcs



H84



H167



H199

BBM box - 86mm height

Drawer H86; Soft-close/Non soft-close



- Slim wall
- Soft-close/Non soft-close
- Full extension
- White colour
- 86 mm drawer height
- ±1.5mm up & down adjustment;
- Length from 270-600mm
- Loading capacity is 25 KG

NL	Soft-close	Non Soft-close	Soft-close	Non Soft-close	Package
	Screw on		10mm press in dowel		
270	BBM11S-270	BBM11N-270	BBM01S-270	BBM01N-270	10 sets
300	BBM11S-300	BBM11N-300	BBM01S-300	BBM01N-300	10 sets
350	BBM11S-350	BBM11N-350	BBM01S-350	BBM01N-350	10 sets
400	BBM11S-400	BBM11N-400	BBM01S-400	BBM01N-400	10 sets
450	BBM11S-450	BBM11N-450	BBM01S-450	BBM01N-450	10 sets
500	BBM11S-500	BBM11N-500	BBM01S-500	BBM01N-500	10 sets
550	BBM11S-550	BBM11N-550	BBM01S-550	BBM01N-550	10 sets
600	BBM11S-600	BBM11N-600	BBM01S-600	BBM01N-600	10 sets

BBM box - 150mm height

Drawer H150; Soft-close/Non soft-close



- Slim wall
- Soft-close/Non soft-close
- Full extension
- White colour
- 150 mm drawer height
- ±1.5mm up & down adjustment;
- Length from 270-600mm
- Loading capacity is 25 KG

NL	Soft-close	Non Soft-close	Soft-close	Non Soft-close	Package
	Screw on		10mm press in dowel		
270	BBM12S-270	BBM12N-270	BBM02S-270	BBM02N-270	10 sets
300	BBM12S-300	BBM12N-300	BBM02S-300	BBM02N-300	10 sets
350	BBM12S-350	BBM12N-350	BBM02S-350	BBM02N-350	10 sets
400	BBM12S-400	BBM12N-400	BBM02S-400	BBM02N-400	10 sets
450	BBM12S-450	BBM12N-450	BBM02S-450	BBM02N-450	10 sets
500	BBM12S-500	BBM12N-500	BBM02S-500	BBM02N-500	10 sets
550	BBM12S-550	BBM12N-550	BBM02S-550	BBM02N-550	10 sets
600	BBM12S-600	BBM12N-600	BBM02S-600	BBM02N-600	10 sets

RT drawer slide - RT213 (Synchronised motion)

Soft-close; Full extension; 3-D adjustment; 16mm drawer



- Soft Close
- Full Extension
- Galvanized Steel
- Loading Capacity is 35kg
- Length from 250-550mm
- 0-3mm height adjustment
- 1.5mm right/left adjustment
- 0-5mm depth adjustment on slide

NL	Item No.	Package	Remark
250	RT213-250	10 sets	Package includes A. Left & right drawer slide B. Locking devices
300	RT213-300	10 sets	
350	RT213-350	10 sets	
400	RT213-400	10 sets	
450	RT213-450	10 sets	
500	RT213-500	10 sets	
550	RT213-550	10 sets	

Installation dimensions

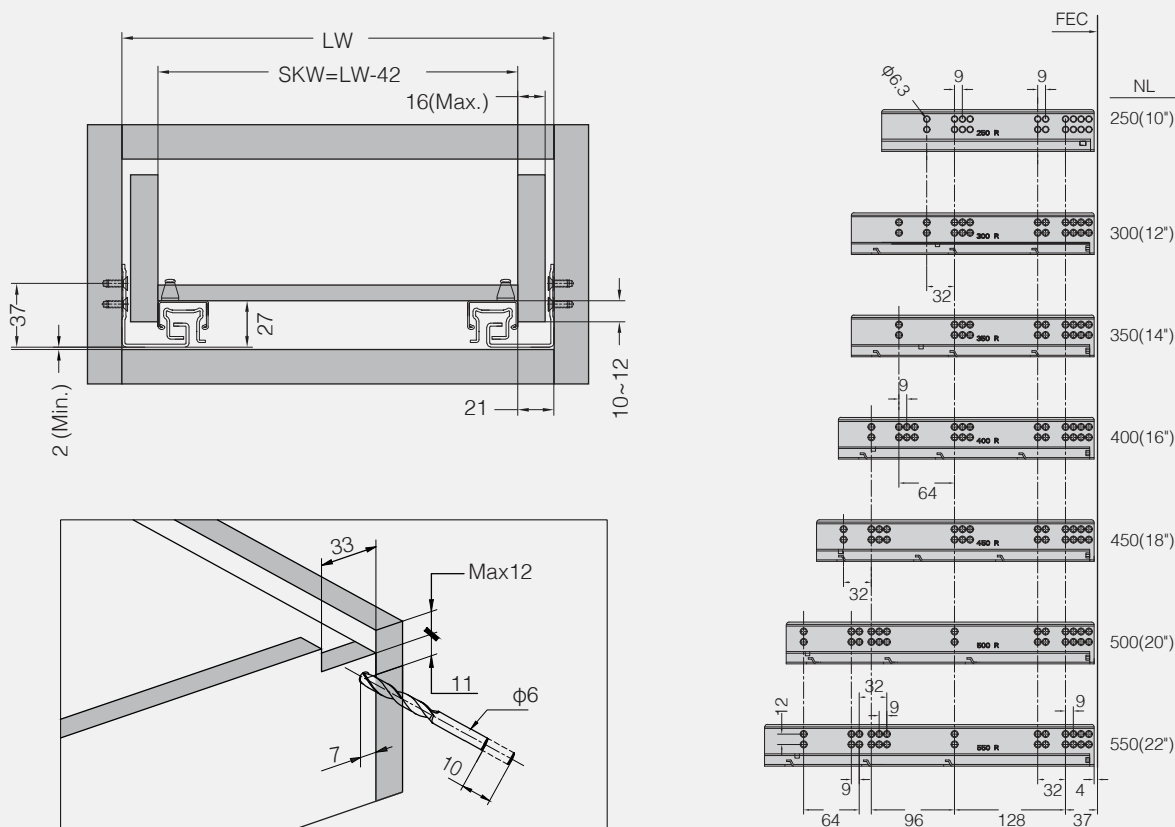

PRESS MACHINE

ASK US ABOUT A FREE MACHINE

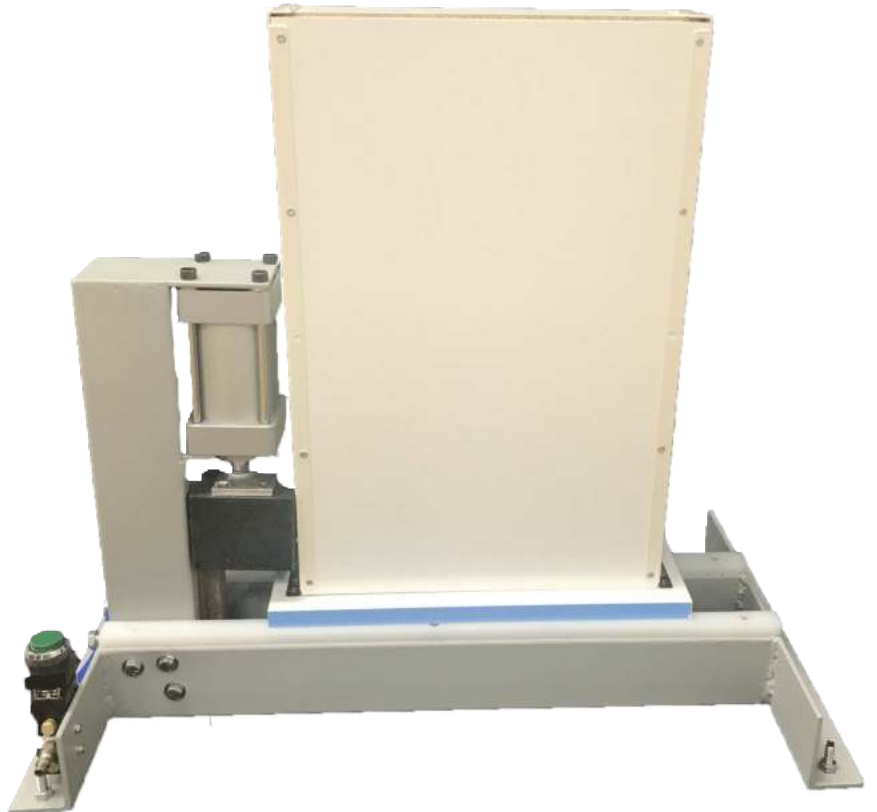
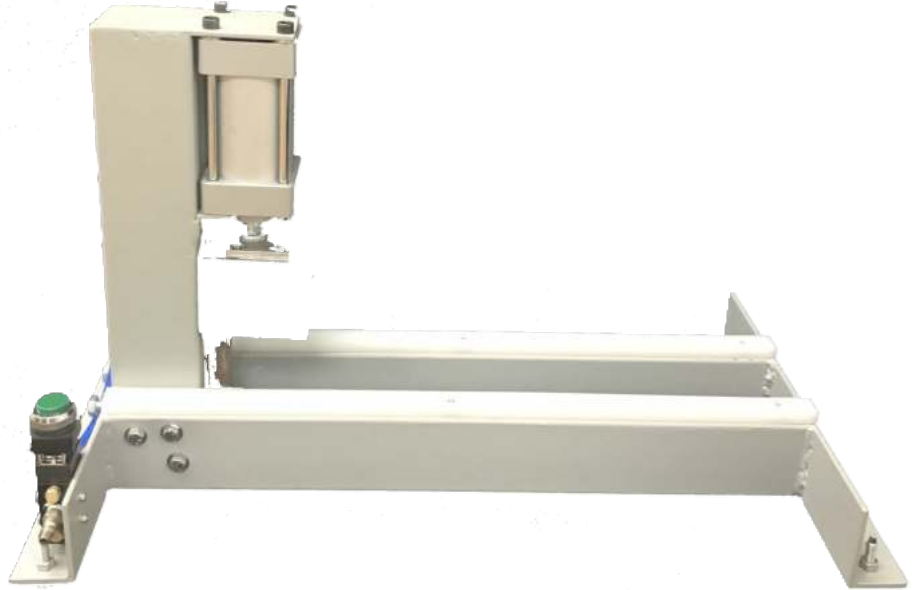

HARDWARE RESOURCES SLIDES



HEAVY DUTY DURA CLOSE® SOFT-CLOSE SLIDE

ITEM no: 303-325-26
26" / 660mm
Side Mount



STANDARD DUTY CREAM WHITE SELF-CLOSE SLIDE

SERIES no: 5000CW
3/4 extension slide travel with 75 lb load rating
Side or Back Mount



HEAVY DUTY SOFT CLOSE UNDERMOUNT SLIDE

SERIES no: USE58-100
100 lb Full Extension
Undermount

SLIDE ACCESSORIES

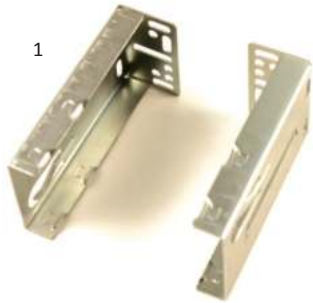

MOUNTING BRACKETS/SPACERS		
1	MM9453CM37A	METAL SOCKET FOR FULL EXTENSION SLIDE
2	MP1004SP34A	WHITE 32MM SPACER FOR METAL SLIDE
3	MP5012MP34A	WHITE 1 x 2" PLASTIC MENDING PLATE

CEMUX FLUSH SLIDING DOORS



CLOSE IN LINE DOOR SLIDING SYSTEM

ITEM no: SWL001
MATERIAL: IRON
60KG DOOR LOADING CAPACITY
1500-3000mm CABINET WIDTH
18-45mm DOOR THICKNESS



BOTTOM RUNNER DOOR SLIDING SYSTEM

ITEM no: SWB005
MATERIAL: IRON
10-50KG DOOR LOADING CAPACITY
500-1200mm DOOR WIDTH



TOP HANGING DOOR SLIDING SYSTEM

ITEM no: SWT003
MATERIAL: IRON
SOFT CLOSE SYSTEM
20-80KG DOOR LOADING CAPACITY
16-46mm DOOR THICKNESS



FOLDING DOOR SLIDING SYSTEM

ITEM no: SWF002
MATERIAL: IRON
SOFT CLOSE SYSTEM
20KG DOOR LOADING CAPACITY
300-600mm DOOR WIDTH

ATLAS



PARKER BATH TOWEL BAR
16 1/2 INCH PULL / 22 INCH PULL



PARKER BATH TOWEL RING
8 1/2" LENGTH / 4 3/4" WIDTH



SUTTON BATH TISSUE HOOK
6 5/8" LENGTH / 3 1/2" WIDTH



SUTTON BATH TOWEL RING
6 5/8" LENGTH / 3 3/4" WIDTH



AXEL BATH HOOK
2 1/4" LENGTH / 1 13/16" WIDTH



LEGACY BATH TISSUE HOOK
7" LENGTH / 2" WIDTH



MANDALAY BATH TISSUE HOOK
6 5/8" LENGTH / 2 1/4" WIDTH



LEGACY BATH GLASS SHELF
26 3/4" LENGTH / 2" WIDTH



GRATITUDE BATH TISSUE HOOK
7" LENGTH / 2" WIDTH

HARDWARE RESOURCES



NEWBURY DOUBLE ROBE HOOK
BHE3-02



BRIDGEPORT 24" SINGLE TOWEL BAR
BHE1-04



BRIDGEPORT TOWEL RING
BHE1-06



NEWBURY TOILET PAPER HOLDER
BHE3-01



FAIRVIEW SPRING TOILET PAPER HOLDER
BHE5-01



BRIDGEPORT DOUBLE ROBE HOOK
BHE1-02



S-3014-C
850mm x 475mm x 600mm



S-3021-C
740mm x 650mm - 700mm



S-3002-C
860-965mm x 530mm x 530mm



S-2891-C
310mm x 475mm x 640mm



S-2616-A
580mm x 490mm x 160mm



S-2574-G
260mm x 440mm x 300mm



S-2498-A
280mm x 460mm x 405mm



S-2336-C
580mm x 482mm x 145mm



S-2312-C
566mm x 500mm x 130mm

SOFT CLOSING
SWIVEL SYSTEM



TURNING LARDER UNIT WITH WOOD SHELF BASES (4, 5 & 6 BASKETS)

	HEIGHT 1250-1400MM			HEIGHT 1550-1700MM			
	C(MM)	HEIGHT	SIZE	C (MM)	HEIGHT	SIZE	
4 BASKET	300	S-1719	230 X 500MM	5 BASKET	300	S-1731	230 X 500MM
	350	S-1720	280 X 500MM		350	S-1732	280 X 500MM
	400	S-1721	330 X 500MM		400	S-1733	330 X 500MM
	450	S-1722	380 X 500MM		450	S-1734	380 X 500MM
	500	S-1723	430 X 500MM		500	S-1735	430 X 500MM
6 BASKET	HEIGHT 1850-2000MM			C=OUTSIDE CABINET SIZE			
	300	S-1743	230 X 500MM	1400MM = 55.11 INCHES			
	350	S-1744	280 X 500MM	1700MM = 66.92 INCHES			
	400	S-1745	330 X 500MM	2000MM = 78.74 INCHES			
	450	S-1746	380 X 500MM				
	500	S-1747	430 X 500MM				

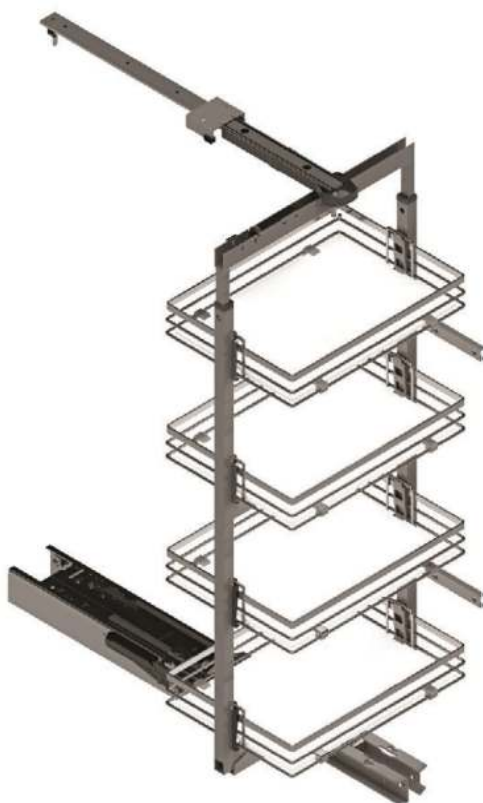

SOFT CLOSING



LARDER UNIT WITH WOOD SHELF BASES

	HEIGHT 1250-1400MM			HEIGHT 1550-1700MM			
	C(MM)	HEIGHT	SIZE	C (MM)	HEIGHT	SIZE	
4 BASKET	300	S-1841	230 X 500MM	5 BASKET	300	S-1853	230 X 500MM
	350	S-1842	280 X 500MM		350	S-1854	280 X 500MM
	400	S-1843	330 X 500MM		400	S-1855	330 X 500MM
	450	S-1844	380 X 500MM		450	S-1856	380 X 500MM
	500	S-1845	430 X 500MM		500	S-1857	430 X 500MM
6 BASKET	HEIGHT 1850-2000MM			C=OUTSIDE CABINET SIZE			
	300	S-1865	230 X 500MM	1400MM = 55.11 INCHES			
	350	S-1866	280 X 500MM	1700MM = 66.92 INCHES			
	400	S-1867	330 X 500MM	2000MM = 78.74 INCHES			
	450	S-1868	380 X 500MM				
	500	S-1869	430 X 500MM				



SOFTCLOSING

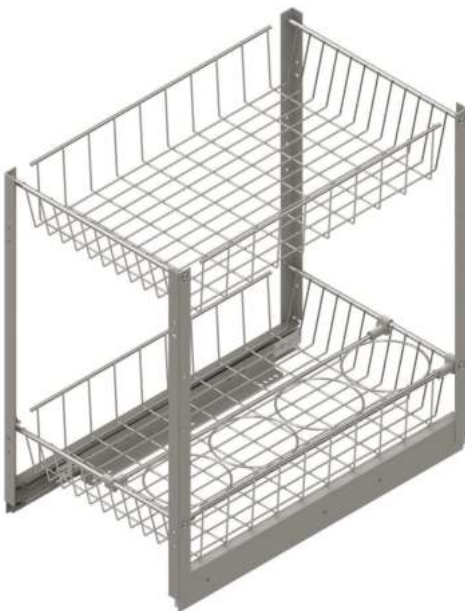

2 BASKET WITH BOTTLE HOLDER			
C (MM)	W X D X H		
300	S-2100	210 X 500 X 520	
350	S-2101	260 X 500 X 520	
450	S-2103	360 X 500 X 520	

SOFTCLOSING

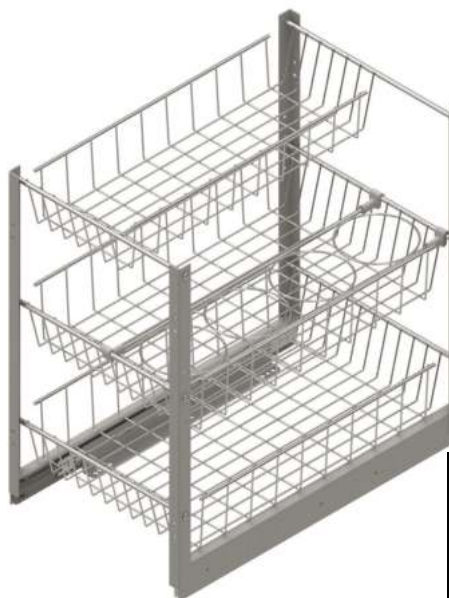

3 BASKET WITH BOTTLE HOLDER			
C (MM)	W X D X H		
300	S-2120	210 X 500 X 520	
350	S-2121	260 X 500 X 520	
400	S-2122	310 X 500 X 520	
450	S-2123	360 X 500 X 520	
600	S-2126	510 X 500 X 520	

SOFTCLOSING

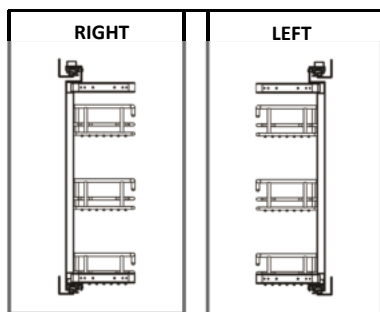
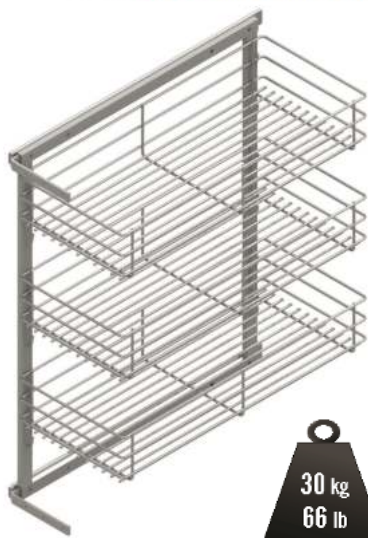

3 BASKET SIDE PULL OUT				
C (MM)	L	R	W X D X H	
250	S-2204	S-2203	205 X 470 X 635	
300	S-2205	S-2206	255 X 470 X 635	
300	S-2207	S-2208	260 X 470 X 635	

SOFTCLOSING

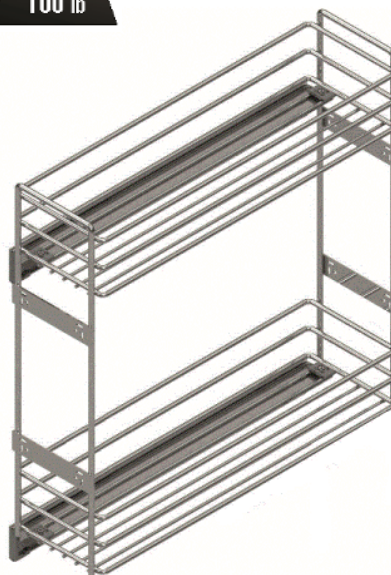

NARROW PULL OUT			
C (MM)	W X D X H		
200	S-2213	158 X 472 X 520	
250	S-2214	204 X 472 X 520	

SOFTCLOSING

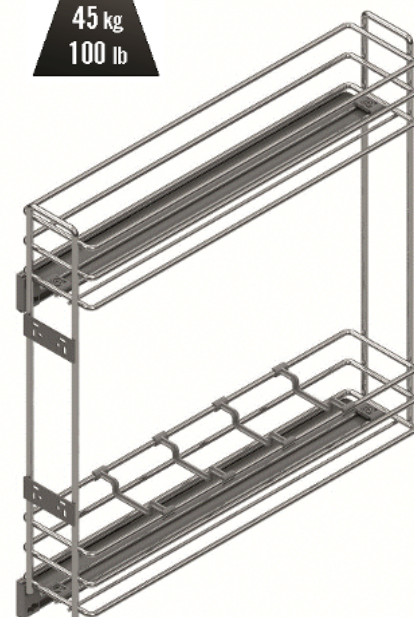

SPICE RACK & BOTTLE HOLDER			
C (MM)	W X D X H		
150	S-2211	107 X 472 X 520	

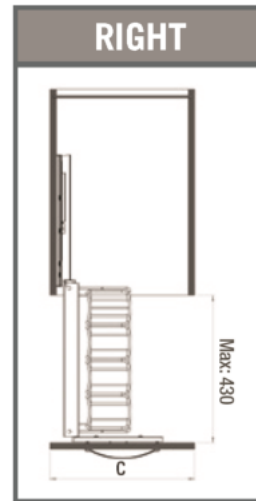
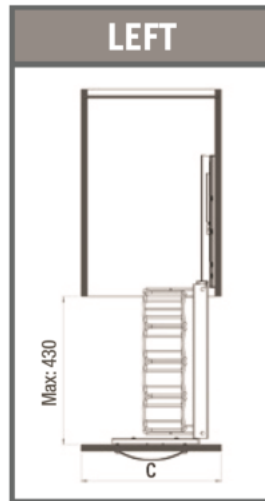

SOFTCLOSING



BOTTLE UNIT PULL OUT			
C (MM)	L	R	W X D X H
400	S-2181	S-2182	260 X 470 X 640

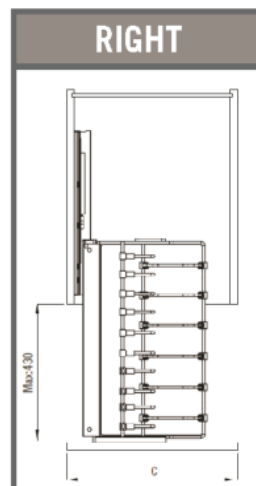
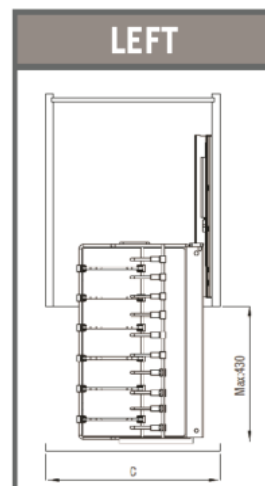

SOFTCLOSING



PAN HOLDER PULL OUT			
C (MM)	L	R	W X D X H
450	S-2880	S-2881	310 X 475 X 640

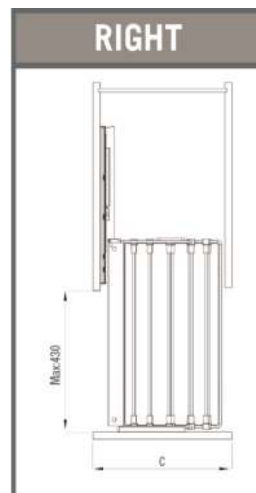
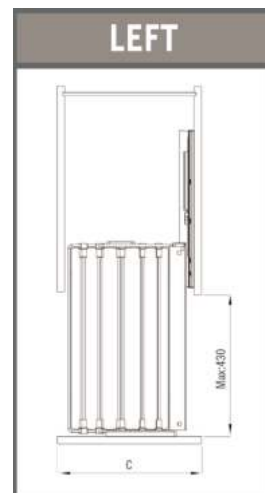

SOFTCLOSING



3 BASKET SIDE PULL OUT			
C (MM)	L	R	W X D X H
250	S-2898	S-2899	215 X 475 X 640
300	S-2894	S-2895	260 X 475 X 640
350	S-2890	S-2891	310 X 475 X 640



UNIQUE SLIM SOFT CLOSE LARDER
S-1801-US-
W=230mm x D=510mm x H=1250mm

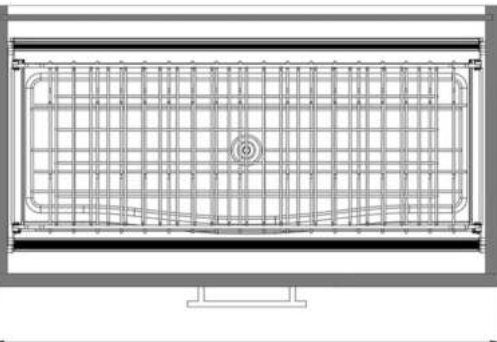
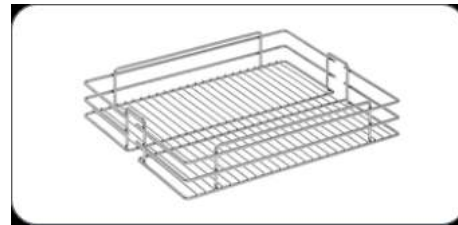
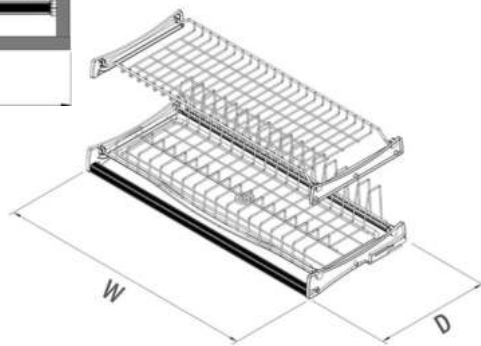
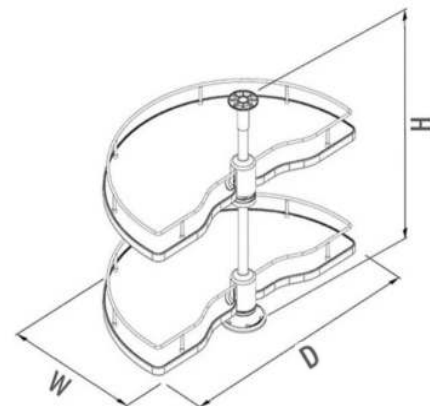
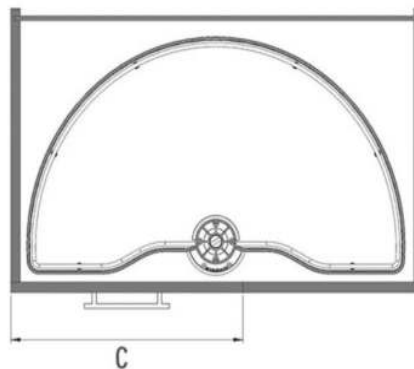

PLATE - GLASS SHELF SET
S-5159
W=560mm x D=295mm x H=345mm



TURNING BASKET SET
S-3012
W=420mm x D=650mm x





**120 kg
264 lb**



TURNING BASKET WITH RAILS
S-3041 | 800DIA X 640-760MM



**40 kg
88 lb**



3/4 TURNING BASKET ANTI SLIP
S-3052 | 750DIA X 600MM



**40 kg
88 lb**

MIN CABINET OPENING: 18"

KIDNEY "MAGIC CORNER"
W X D X H
S-3013 | LEFT 850 X 475 X 600MM
S-3014 | RIGHT 850 X 475 X 600MM



**40 kg
88 lb**

SOFTCLOSING



MIN CABINET OPENING: 18"

MAGIC CORNER
W X D X H
S-3001 | 860-965 X 530 X 530MM LEFT
S-3002 | 860-965 X 530 X 530MM RIGHT
S-3071 | 860-965 X 530 X 530MM LEFT
S-3072 | 860-965 X 530 X 530MM RIGHT



SOFTCLOSING

"MAGIC CORNER"
W X D X H
S-3067 | LEFT 700 X 510 X 560MM
S-3068 | RIGHT 700 X 510 X 560MM

**30 kg
66 lb**



**60 kg
132 lb**

WIRE KIDNEY LAZY SUSAN
S-3020 | 600DIA X 650-700MM
S-3021 | 740DIA X 650-700MM
S-3022 | 830DIA X 650-700MM



**40 kg
88 lb**

WIRE KIDNEY LAZY SUSAN
S-3011 | 740DIA X 650-700MM

HR WIRE PRODUCTS



POLISHED METAL WIRE TRAY DIVIDER

#TD-PC

BASE CABINET

CHROME

12" or 18" HEIGHT & 1/4" LENGTH

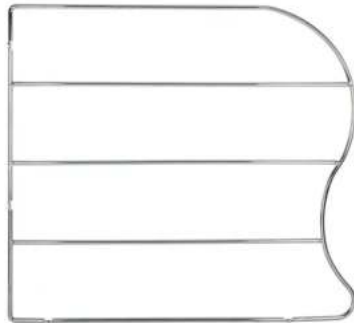

PULLOUT CANVAS HAMPER

#POHS

HEAVY DUTY WIRE FRAME

CHROME, NICKEL OR BRONZE

14" or 18" HEIGHT



SOFT CLOSED PULL OUT

#SWS-BPO5PC

BASE CABINET

CHROME or NICKEL

5 15/16" WIDTH



SOFT CLOSE BASE PULLOUT

#SWS-BPO8BN

BASE CABINET

CHROME OR BLACK NICKEL

24 1/16" HEIGHT, 8 15/16" WIDTH





PLASTIC GREY CUTLERY TRAYS							
GREY	WHITE	BLACK	SIZE	GREY	WHITE	BLACK	SIZE
S-2281			250 X 490 X 55	S-2286	S-2655		490 X 490 X 55
S-2282			300 X 490 X 55	S-2287	S-2656	S-2676	540 X 490 X 55
S-2283	S-2652		340 X 490 X 55	S-2288	S-2657	S-2677	640 X 490 X 55
S-2284	S-2653		390 X 490 X 55	S-2289	S-2658	S-2678	740 X 490 X 55
S-2285	S-2654		440 X 490 X 55	S-2290	S-2659	S-2679	840 X 490 X 55

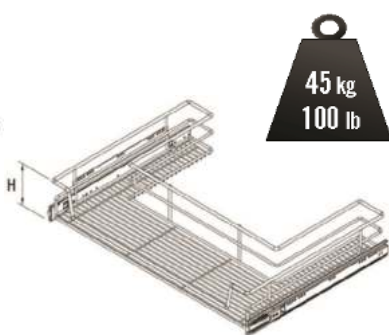
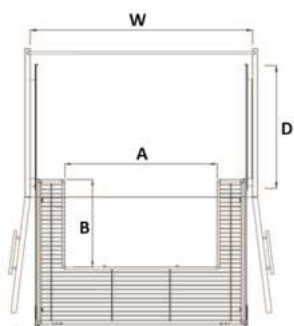

SOFTCLOSING

UNDER SINK DRAWER						
C (MM)		W	D	H	A	B
800	S-2081	762-766	500	130	525	300
900	S-2082	862-866	500	130	625	300
800	S-2351	760-780	482	130	525	300
900	S-2352	860-880	482	130	625	300

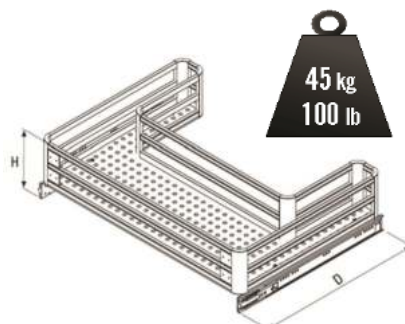
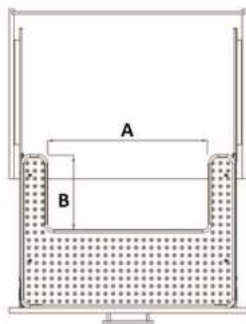

SOFTCLOSING

UNDER SINK DRAWER						
C (MM)		W	D	H	A	B
900	S-2081	864	500	150	530	310

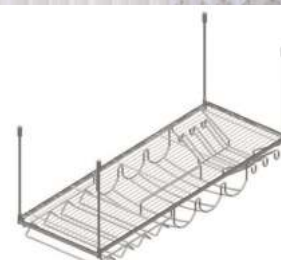
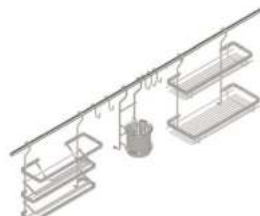

PULL DOWN SHELF WITH LIFT

S-5181	564 X 300 X 550MM
S-5183	864 X 300 X 550MM

BACKSPLASH RAIL KIT (MIDWAY SET)

S-4500	13PCS ACCESSORIES SET
--------	-----------------------

PLATE SHELF

S-5301	560-570W X 270D X 110H
--------	------------------------

HANGING MIDWAY SET

S-4111	1000W X 360D X 480H
--------	---------------------



WHITE PLASTIC LAZY SUSANS	
MP022KAR34C	24" KIDNEY
MP022KAR34D	28" KIDNEY
MP022KFN34E	32" KIDNEY
MP022RAR34A	18" ROUND
MP022RAR34C	24" ROUND
MP022RAR34D	28" ROUND

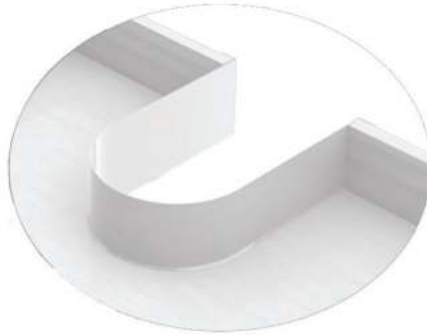

U BEND FOR UNDER SINK	
105-91-01-302	160 MMW X 245MMD x 86MMH-R80

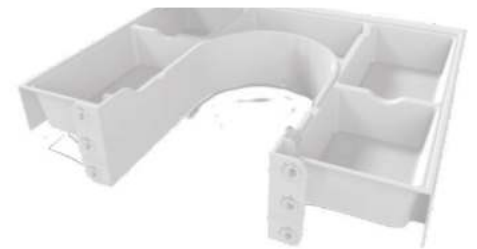

U BEND DRAIN COVER TRAY FOR 400MM CABINET	
105-91-20-302	400MMW X 322MMD X 55MMH
105-91-21-302	400MMW X 322MMD X 55MMH



TIPOUT TRAY	
WHITE	
TIPOUT-11 (2SET/BOX)	11" X 2" X 3"
TIPOUT-11S	11" X 1-9/16" X 3"
TIPOUT-14 (2SET/BOX)	14" X 2" X 3"
TIPOUT-14S (2SET/BOX)	14" X 1-9/16" X 3"



TRAY DIVIDER		
1.	TD3	11-3/4" X 22-1/4" X 16"
2.	MMTD18WHFNB	18 1/4"H X 19 3/4"D
	MMTD12WHFNA	12 1/4"H X 19 3/4"D



CUTLERY DRAWER INSERT	
DO14	14-5/8" X 22" X 1-3/4"
DO20	20-7/8" X 22" X 1-3/4"

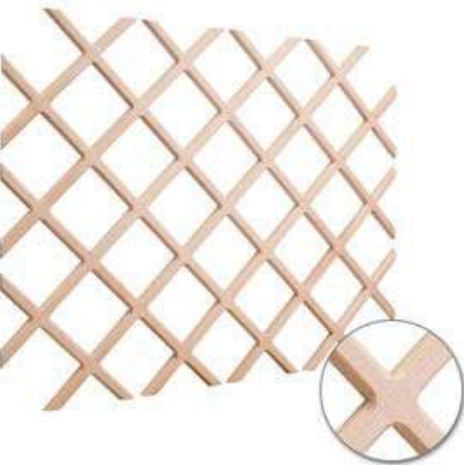

BEVELLED BOTTLE LATTICE RACK	
WR30-2	24" X 30"
WR45-2	25" X 45"
WR48-2	36" X 48"
ALDER - CHERRY - MAPLE - OAK	



SPICE TRAY DRAWER INSERTS	
SPO15	15-1/4" X 19-1/2" X 1-3/32"
SPO24	23-1/2" X 19-1/2" X 1-3/32"

SOFT CLOSING

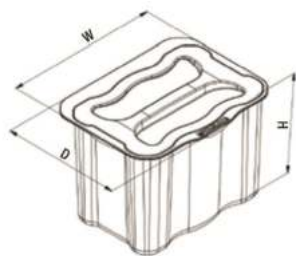

SINGLE PAIL WASTE BIN				
CODE	WIDTH	DEPTH	HEIGHT	CAPACITY
S-2575	250MM 9-13/16"	195MM 7-11/16"	180MM 7-1/16"	5L

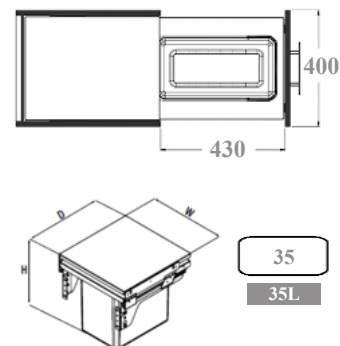

SINGLE PAIL WASTE BIN					
CODE	WIDTH	DEPTH	HEIGHT	CABINET	CAPACITY
S-2300	364MM 14-5/16"	470MM 18-1/2"	435MM 17-1/8"	40CM 15-3/4"	35L

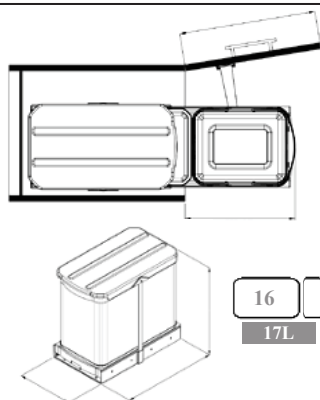

SINGLE PAIL WASTE BIN WITH EXTRA COMPARTMENT					
CODE	WIDTH	DEPTH	HEIGHT	CABINET	CAPACITY
S-2395	260MM 10-1/4"	440MM 17-5/16"	400MM 15-3/4"	40CM 15-3/4"	16L+1L

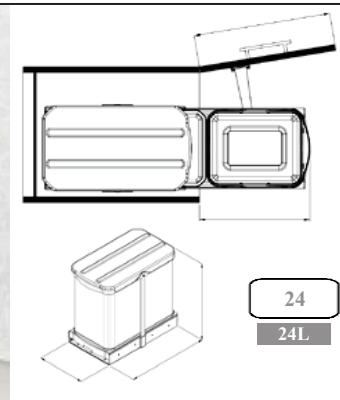

SINGLE PAIL WASTE BIN					
CODE	WIDTH	DEPTH	HEIGHT	CABINET WIDTH	CAPACITY
S-2572	260MM 10-1/4"	440MM 17-5/16"	400MM 15-3/4"	40CM 15-3/4"	24L

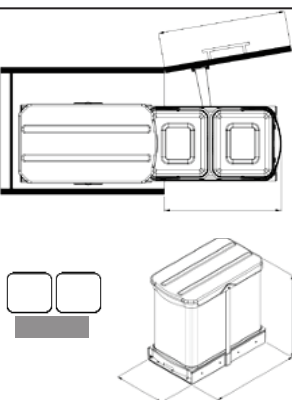

DOUBLE PAIL WASTE BIN					
CODE	WIDTH	DEPTH	HEIGHT	CABINET	CAPACITY
S-2396	260MM 10-1/4"	440MM 17-5/16"	400MM 15-3/4"	40CM 15-3/4"	2 - 12L

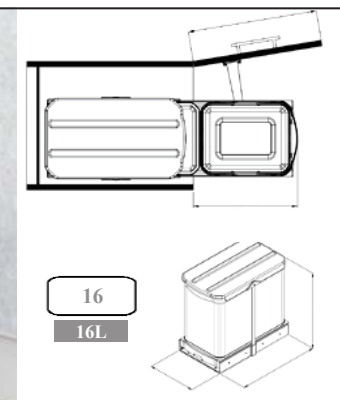

SINGLE PAIL WASTE BIN					
CODE	WIDTH	DEPTH	HEIGHT	CABINET WIDTH	CAPACITY
S-2574	260MM 10-1/4"	440MM 17-5/16"	300MM 11-3/4"	40CM 15-3/4"	16L

SOFTCLOSING

DOUBLE PAIL WASTE BIN					
CODE	WIDTH	DEPTH	HEIGHT	CABINET	CAPACITY
S-2381	364MM 14-5/16"	470MM 18-1/2"	380MM 14-15/16"	40CM 15-3/4"	12L + 12L

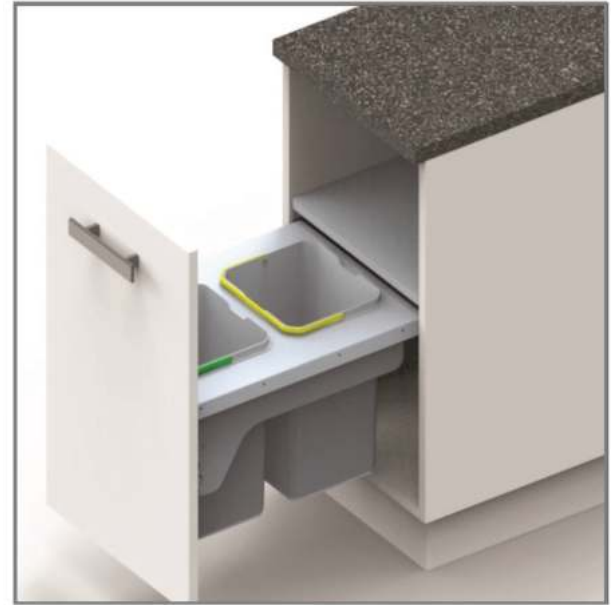
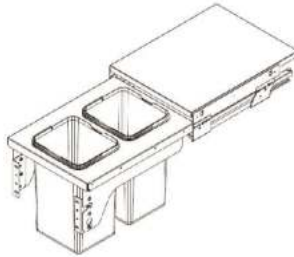
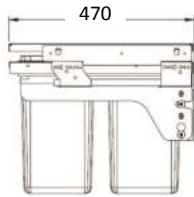
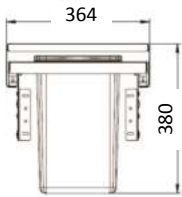

SOFTCLOSING

DOUBLE PAIL WASTE BIN					
CODE	WIDTH	DEPTH	HEIGHT	CABINET	CAPACITY
S-2382	414MM 16-5/16"	470MM 18-1/2"	380MM 14-15/16"	45CM 17-11/16"	16L + 16L

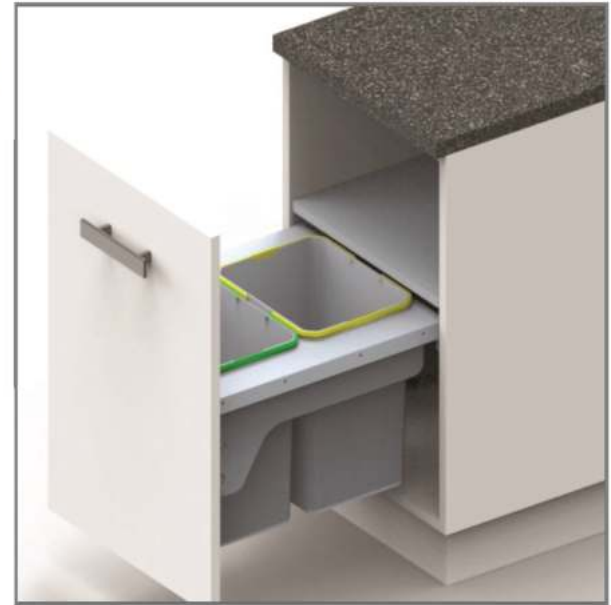
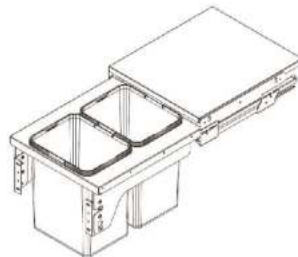
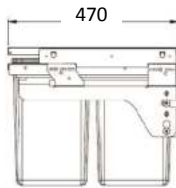
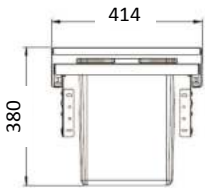

SOFTCLOSING

FOUR PAIL WASTE BIN					
CODE	WIDTH	DEPTH	HEIGHT	CABINET	CAPACITY
S-2385	564MM 22-3/16"	470MM 18-1/2"	380MM 14-15/16"	60CM 23-5/8"	16L + 12L + 12L + 1L

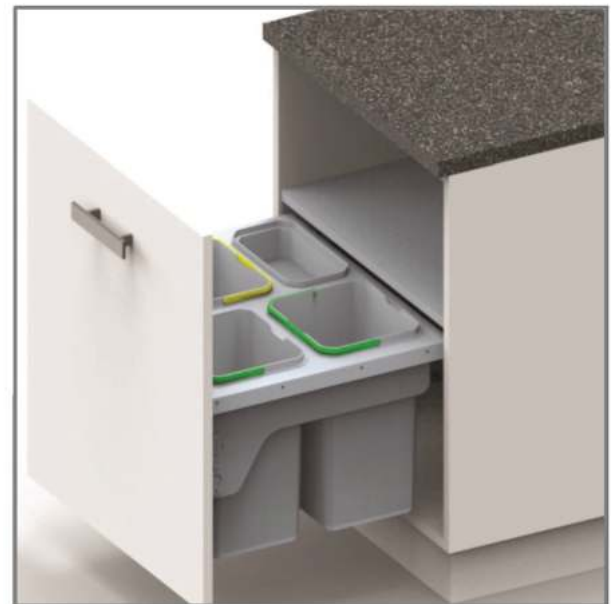
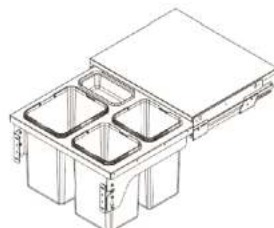

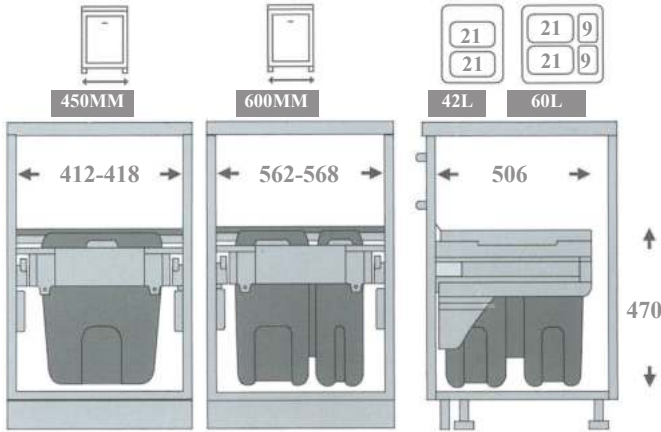

MULTI - PAIL WASTE BIN					
CODE	WIDTH	DEPTH	HEIGHT	CABINET WIDTH	CAPACITY
MB7753CM22A	412-418MM 16-1/4" - 16-1/2"	506MM 20"	470MM 18-1/2"	45MM 17-3/4"	2 - 21L
MB7753CM22D	562-568MM 22-1/8" - 22-3/8"	506MM 20"	470MM 18-1/2"	60MM 23-5/8"	2 - 21L 2 - 9L



DOOR MOUNT TRASH CAN - 10LT WHITE
MP3163DO34A | 12-1/2"W x 10-1/2"D x 12-1/2"H



DOOR MOUNT TRASH CAN - 13LT CHROME
MB1120CM25B | 11-15/16"W x 11-9/16"D x 13-11/16"H



WOOD TOP MOUNT TRASH CAN PULLOUT - 35QT		
CAN-TM35	SINGLE 35QT	11"W x 21-5/8"D x 3-1/4"H
CAN-TM35SC	SINGLE 35QT, SOFT CLOSE	11"W x 21-5/8"D x 3-1/4"H
CAN-TMD35	DOUBLE 35QT	16-1/8"W x 21-5/8"D x 3-1/4"H
CAN-TMD35SC	DOUBLE 35QT, SOFT CLOSE	16-1/8"W x 21-5/8"D x 3-1/4"H
WOOD TOP MOUNT TRASH CAN PULLOUT - 50QT		
CAN-TM50	SINGLE 50QT	11-7/8"W x 21-5/8"D x 3-1/4"H
CAN-TM50SC	SINGLE 50QT, SOFT CLOSE	11-7/8"W x 21-5/8"D x 3-1/4"H
CAN-TMD50	DOUBLE 50QT	16-1/4"W x 21-5/8"D x 3-1/4"H
CAN-TMD50SC	DOUBLE 50QT, SOFT CLOSE	16-1/4"W x 21-5/8"D x 3-1/4"H



35QT SINGLE PLASTIC TRASH CAN	
CAN-35	BLACK PLASTIC TRASH CAN
CAN-35W	WHITE PLASTIC TRASH CAN



WIRE BOTTOM MOUNT TRASH CAN PULLOUT		
CAN-35-S	SINGLE 35QT OR 50QT BLACK	10-1/4"W x 22"D x 19-1/8"H
CAN-35-SW	SINGLE 35QT OR 50QT WHITE	10-1/4"W x 22"D x 19-1/8"H
CAN-35-D	DOUBLE 35QT ONLY BLACK	14-1/2"W x 22"D x 19-1/8"H
CAN-35-DW	DOUBLE 35QT ONLY WHITE	14-1/2"W x 22"D x 19-1/8"H
DOOR MOUNTING KIT		
CAN-DOORKIT	DOOR MOUNTING KIT - BLACK	2-1/2"W x 5-1/4"D x 6-5/8"H
CAN-DOORKITW	DOOR MOUNTING KIT - WHITE	2-1/2"W x 5-1/4"D x 6-5/8"H



WOOD BOTTOM MOUNT TRASHCAN ROLLOUT
CDM-WBMD3521B
SOFT CLOSE
BLACK, GREY, OR WHITE FINISH
DOUBLE 35qt



WOOD BOTTOM MOUNT TRASHCAN ROLLOUT
CDM-WBM
SOFT CLOSE
BLACK, GREY, OR WHITE FINISH
SINGLE 35qt, 50qt. DOUBLE 35qt, 50qt

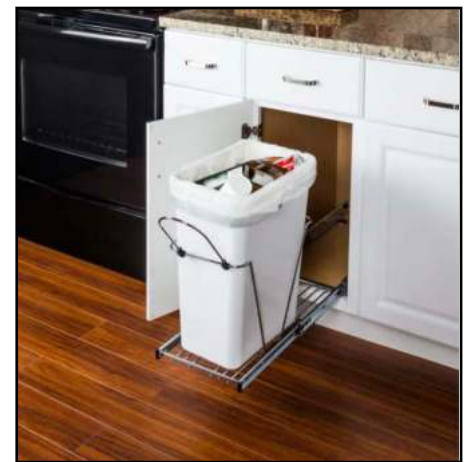

WIRE BOTTOM MOUNT TRASHCAN PULLOUT
CAN-EBMSPC-R
15" BASE / 13" HEIGHT
CHROME FINISH
SINGLE 35qt-50qt

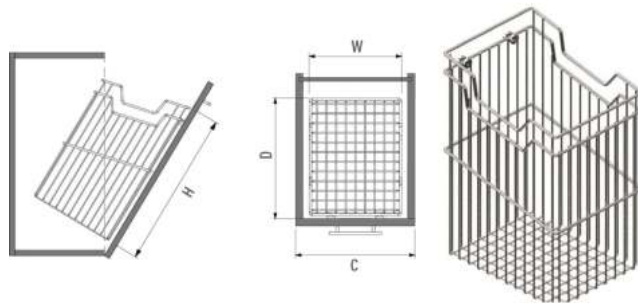
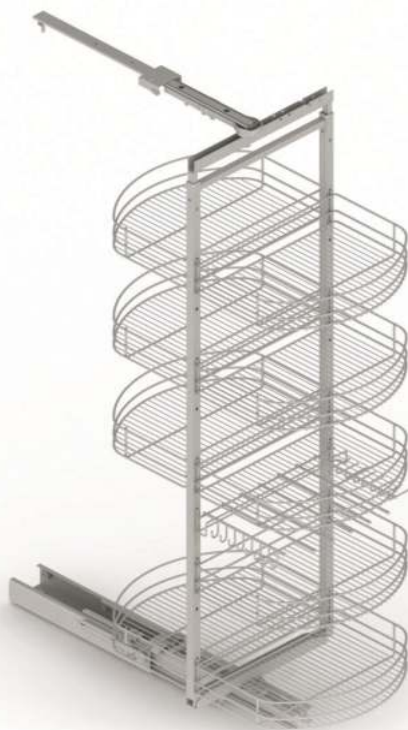

SOFTCLOSING

TURNING WARDROBE MECHANISM

C (MM)		W	D	H
900	S-6621	780MM	500MM	2000-2150

TILT OUT HAMPER UNIT

C (MM)		W	D	H
400	S-8113	330MM	290MM	500MM



LID STAYS WITH PLASTIC CAP

MB0B10LM34A	WHITE CAP
MB0B10LM03A	BROWN CAP



SHELF GALLERY

S-8601	300 X 15 X 65MM
S-8602	400 X 15 X 65MM
S-8603	500 X 15 X 65MM



SOFTCLOSING

LIFT FOR WARDROBE SUPPORTING PART

S-6018

25mm x 286mm x 114mm



TELESCOPIC WARDROBE LIFT

	W	D	H	CAPACITY
S-6013	850-1150	140MM	900MM	10KGS

PULL OUT LAUNDRY HAMPERS

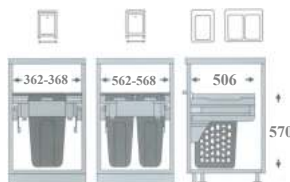

TOP MOUNT SOFT CLOSE LAUNDRY HAMPER

CODE	WIDTH	DEPTH	HEIGHT	CABINET	CAPACITY
MBLHB4CM34A	362-368MM 14-1/4" - 14-1/2"	506MM 20"	570MM 22-1/2"	40CM 15-3/4"	35L
MBLHB6CM34A	562-568MM 22-1/8" - 22-3/8"	506MM	570MM	60CM	2 - 35L

HIDEAWAY IRONING BOARD

	W	D	H
S-6611	150MM	340MM	1480MM



CASCADING TIE ORGANIZER 1-1/2" X 2-7/8" X 10-1/4"	
357T-DBAC	OIL RUB BRONZE
357T-PC	POLISHED CHROME
357T-SN	SATIN NICKEL

WIRE HANGING RAIL	
MM00HRCM17A	CHROME RAIL

VALET ROD (11")	
MM0140UL17C2	CHROME VALET ROD
MM0140UL95C2	NICKEL VALET ROD

TIE & BELT RACK (12")	
MM0140UL17D2	CHROME 14 RAILS
MM0140UL95D2	NICKEL 14 RAILS



CLOSET RODS & HOLDERS					
1	MM0880KV25A	8FT OVAL CLOSET ROD	6	MM0883KV25A	OVAL CLOSET ROD CENTER SUPPORT
2	MM0882KV25A	OVAL CLOSET ROD END CAPS WITH PINS	7	MM8793PR37A	8FT. GALVANIZED STEEL TRACK
3	MM0885KV25A	OVAL CLOSET ROD END CAPS W/OUT PINS	8	MP1981AR34A	8FT. PLASTIC WHITE COVER FOR GALV. STEEL TRACK
4	MM7009CM17A	25MM DIA. ROUND CLOSET ROD ENDS	9	MM0880KV02A	OVAL BLACK CLOSET ROD 30FT x 15FT x 8FT
5	MM1783CM17A	10FT X 1" (25MM) ROUND CLOSET ROD			

HR CLOSET ACCESSORIES



HARDWARE RESOURCES CLOSET ACCESSORIES		
1	355V	TELESCOPING VALET ROD
2	295W	12" SLIDING VALET ROD
3	295T-DBAC	BRUSHED OIL BRONZE 12" SLIDING TIE RACK

CEMUX ELECTRIC CLOSETS

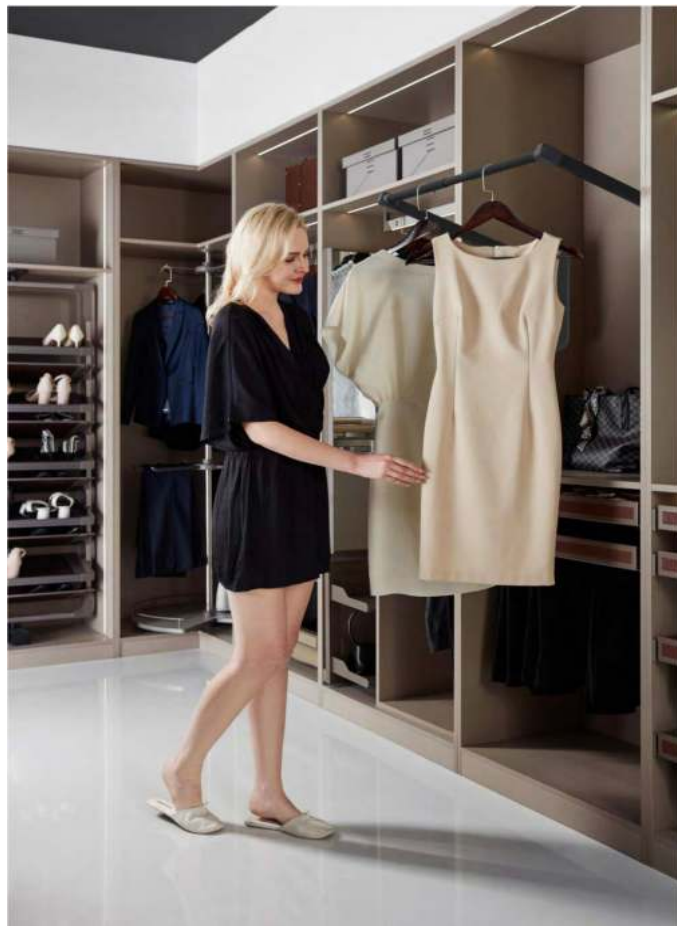

AUTOMATIC WARDROBE LIFT			
CODE	SPECIFICATION	COLOUR	WIDTH
10D04-1	(564-764)*143*823	DARK GREY	600-800mm
10D04-2	(764-964)*143*823	DARK GREY	800-1000mm
10D04-3	(964-1164)*143*823	DARK GREY	1000-1200mm



ELECTRIC SLIDING DOOR		
CODE	STANDARD WIDTH	CUTTABLE RANGE
T803A	(2050mm)	1651mm-2050mm
T803B	(2450mm)	2051mm-2450mm
T803C	(2850mm)	2451mm-2850mm



BW wardrobe system
Rotating shoe rack



- Colour: Brown
- Material: Aluminum
- Internal cabinet width: $\geq 764\text{mm}$
- Installed internal cabinet height: 1910-2110 mm; 1360-1560mm
- Installed internal cabinet depth: $\geq 382\text{ mm}$
- Package: 1 set
Frame/carton
Shoe rack/carton
Slide/carton

LW	Description	Item No.
764	Brown colour, 12 layers	BW-G503A-1
764	Brown colour, 8 layers	BW-G503B-1

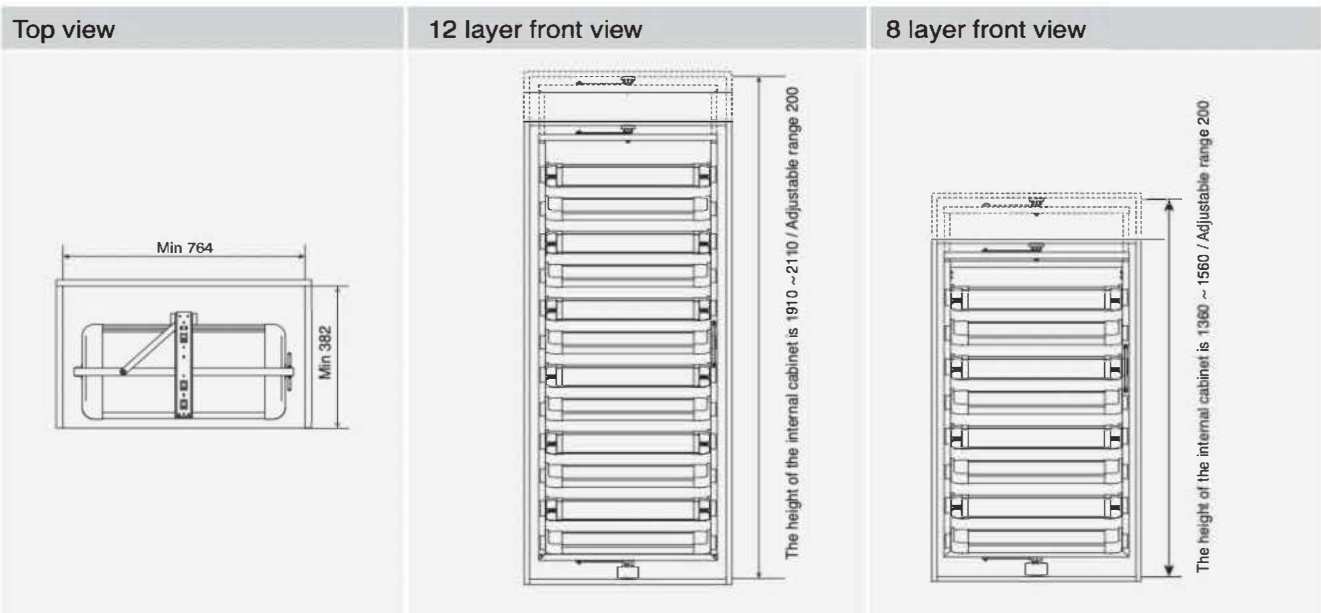

BW wardrobe system

Tie rack

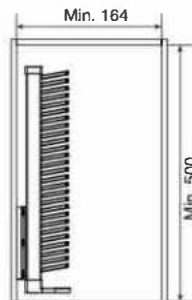

- Colour: Brown
- Material: Aluminum
- Internal cabinet width: $\geq 164\text{mm}$
- Installed internal cabinet height: $\geq 500\text{ mm}$
- Installed internal cabinet depth: $\geq 500\text{ mm}$
- Package: 1 set

LW	Description	Item No.
164	Brown colour	BW-G1305B-1

BW wardrobe system

Pull out shoe rack

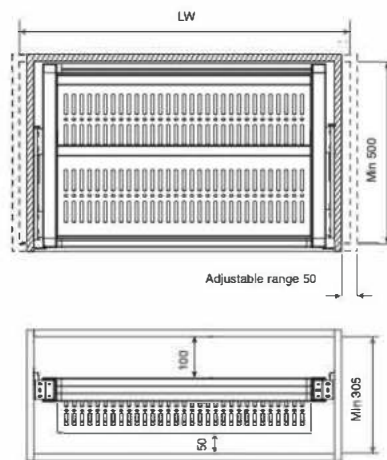

- Colour: Brown
- Material: Aluminum
- Installed internal cabinet height: $\geq 305\text{ mm}$
- Installed internal cabinet depth: $\geq 500\text{ mm}$
- Package: 1 set

LW	Description	Item No.
864-964	Brown colour	BW-G1105A-1
764-864	Brown colour	BW-G1105B-1
664-764	Brown colour	BW-G1105C-1
564-664	Brown colour	BW-G1105D-1





COMPLETE JEWELRY TRAY DRAWER SOLUTION

	5 COMPARTMENT	10 COMPARTMENT
	23-7/8"W X 14"D X 4"H	23-7/8"W X 14"D X 2"H
BLACK	JD1-24-BL	JD1-24R-BL
GREY	JD1-24-GR	JD1-24R-GR



SCREW MOUNT TIE RACKS

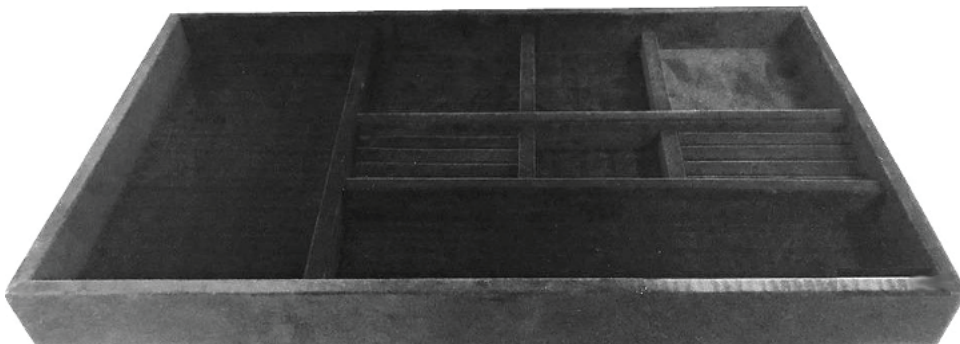

**BLACK VELVET JEWELRY TRAYS
DRAWER INSERT**

MBJTRACM02A	540 x 310 x 50mm / 21.2 x 12.2 x 1.9"
MBJTRACM02B	520 x 350 x 50mm / 20.5 x 13.8 x 1.9"
MBJTRACM02C	670 x 350 x 50mm / 26.4 x 13.8 x 1.9"
MBJTRACM02D	375 x 350 x 50mm / 14.7 x 13.8 x 1.9"



CHROME BASKET



SATIN NICKEL BASKET



DARK BRONZE BASKET



CANVAS LINER
THICK CANVAS MATERIAL WITH
VELCRO CLOSURES



PLASTIC LINER
1MM THICK OPAQUE PLASTIC

100LBS FULL EXTENSION BALL BEARING SLIDES INCLUDED
HEAVY DUTY WIRE CONSTRUCTION
RUBBER COVERS ON SLIDE HOOKS KEEP BASKET SECURELY IN PLACE BUT ALLOW EASY REMOVAL OF BASKET
CLOSED CORNERS ALLOW SMALLER ITEMS TO BE STORED WITHOUT FALLING OUT
AVAILABLE FINISHES: CHROME, DARK BRONZE, SATIN NICKEL FOR 14" AND 16" DEEP CLOSETS

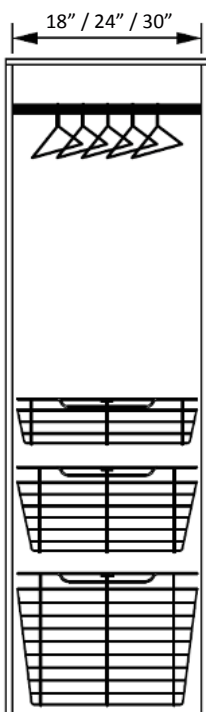

COLOR	CODE
CHROME BASKET	CH
DARK BRONZE BASKET	ORB
SATIN NICKEL BASKET	SN
CANVAS	TAN

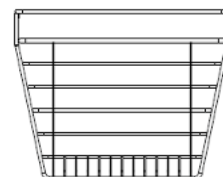
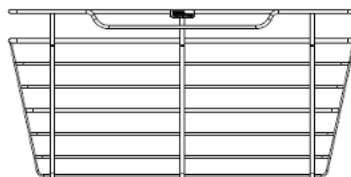

INTERIOR CABINET DIMENSION		PULLOUT BASKETS								
		18"			24"			30"		
DEPTH	TYPE	6"	11"	17"	6" H	11" H	17" H	6"	11"	17"
14"	BASKET	POB1-14176	POB1-141711	POB1-141717	POB1-14236	POB1-142311	POB1-142317	POB1-14296	POB1-142911	POB1-142917
	CANVAS	BCL-14176	BCL-141711	BCL-141717	BCL-14236	BCL-142311	BCL-142317	BCL-14296	BCL-142911	BCL-142917
	PLASTIC	POB1PL-14176	POB1PL-1417611	POB1PL-141717	POB1PL-14236	POB1PL-142311	POB1PL-142317	POB1PL-14296	POB1PL-142911	POB1PL-142917
16"	BASKET	POB1-16176	POB1-161711	POB1-161717	POB1-16236	POB1-162311	POB1-162317	POB1-16296	POB1-162911	POB1-162917
	CANVAS	BCL-16176	BCL-161711	BCL-161717	BCL-16236	BCL-162311	BCL-162317	BCL-16296	BCL-162911	BCL-162917
	PLASTIC	POB1PL-16176	POB1PL-1617611	POB1PL-161717	POB1PL-16236	POB1PL-162311	POB1PL-162317	POB1PL-16296	POB1PL-162911	POB1PL-162917



MURPHY BED	
MMSBLMCM02A	SPRING BALANCE LIFT MECHANISM
MMSBFS2CM02A	SINGLE BED FRAME WITH 13" LEGS
MMSBFD2CM02A	DOUBLE BED FRAME WITH 13" LEGS
MMSBFQ2CM02A	QUEEN BED FRAME WITH 13" LEGS
MM7700CM02A	LATERAL MOUNT EXTENSION DB BED
MM8200CM02A	LATERAL MOUNT EXTENSION QN BED

TURNING WALLBED



TURNING WALLBED	
MMFC01CM22A	QUEEN SIZE TURNING WALL BED

ECONOMIC MECHANISM



MECHANISM	
MM1081-34A	SINGLE BED WHITE MECHANISM
MM1082-34A	DOUBLE BED WHITE MECHANISM
MM1084-34A	QUEEN BED WHITE MECHANISM
STOW AWAY LEGS	
MM0400-17A	200MM (7-7/8") LEGS
MM0400-17B	250MM (9-27/32") LEGS
MM0400-17C	340MM (13-3/8") LEGS

GHOST BEDS

1



2



3



GHOST BEDS	
1.	GHOST BED
2.	GHOST SOFA BED
3.	GHOST TABLE BED

STANDING BEDS

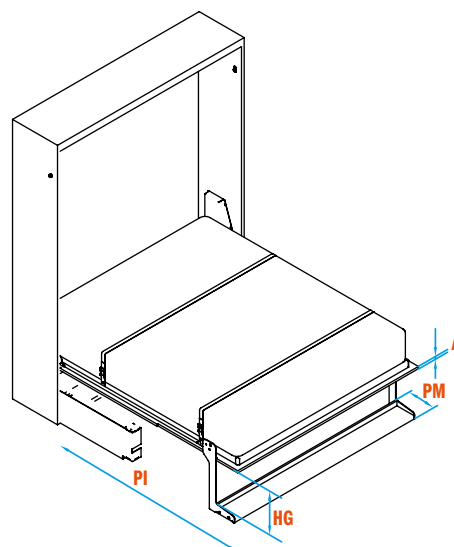

STORAGE BEDS





COMPLETE CUSTOMIZABLE PROGRAM ...

Our custom dovetail drawer boxes are available in a wide range of sizes and species making them the perfect fit for any project. Save your labor and upgrade your project with our custom dovetail drawer boxes, proudly assembled in the USA. We can also add value to your project with complimentary laser logo engraving inside the drawer boxes.

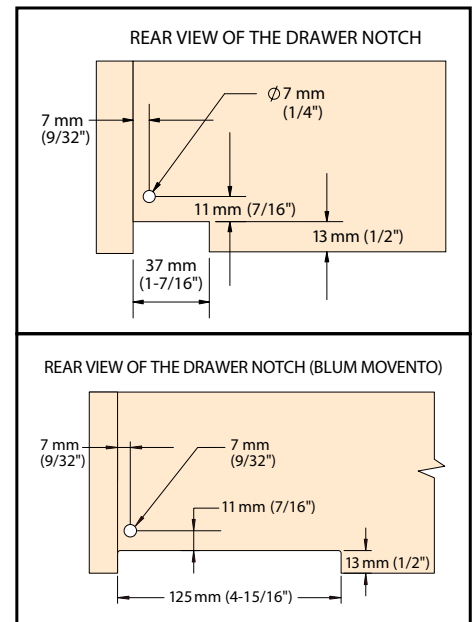

SIZING	Min. Depth	Max. Depth	Min. Width (without clips)	Max. Width	Min. Height
Standard Drawer					
5/8" Material	7"	51"	6"	51"	2"
1/2" Material	7"	51"	6"	51"	2"
Rollout Drawer					
5/8" Material	7"	51"	6"	51"	2"
1/2" Material	7"	51"	6"	51"	2"
High-Back Rollout					
5/8" Material	12"	51"	5-1/2"	51"	6"
1/2" Material	12"	51"	5-1/2"	51"	6"



RESTORATION & DECORATION





TOUCH UPS & FILLERS



ENAMELS





INTERIORS & EXTERIORS





CR.M 40

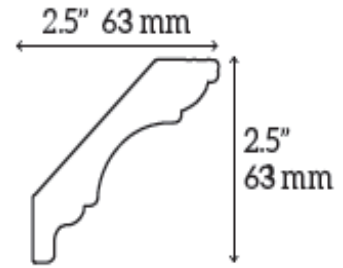

CR.M 41 41

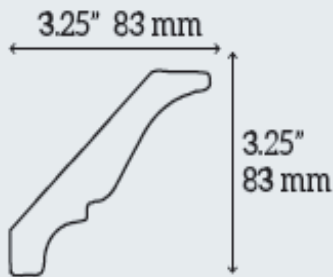

CR.M 41

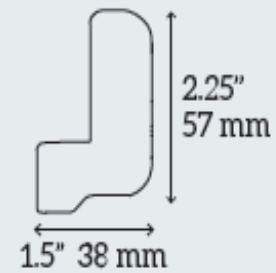

CR.M 46 46

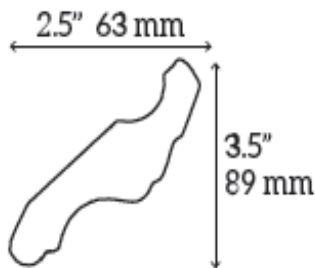

CR.M 49

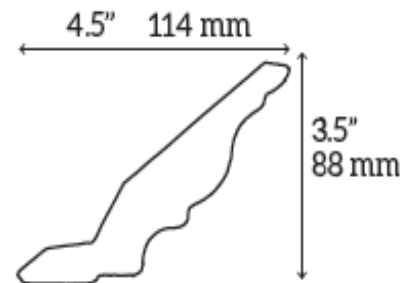

CR.M 41 50

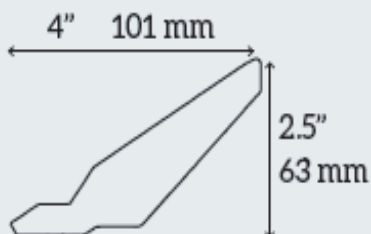

CR.M 41

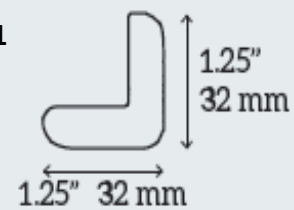

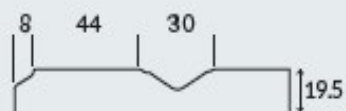
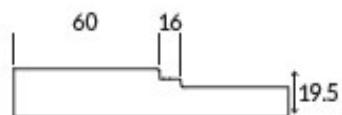
**RP-R692****RP-R700****FP-C262****FP-M477**



FP-B875

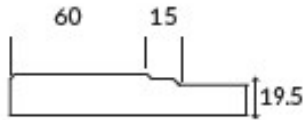

RP-P425

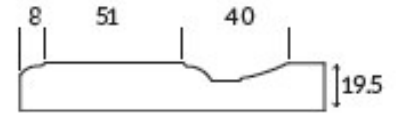

RP-M275



RP-H626

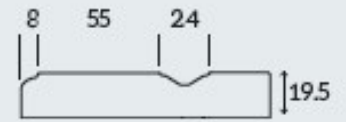

RP-H264



SL-G766

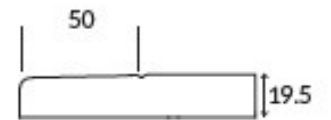

SL-S522

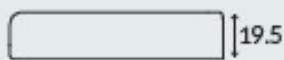

RP-A237

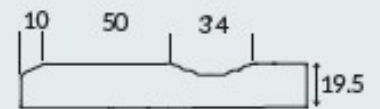



RP-G522

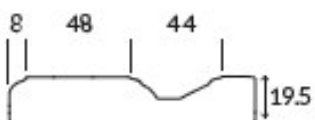

RP-M458

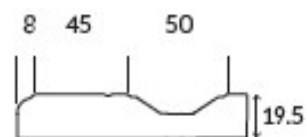

RP-P383



FP-S227



SL-D682

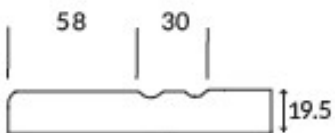

RP-S832

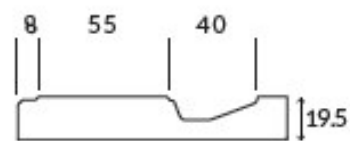

SL-P455

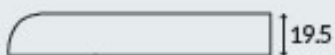

FP-V262





**SH-S353
SHAKER**



**SH-S425
SHAKER**



**SH-S425-SB
BEADED SHAKER**

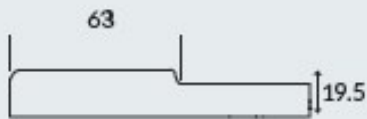

**SH-S425-VGB
V GROOVE BEADED SHAKER**

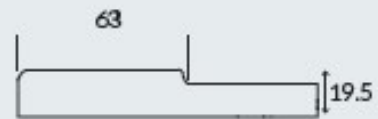

**SH-S425-VG
V GROOVE SHAKER**



RP-L297

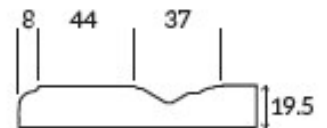

RP-B748

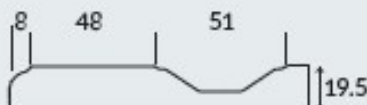

RP-G400

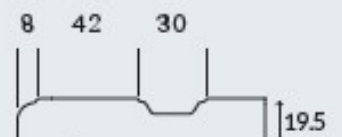



RP-R-G62

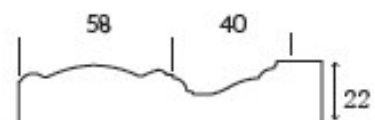

RP-R-D426



FP-R-F673

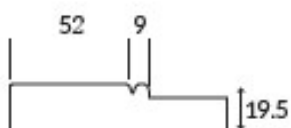

RP-R-D866

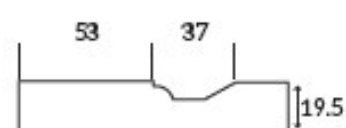

RP-R-G367



RP-R-P327





RP-R-R829

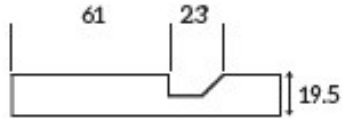

FP-R-G366

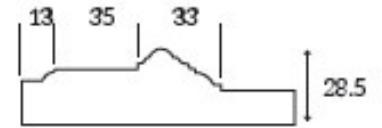

FP-R-O258



RP-R-R247



FP-R-F528

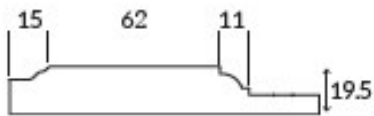

SH-R-S425



FP-R-H363



FP-R-F527

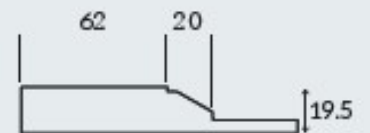

82

CA

SS



85

CA

SS



AVAILABLE IN BLACK

VERRE OPAQUE SEULEMENT
OPAQUE GLASS ONLY

87

CA

SS



88

CA

SS



89

CA

SS



AVAILABLE IN BLACK

90

CA

SS



AVAILABLE IN BLACK

ALUMINUM DOOR GLASS OPTIONS

NOUVEAU NEW AQUI (6MM)	ETRE (6MM)	KONFETTI (4MM)	NOUVEAU NEW FLUID (4MM)	M-SOFT (4MM)	AQUALITE (4MM)	CATHEDRAL (4MM)	CHINCHILLA (4-8MM)	DELTA (4MM)
CORDUROY (4MM)	DAMIER (4MM)	JUNGLE (4MM)	ACID ETCH (3-12MM)	BRONZE A/E (4MM)	GREY A/E (4MM)	CHINCHILLA B (4MM)	CLEAR FL. (3-19MM)	GLUPO (3-5MM)
LINATA (4MM)	MOSAIC (4MM)	QUATRIX S/B (4MM)	BERLINI (4MM)	FLUTEX (4MM)	GOTHIQUE (4MM)	S/B DELTA (4MM)	DIAMANTE (4MM)	LACOBEL GLASS AVAILABLE
ACID ETCHED (4MM)	SUPERLINE (4MM)	TEXTILE (4MM)	GREY FLOAT (3-6MM)	KRIZET (4MM)	SCREEN (4MM)	MIRROR (3-5MM)	MOROCCO B (4MM)	SEEDY GLASS AVAILABLE

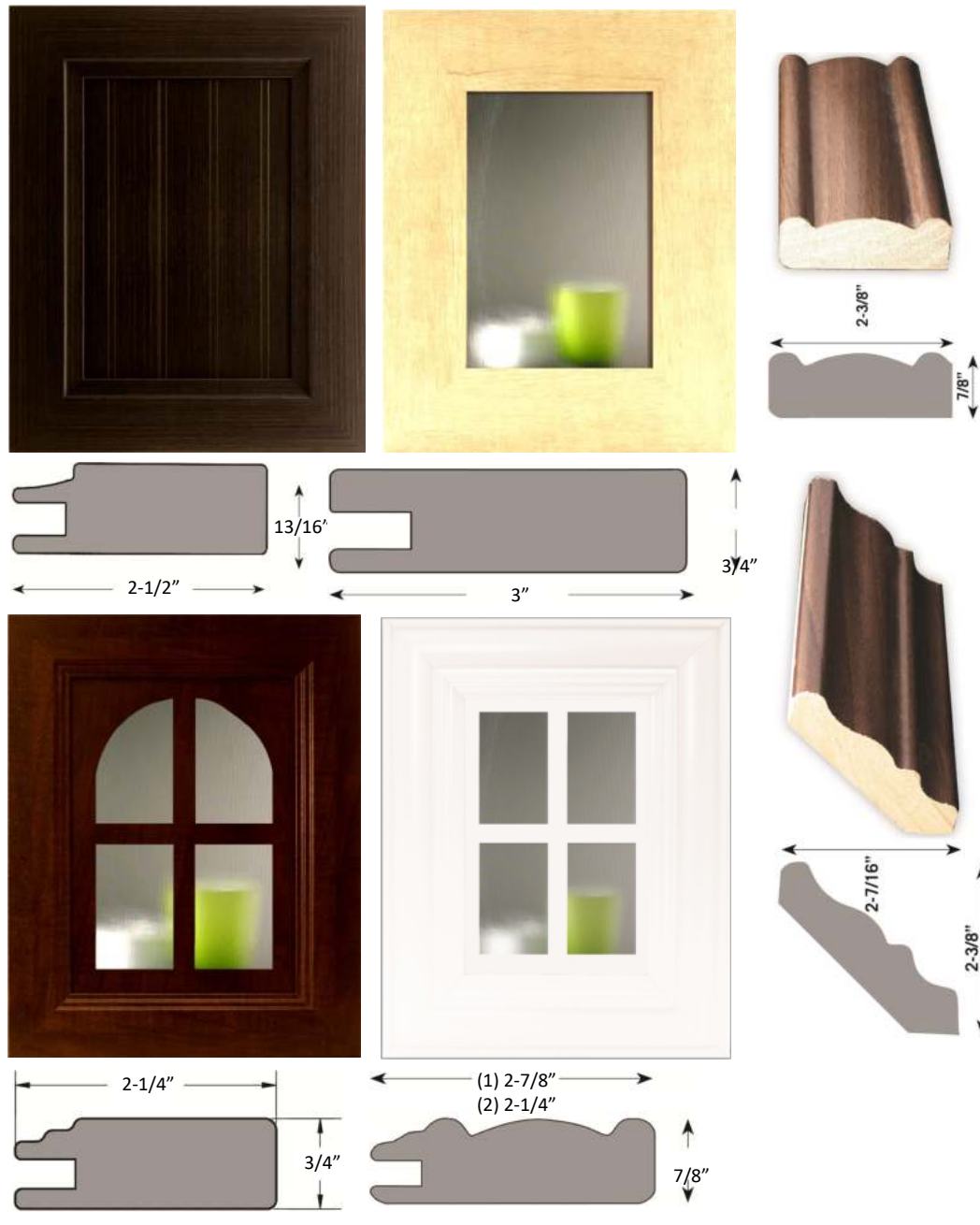

WF287/H699	
SF210/T604	
W100	
WF263/K644	
WF228(L444)	
WF294 (authentick)	
WF310 (authentick)	
WF368 (Médina)	
WF375 (Médina)	
WF202 (Médina)	
WF392 (authentick)	
WF393 (authentick)	
WF407 (Sawcut)	
WF408 (Sawcut)	
WF409 (Sawcut)	
WF242/D609	
WF116	

POLYESTER DOOR GLASS OPTIONS



ACRYLIC DOORS

1643
Proje Beyaz Project White

1548
Mürdüm Damson

1334
Metalik Gri Metallic Grey

1712
HG Açık Gri HG Light Grey

1713
Mat Açık Gri Light Grey

1532
Krem Cream

1259
Kırmızı Red

1565
Antrasit Anthracite

1537
Kaşmir Cashmere

1531
Kapuçino Cappuccino

1256
HG Siyah HG Black

1549
Bordo Bordeaux

MATT PVC DOORS

105
Siyah Black

1169
Mat Açık Ahşap Mat Light Wood

1134
Lake Kırık Beyaz Lacquered Cold White

82
İnoks Inox

1734
Premium Krom Premium Chrome

1473
Lake Beyaz Lacover White

1444
Lacivert Dark Blue

88
Krem Cream

GLASS EFFECT DOORS



1947
Glass Antrasit Glass Anthracite



1948
Glass Beyaz Glass White



1949
Glass Buzul Glass Glacier



1944
Tema Glass Mocha



1950
Glass Mercan Glass Blueatoll



1946
Glass Safari Glass Safari



1945
Glass Titan Glass Titan





COMPLETELY CUSTOM SOLUTION

HOW IT WORKS:

- SELECT YOUR PROFILE, SPECIES AND FINISH.
- TELL US ALL THE SIZES
- SHOW US WHERE YOU WANT THE DRILLING TO BE
- CONFIRM THE ORDER

THAT'S IT... TALK TO A REPRESENTATIVE FOR MORE DETAILS



WIRE MESH

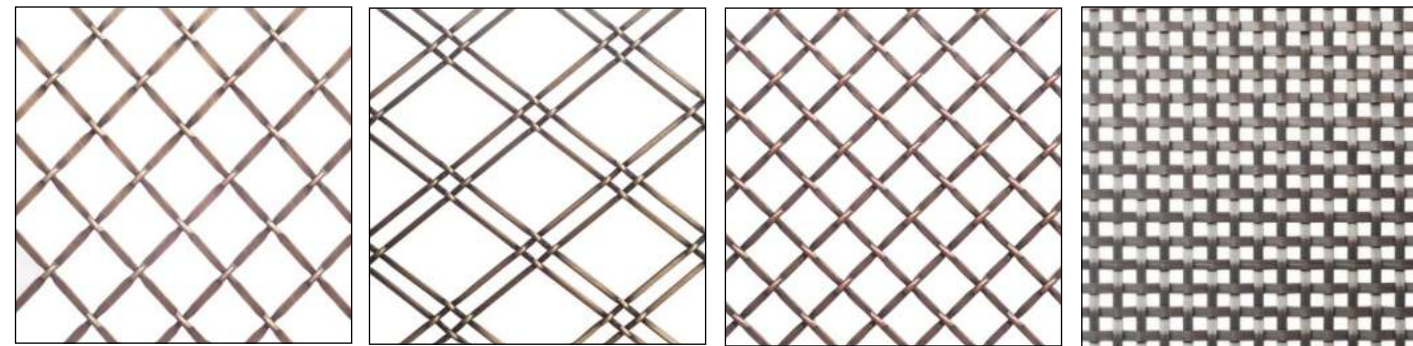

3/4" DIAMOND 36"x48"	
MM8122CM09A	ANTIQUÉ BRASS
MM8122CM43A	ANTIQUÉ COPPER
MM8122CM95A	SATIN NICKEL
MM8122CM98A	ANTIQUÉ IRON

DOUBLE DIAMOND 36"x48"	
MM8811CM09A	ANTIQUÉ BRASS
MM8811CM43A	ANTIQUÉ COOPER
MM8811CM95A	SATIN NICKEL
MM8811CM98A	ANTIQUÉ IRON

1/2" DIAMOND 36"x48"	
MM8812CM09A	ANTIQUÉ BRASS
MM8812CM43A	ANTIQUÉ COOPER
MM8812CM95A	SATIN NICKEL
MM8812CM98A	ANTIQUÉ IRON

BASKET WEAVE 36"x48"	
MM7505CM95A	SATIN NICKEL

5"X 5" SAMPLES BOXES ARE AVAILABLE FOR \$25/BOX
 CUSTOM FINISHES AVAILABLE WITH 2 WEEKS LEAD TIME. PLEASE CALL FOR DETAILS

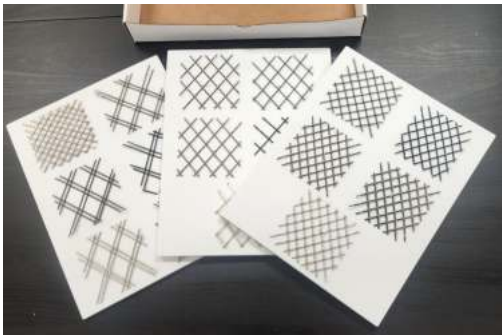



EDGE BANDING

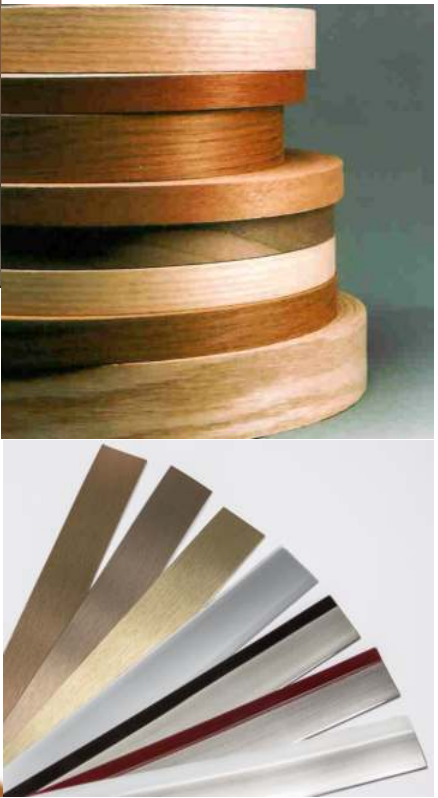

EDGE BANDING
 HUNDREDS OF COLOURS IN STOCK AND CUSTOM COLOURS ARE AVAILABLE UPON REQUEST.

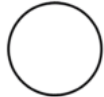

	BEECH		PEAR		MAPLE		WENGE		MAHOGANY
CODE: PC2100		CODE: PC2155		CODE: PC2110		CODE: PC2180		CODE: PC2185	
	LIGHT CHERRY		CHERRY		OAK		NATURAL OAK		WHITE OAK
CODE: PC210045		CODE: PC2146		CODE: PC2120		CODE: PC2131		CODE: PC2125	
	BIRCH		NATURAL BIRCH		DARK WAL- NUT		NEW WALNUT		ITALIAN WALNUT
CODE: PC2135		CODE: PC2140		CODE: PC2170		CODE: PC2165		CODE: PC2160	
	TEAK		DARK PINE		OLIVE		ZEBIRANO		DARK ZEBIRANO
CODE: PC2195		CODE: PC2175		CODE: PC2200		CODE: PC2206		CODE: PC2205	
	BANU		WHITE MAPLE		BAMBOO		CHERRY BASE		PEAR BASE
CODE: PC2115		CODE: PC2210		CODE: PC2230		CODE: PC2515		CODE: PC2520	
	BEECH BASE		WHITE		WHITE LAKE		MILK WHITE		CREAM
CODE: PC2525		CODE: PC2500		CODE: PC2501		CODE: PC2502		CODE: PC2507	
	BEIGE		GREY		METALLIC GREY		YELLOW		GREEN
CODE: PC2505		CODE: PC2545		CODE: PC2540		CODE: PC2530		CODE: PC2555	
	LILAK		BLUE		ORANGE		RED		BLACK
CODE: PC2565		CODE: PC2560		CODE: PC2535		CODE: PC2570		CODE: PC2510	
	GLOSSY WHITE		GLOSSY CREAM		GLOSSY RED		GLOSSY BURGUNDY		GLOSSY BLACK
CODE: PC2305		CODE: PC2310		CODE: PC2315		CODE: PC2320		CODE: PC2325	
	GLOSSY EB- ONY		GLOSSY ELM		GLOSSY WENGE		GLOSSY OLIVE		GLOSSY WALNUT
CODE: PC2330		CODE: PC2335		CODE: PC2340		CODE: PC2345		CODE: PC2350	

		50 PIECES / SHEET	50 SHEETS / PACK	40 PACKS / CARTON
Ø 14 mm				

PEEL & STICK CAPS

MELAMINE



PREGLUED MELAMINE		
EM4001DE34D1	13/16 WHITE	OTHER FINISHES AVAILABLE ALSO IN POLYESTER
EM1751CM00D	13/16 SHADOW OAK	
EM1500CM00D	13/16 HARDOCK MAPLE	

VENEERS

VENEER EDGANDING			
PREGLUED	NON-PREGLUED	SPECIES	OTHER SPECIES AVAILABLE UPON REQUEST
EW0522CM26B	EW5115PP00G	7/8 RED OAK	
EW5091PP00G	EW5095PP00G	7/8 MAPLE	
EW5210PP00G	EW5215PP00G	7/8 WHITE OAK	



CUSTOMIZATION



TOTALLY CUSTOMIZED

YOU CHOOSE SMOOTH, TEXTURED, HIGH GLOSS AND WOOD GRAIN COLORS.

YOU CAN ORDER IN THICKNESS BETWEEN 0.3MM AND 3MM.

THE WIDTH IS TOTALLY CUSTOMIZED; YOU CAN GET IT ANYWHERE FROM 13MM UP TO 610MM.

WHETHER YOU CHOOSE FROM OUR EXISTING PORTFOLIO OR ORDER A SPECIAL COLOR MATCH, WE ALWAYS TRY TO GIVE THE BEST POSSIBLE COLORMATCH ACCORDING TO THE BOARD.



LAYTEX WOOD FILLER	
MG4980	WALNUT
MG4960	LIGHT OAK
MG4950	NATURAL
MG4930	WHITE
MG442194	RED OAK

CANFILL CRAYONS



COLOURS

- WHITE / MSL175CM00A
- WHITE CHOCOLATE / MSL492CM00A
- SUMMER BREEZE / MSL540CM00A
- OFF WHITE / MS1912CM00A
- ALMOND / MSL200CM00A
- WF294 / MSW294CM00A
- GREY / MSL201CM00A
- GRAY / MSL533CM00A
- GRENADA / MSL499CM00A
- DARK GREY / MS2188CM00
- MAPLE / MS1095CM00A
- RIVIERA MAPLE / MSW140CM00A
- HARDROCK MAPLE / MSL303CM00A
- P290 / MSP290CM00A
- WF112 / MSW112CM00A
- PV838 / MS1696CM00A
- WF310 / MSW310CM00A
- L443 / MSL443CM00A
- CANDLELIGHT / MSL421CM00A
- BIRCH / MSL521CM00A
- OAK / MSP205CM00A
- SUMMERFLAME / MSL420CM00A
- L473 / MSL473CM00A
- D608 / MS1068CM00A
- RED BROWN / MSP965CM00A
- PASSION / MSL422CM00A
- WF116 / MS1851CM00A
- L449 / MSL449CM00A
- DARK BROWN / MSL440CM00A
- GLOSSY DARK BROWN / MSL444CM00A
- SPRING BLOSSOM / MSL543CM00A
- TUXEDO / MSL477CM00A
- WF202 / MSW202CM00A
- BLACK / MSL203CM00A
- BLACK MAGIC / MSL487CM00A

CUSTOM COLOURS AVAILABLE

OUR CANFILL CRAYONS MATCH SEVERAL BOARD MANUFACTURES, INCLUDING BUT NOT LIMITED TO: ARAUCO, PANVAL, UNIBOARD AND MORE. IF YOU HAVE ANY QUESTIONS OR ARE NOT SURE OF A MATCH PLEASE CALL US AND WE CAN HELP.

LED Lighting and Power for any space

LED Linear Fixtures | LED Tape Lighting | LED Tape Lighting Kits | Specialty Lighting
Lighted Power Strip Fixtures | Angle Power Strip Fixtures



TASKTM
lighting & power

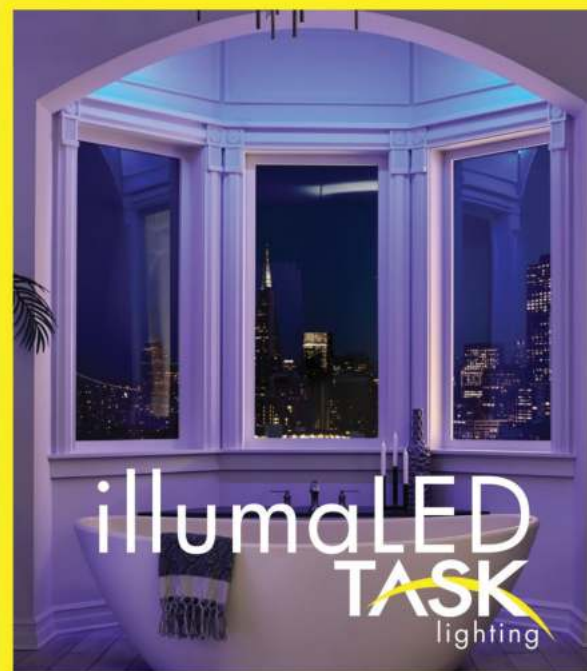

POWER AND LIGHTING SOLUTIONS / CUSTOM PLANNING AVAILABLE

Design Services Sample Layouts

Sample layout showing RGB Lighting, Tunable-White Lighting, and Angle Power Strip Fixtures



Design Services
866-848-9094
DesignAndSupport@tasklighting.com

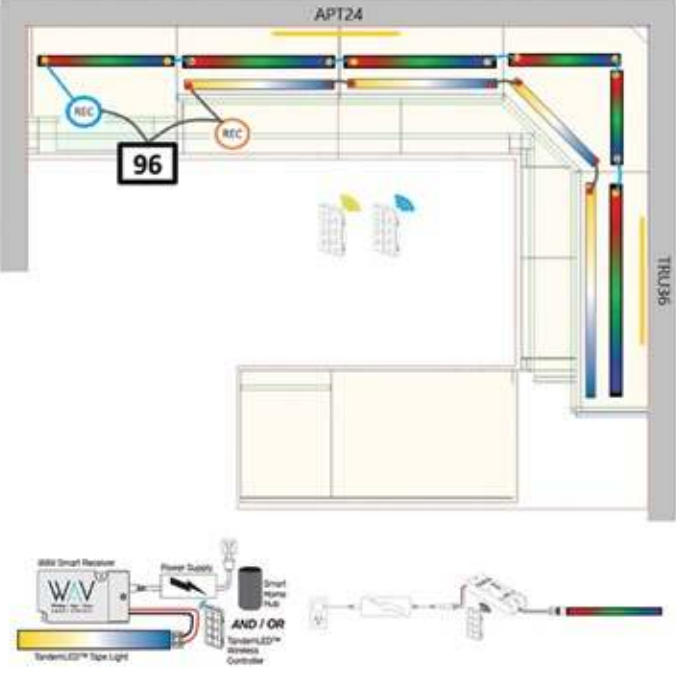

QUANTITY	SYMBOL	ITEM NUMBER	
1		L-TRUB-15-ANW 24" 1/2" Tandem Series LED Tape Light	
2		L-6MM-428PW-W Tape Light to wire connector (2 are included in kit)	
1		L-007-PK-48 48" 207 series flat housing. Recast brass	
1		L-007-PK-30 30" 207 series flat housing. Recast brass	
10		L-AC-007 Mounting clip, 207 series housing	
1		L-RGB-MISS-14 36" 1/2" roll RGB color-changing LED tape light	
10		L-6MM-488-WSC RGB tape light to wire connector	
2		L-APU-4258 3M Adhesive Promoter Wipes	
1		T-96W-12V-PH 96 watt plug-in power supply	
1		T-TRUB-WR-120 WR Smart Receiver	
1		T-3WAY-WR120-RGB WR Smart Receiver for 4 wire RGB lighting	
1		T-CW-200-STR-25 20 gauge stranded, ultra jacket, 25' roll	
20		L-RGB-4C-WIRE RGB 4-wire connector wire	
1		T-12-12V-PP-WT Tandem 12 volt wire 12 feet, white	
1		T-C-RGBWC-R-WT RGB control wire	
1		APT24-40-P-2H 24" slim profile angle power strip	
1		TRU36-250-P-BS 36" 250 Series Angle Power Strip with ultra durable, white finish	

Layout sent to customer by Design Services suggesting lighting and power products and installation locations



Design Services
866-848-9094
DesignAndSupport@tasklighting.com

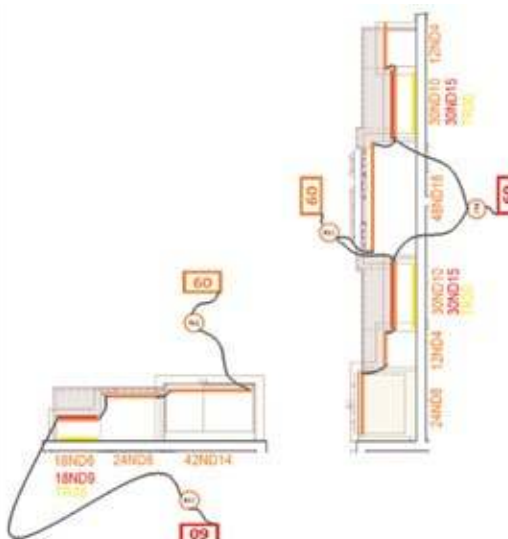

Wiring is based upon job site conditions. Additional power supplies & receivers may be needed based upon areas required and zones needed.

QUANTITY	SYMBOL	ITEM NUMBER	
1		L-6MM-428PW-W Tape Light to wire connector (2 are included in kit)	
1		L-6MM-428PW-W Tape Light to wire connector (2 are included in kit)	
1		L-007-PK-48 48" 207 series flat housing. Recast brass	
1		L-007-PK-30 30" 207 series flat housing. Recast brass	
10		L-AC-007 Mounting clip, 207 series housing	
1		L-RGB-MISS-14 36" 1/2" roll RGB color-changing LED tape light	
10		L-6MM-488-WSC RGB tape light to wire connector	
2		L-APU-4258 3M Adhesive Promoter Wipes	
1		T-96W-12V-PH 96 watt plug-in power supply	
1		T-TRUB-WR-120 WR Smart Receiver	
1		T-3WAY-WR120-RGB WR Smart Receiver for 4 wire RGB lighting	
1		T-CW-200-STR-25 20 gauge stranded, ultra jacket, 25' roll	
20		L-RGB-4C-WIRE RGB 4-wire connector wire	
1		T-12-12V-PP-WT Tandem 12 volt wire 12 feet, white	
1		T-C-RGBWC-R-WT RGB control wire	
1		APT24-40-P-2H 24" slim profile angle power strip	
1		TRU36-250-P-BS 36" 250 Series Angle Power Strip with ultra durable, white finish	



Final installation photo based on layout by Design Services

Design Services

Technical Support and Free Layout

Receive a Lighting Quote in 3 easy steps



Complete

The Customer Quote Form that can be found by scanning the QR code



Attach

Your floor plans or elevations with dimensions



Email

DesignAndSupport@TaskLighting.com to receive a FREE layout and quote

The form includes fields for Name, Job Name, Date Received By, Order Number, and Order No. It also has sections for 'TYPE OF PROJECT', 'TYPE OF LIGHTING', 'SELECT RELAY TEMPERATURE', 'TYPE OF POWER SUPPLY', and 'SELECT ANGLE POWER STRIP SERIES'.

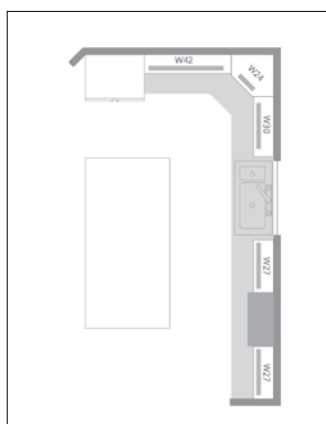

The form is shown with a floor plan diagram overlaid on it, illustrating the process of attaching the floor plan to the quote form.

Don't know where to start?

Do you have more questions before completing and submitting your quote form? Call **866-848-9094** or email DesignAndSupport@TaskLighting.com. Get connected with one of our friendly in-house Design Services team members to help you pick out the lighting products that will work best in the space.

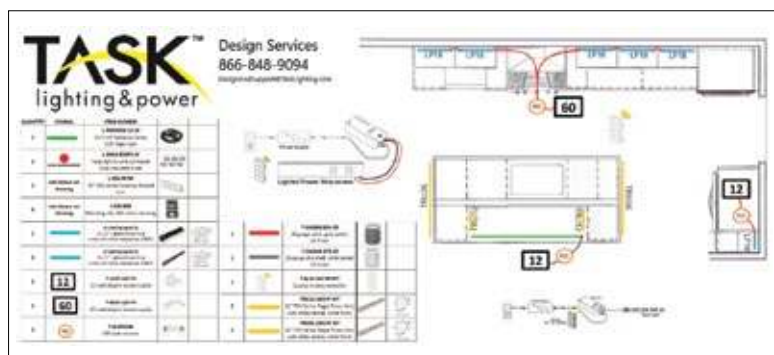

Sample layout from Design Services showing Lighted Power Strip and Angle Power Strip fixtures

Design Services Sample Layouts

Sample layout showing Tunable-White Lighting and Angle Power Strip Fixtures



Design Services
866-848-9094
DesignAndSupport@TaskLighting.com

QUANTITY	SYMBOL	ITEM NUMBER	DESCRIPTION	UNIT
4	[Symbol]	CTPT12V18-8W	12" FT Series Angle Power Strip with white deck, white finish	
4	[Symbol]	CTPT12V18-8W	12" FT Series Angle Power Strip with white deck, white finish	
4	[Symbol]	CTPT12V18-8W	12" FT Series Angle Power Strip with white deck, white finish	
4	[Symbol]	CTPT12V18-8W	12" FT Series Angle Power Strip with white deck, white finish	
1	[Symbol]	T-FAS-60W-PWR	60W Adjustable 60 Watt Power Supply / Receiver	
1	[Symbol]	F-CK200-07R-80	80 gauge aluminum, white, 20" x 80" x 1/2"	
1	[Symbol]	T-12-12-40-AS-80T	Transformer, 120V primary & 12V secondary, 80W	
4	[Symbol]	TRU240-P-INT	24" FT Series Angle Power Strip with white deck, white finish	
4	[Symbol]	TRU240-P-INT	24" FT Series Angle Power Strip with white deck, white finish	
4	[Symbol]	TRU240-P-INT	24" FT Series Angle Power Strip with white deck, white finish	
4	[Symbol]	TRU240-P-INT	24" FT Series Angle Power Strip with white deck, white finish	

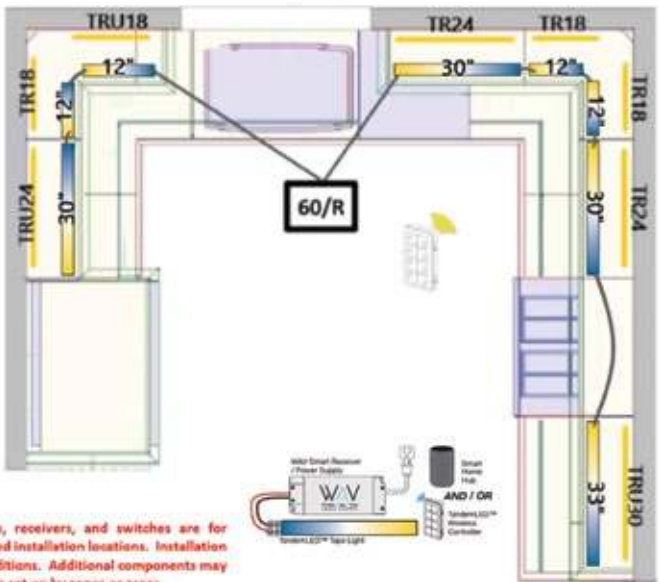

Locations of wiring, power supplies, receivers, and switches are for illustration and do not indicate required installation locations. Installation locations are based upon job site conditions. Additional components may be needed when wireless controlling is set up by zones or areas.



Design Services
866-848-9094
DesignAndSupport@TaskLighting.com

QUANTITY	SYMBOL	ITEM NUMBER	DESCRIPTION	UNIT
1	[Symbol]	W-12-12-40-AS-80T	Transformer, 120V primary & 12V secondary, 80W	
1	[Symbol]	T-FAS-60W-PWR	60W Adjustable 60 Watt Power Supply / Receiver	
1	[Symbol]	F-CK200-07R-80	80 gauge aluminum, white, 20" x 80" x 1/2"	
4	[Symbol]	TRU240-P-INT	24" FT Series Angle Power Strip with white deck, white finish	
4	[Symbol]	TRU240-P-INT	24" FT Series Angle Power Strip with white deck, white finish	
4	[Symbol]	TRU240-P-INT	24" FT Series Angle Power Strip with white deck, white finish	
4	[Symbol]	TRU240-P-INT	24" FT Series Angle Power Strip with white deck, white finish	



Wiring is based upon job site conditions. Additional power supplies & receivers may be needed based upon area required and zones needed.

Layout sent to customer by Design Services suggesting lighting and power products and installation locations

Final installation photo based on layout by Design Services





DESIGN SERVICES

Free design and technical support assistance every step of the way. Call us at 866-848-9094 or email DesignAndSupport@TaskLighting.com

Selection of light color

Help selecting the best Kelvin temperature for your space or choosing any Kelvin temperature 2700K–5000K with our tunable-white lighting



Warm White 2700K

Soft White 3000K

Cool White 4000K

Daylight White 5000K

Selection of Controller

Assistance in deciding what controller works best for your lighting design

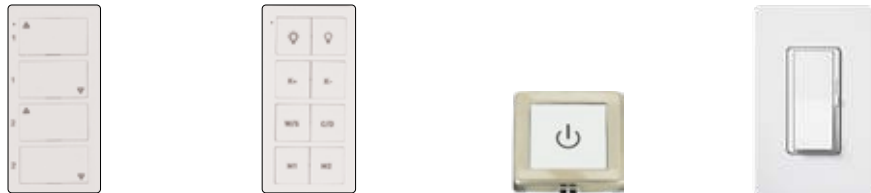

Two Zone Controller
T-Q-2Z-WC-RF-WT

Tunable-White Controller
T-T-1Z-WC-RF-WT

Touch Dimmer
T-TDS-60W

Hardwired Dimmer
DVLV-600P-WT

Layout and Product Recommendations

Layout recommendations for the best lighting and power locations with a suggested products list included

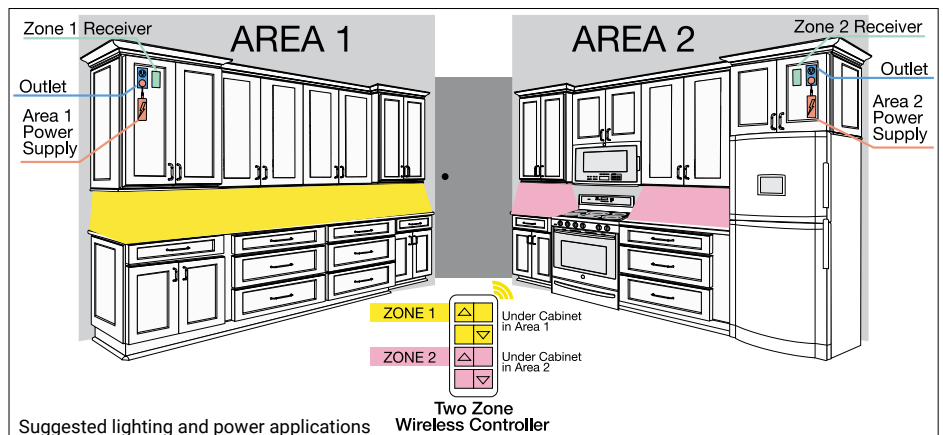



ANGLE POWER STRIP
TR SERIES



ANGLE POWER STRIP
TR-USB SERIES



ANGLE POWER STRIP
APT SERIES



ANGLE POWER STRIP
SELECTION GUIDE



LIGHTED POWER STRIP
DV SERIES
414 LUMENS PER FOOT



LIGHTED POWER STRIP
RM SERIES
540 LUMENS PER FOOT



LIGHTED POWER STRIP
SELECTION GUIDE



TAPE LIGHT
VIVID SERIES
225 LUMENS PER FOOT



TAPE LIGHT
RADIANCE SERIES
120 LUMENS PER FOOT



TAPE LIGHT
DRIZZLE SERIES
49 LUMENS PER FOOT



TAPE LIGHT KITS
VIVID & RADIANCE SERIES



TAPE LIGHT
RAGE SERIES
466 LUMENS PER FOOT



TAPE LIGHT
SIDE VIEW SERIES
126 LUMENS PER FOOT



PUCK LIGHT
PEARL SERIES
205 LUMENS



PUCK LIGHT
VIVID ULTRA THIN SERIES
190 LUMENS



PUCK LIGHT
MINI ROUND SERIES
105 LUMENS



PUCK LIGHT
MINI SQUARE SERIES
105 LUMENS



RETRO FIT
CAN LIGHTS
900 LUMENS



ILLUMATED
ACCESSORIES



TASK LIGHTING
ACCESSORIES



TAPE LIGHT
RGB INFERNO SERIES
260 LUMENS PER FOOT



STRIP LIGHT FIXTURE
SG9 SERIES
540 LUMENS PER FOOT



MINI STRIP LIGHT FIXTURE
F SERIES
414 LUMENS PER FOOT



MINI ANGLED STRIP LIGHT
FIXTURE A SERIES
414 LUMENS PER FOOT



ANGLED STRIP LIGHT
FIXTURE S SERIES
540 LUMENS PER FOOT



RECESSED STRIP LIGHT
FIXTURE R SERIES
540 LUMENS PER FOOT



120V BAR LIGHT FIXTURE
432 LUMENS PER FOOT



LIGHTED CLOSET
ROD FIXTURE
414 LUMENS PER FOOT



SEMPRIALED
ACCESSORIES



LED SWIVEL TASK LIGHTING		
LMTL24CM34A	24" (620MM X 90MM X 28MM) / 14W	WITH ON/OFF SWITCH 1.5M POWER CORD
LMTL36CM34A	36" (920MM X 90MM X 28MM) / 21W	
LMTL48CM34A	48" (1220MM X 90MM X 28MM) / 28W	
CAN INSTAL WITH SCREWS, DOUBLE SIDED TAPE OR BY MAGNETIC STRIP		



LUMENS OUTPUT LED TAPE LIGHT

L-VMW600
12V VOLTAGE
16 FEET
8MM WIDTH



LUMENS OUTPUT LED TAPE LIGHT

L-RMW300
12V VOLTAGE
32 FEET
8MM WIDTH



LUMENS OUTPUT LED TAPE LIGHT

L-V600-100
12V VOLTAGE
100 FEET
8MM WIDTH



LUMENS SIDE VIEW OUTPUT LED TAPE LIGHT

L-SV300-16
12V VOLTAGE
16 FEET
8MM WIDTH



LED STRIP LIGHTING	
LM12FLX	120° BEAM ANGLE COOL WHITE AND WARM WHITE DC12V

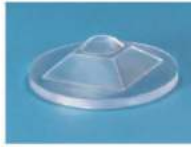
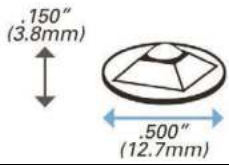

MPBS33BS15A	CLEAR	200PCS / SHEET 5,000PCS / BOX
-------------	-------	----------------------------------

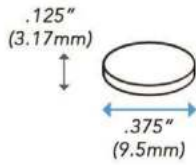

MF0001EF56A	BROWN	6,000PCS / ROLL
-------------	-------	-----------------

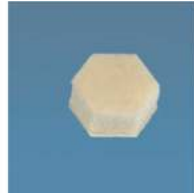
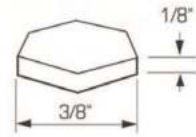

MZ0729CF34A	WHITE	203PCS / SHEET
-------------	-------	----------------



CORNER BRACKET
MMCSO993CM31A



CORNER BRACKET
MBCS1006CM31A

16" STEEL DRAWER SUPPORT
MMCS802CM31A

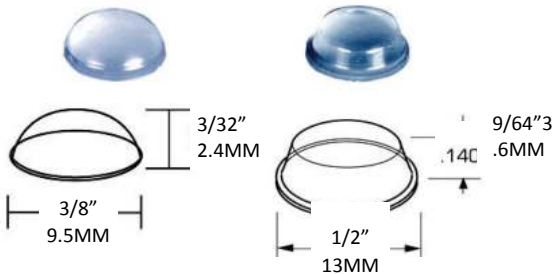

BUMPERS		
MR0005NP15B	CLEAR	288PCS / SHEET 7200PCS / BOX
MR0005EF15C	CLEAR	200PCS / SHEET 5000PCS / BOX



GLASS RETAINER	
MP1352YP05A	BROWN NOTCHED GLASS RETAINER
MP1352YP15A	CLEAR NOTCHED GLASS RETAINER
MP1352YP34A	WHITE NOTCHED GLASS RETAINER



LAMELLO BISCUITS	
MW0310ES24A	1" X 2 3/8" GR20



WOODEN DOWELSS	
MW5013SS57A	8X30
MW830GSB57A1	8X30 PREGLUED
MW5013SS57C	8X35
MW835GSB57A	8X35 PREGLUED
MW5013SS57C	8X40

OTHER SIZES AVAILABLE UPON REQUEST



"T" AND INSERT NUTS FOR GLIDES	
1	MM6856AF31T "T" NUT, 5/16-18 THREAD, WITH PRONGS
2	MM0737LC37A INSERT NUT, 5/16-18 THREAD



PLASTIC WEDGES AND GLIDES	
MP0048SC03A	BROWN STRIP GLIDE



GLIDES	
MP0049SC34B	WHITE NAIL GLIDE WITH 5/8 NAIL



THREADED GLIDES	
MB9250SC02A	5/16, BLACK LEVELER, 25MM(D) X 42MM



GLIDE AND NUT COMBO	
MB0400BA02A	5/16"-18 PROPEL NUT



FURNITURE TIPPING RESTRAINT KIT	
MBATIPCM00A	CONTENT:
	<ul style="list-style-type: none"> • 1 ZIP TIE • 1 ANCHOR • 2 BRACKETS • 2 SCREWS • 1 FOR WALL ANCHOR • 1 FOR FURNITURE
	PACKAGING INCLUDES:
	<ul style="list-style-type: none"> • INSTRUCTIONS • WARNING DETAILS IN: <ul style="list-style-type: none"> • ENGLISH • FRENCH • SPANISH

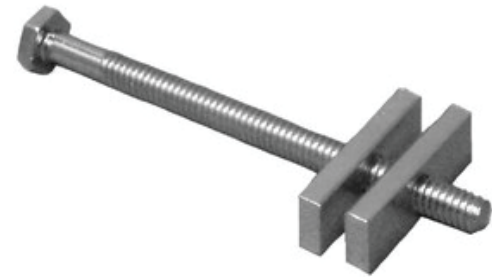

COUNTERTOP BOLT	
MM0003WT37B	3-1/2" COUNTERTOP BOLT

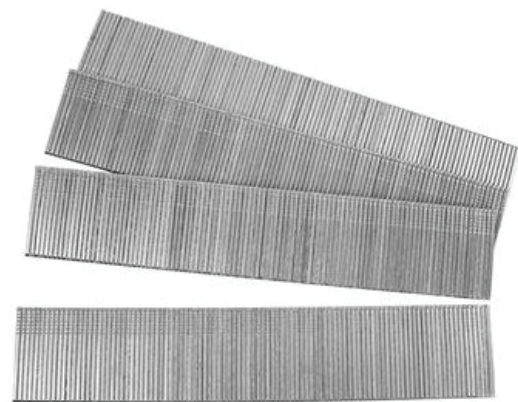

TABLE ACCESSORIES	
MP8007LC03A	PLASTIC TABLE-TOP LEVELLER



YELLOW COATED STAPLES	
1002	16 GAUGE 7/16" CROWN X 2" LONG

ADDITIONAL SIZES AVAILABLE



BRAD NAILS	
181	18 GAUGE 1" BRAD NAIL
18112	18 GAUGE 1-1/2" BRAD NAIL
18114	18 GAUGE 1-1/4" BRAD NAIL

ADDITIONAL SIZES AVAILABLE



GALVANIZED LONG STAPLES	
9028	1 1/8" STAPLE 1/4" CR.
9032	18 GAUGE 1 1/4" CR.

ADDITIONAL SIZES AVAILABLE



CAM AND DOWEL	
MM0201ES37A1	12 mm H X 15 mm D Cam
MM1802ES37A2	42 mm Dowel Bolt



SHORT STAPLES	
8-12	21 GAUGE 7/16" CROWN X 1/2" LONG
8-14	21 GAUGE 7/16" CROWN X 9/16" LONG
9012	18 GAUGE 1/4" CROWN X 1/2" LONG

ADDITIONAL SIZES AVAILABLE



NAILS	
14461	1-1/4 in 16 GAUGE NAILS
14471	1- 1/2 in 16 GAUGE NAILS

STAPLES	
17145	1/4 in. x 1/4" CROWN STAPLES GALVANIZED
17132	1- 3/4in 16 GALVANIZED

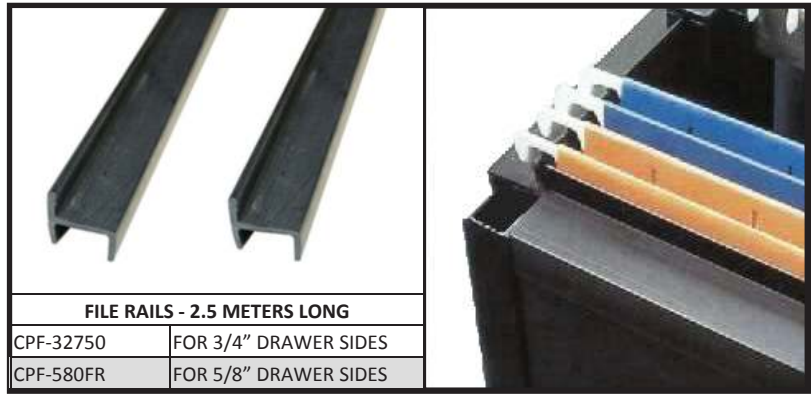
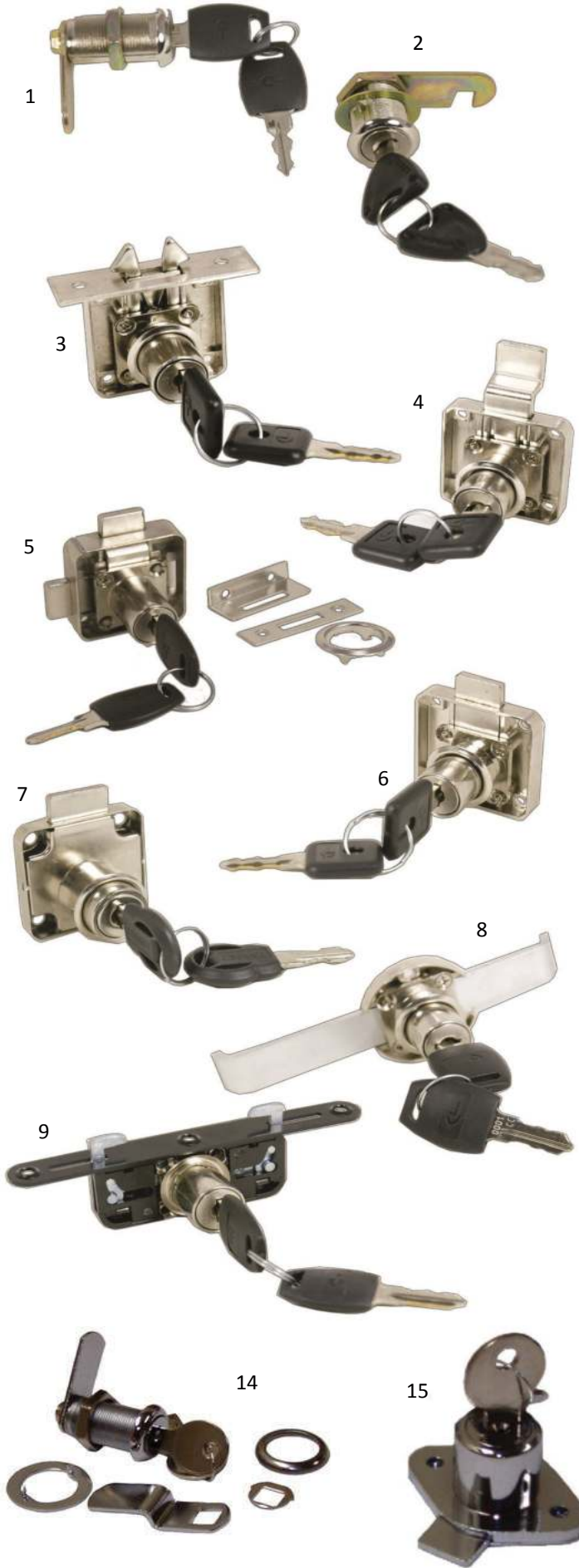

LOCKS AND CAMS						
	CODE	TYPE	DIAM.	KEY	COMBO	CORE
1	MM103CCM25A	1-1/8" CAM LOCK	30MM	DIFF.	1000	REMOVABLE
	MM103CCM25B			ALIKE		
2	MM0880CM25A	1-1/8" CAM LOCK	30MM	DIFF.	240	NOT REMOVABLE
	MM0880CM25B			ALIKE		
3	MM0605CM25A	MORTISE LOCK	18MM	DIFF.	1000	REMOVABLE
4	MM0128CM25A	DRAWER LOCK	22MM	DIFF.	1000	REMOVABLE
5	MM0628CM25A	DOUBLE DRAWER LOCK	18MM	DIFF.	1000	REMOVABLE
	MM0628CM25B			ALIKE		
6	MM0126CM25A	DRAWER LOCK	18MM	DIFF.	1000	REMOVABLE
	MM0126CM25B			ALIKE		
7	MM9001CM25B	DRAWER LOCK	18MM	ALIKE	240	NOT REM.
8	MM0127CM25A	DOUBLE DRAWER LOCK	18MM	DIFF.	1000	REMOVABLE
	MM0127CM25B			ALIKE		
9	MM0637CM25A	SLIDING DOOR LOCK	18MM	DIFF.	1000	REMOVABLE
	MM0637CM25B			ALIKE		
10	MM0C14CM25A	23MM CAM				
11	MM0C06CM25A	10MM CAM				
12	MM0041CM25A	L-BRACKET FOR LOCKS				
13	MM6036CM25A	3 DRAWER LOCK 600MM BAR	18MM	DIFF.	1000	REMOVABLE
	MM6036CM25B			ALIKE		
14	MM0701LC25A	1-1/8" CAM LOCK		ALIKE		NOT REM.
15	MM0702LC25A	DRAWER LOCK		ALIKE		NOT REM.

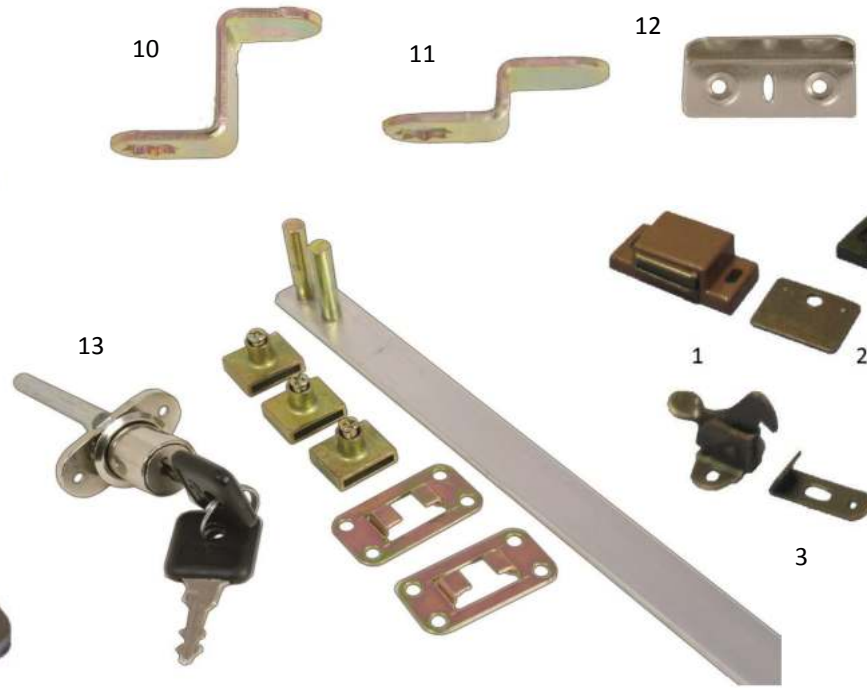



601S



614L



649R



731V



1-170-03-DU005-16



1-171-04-DU091-16



1-174-03-G016-16



189-L1



191



198-W1



199-L



LOCKS AND CATCHES				
	CODE	TYPE	DIAM.	KEY
1	7910-20BL-D	CABINET LOCK	22MM	ALIKE
2	7910-20CR-B	CABINET LOCK	22MM	DIFF.
3	3310-24/SN	CABINET LOCK	45MM	
4	7810-24BL	CABINET LOCK	35MM	
5	2200QL-24	CABINET LOCK	55MM	
6	2550-24-DN	CABINET LOCK	48MM	
7	8810-24MK	CABINET LOCK	59MM	
8	MC-159-2-ST	MAGNETIC CATCH		
9	BCTS-85J	TENSION CATCH		
10	MC-JM38BL	MAGNETIC CATCH	38MM	



ELECTRIC GROMMET

MP8825LC02B
 63MM DRILLING DIAMETER GROMMET
 - POWER ADAPTOR
 - POWER / USB / HDMI - SOCKETS
 - POWER / USB / HDMI - CABLES

POWER SOCKET
 USB TYPE-A
 HDMI

UL ADAPTOR
 5V / 2.1A

USB CABLE - (1M)

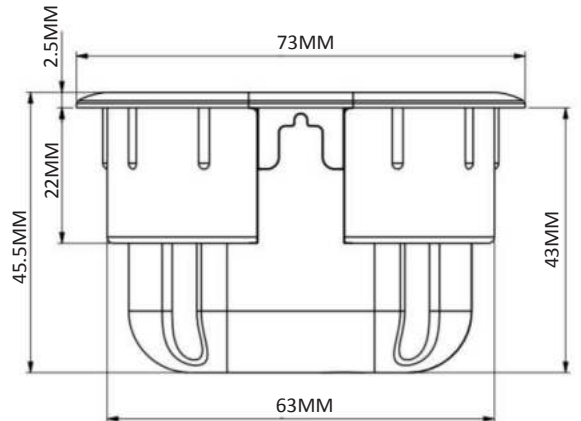

HDMI CABLE - (1.5M)

UL POWER PORT CABLE SUPPLIES:
 AC 120V / 10A - (1.5M)

24V PLUG IN POWER SUPPLY
 T-24V-PI

2F LINKING CABLE 120V BAR LIGHT
 L-BL-LC-02

60 WATT IR WAVE SENSOR SWITCH
 T-WSS-60W-IR

120V BAR LIGHT (BLACK)
 L-BL12-TW

9.5ft cable

Top View

POWER BAR WITH 2 USB AND 2 PLUG POINTS (SIDE CORD)
 MM7400-02A

72V DOPPLER SENSOR SWITCH
 T-MSS-D-TS



CABLE METAL GROMMET (WHITE)
LS50F-WT
50 × 50 × 13.6 MM



SPLIT CABLE GROMMET
LS-50S-S-SN



SPLIT CABLE GROMMET
CHC-S26GC



CABLE GROMMET (BLACK)
V60/BLK
72 × 25 MM



GROMMET SET UNASSEMBLED
MB16327WB02A



BLACK PLASTIC GROMMET 64MM DIA.
MP3000LC02A



BLACK PLASTIC GROMMET 40MM DIA.
MP2000LC02A



BLACK PLATIC GROMMET w SPRING 60MM DIA.
MPF924DV02A



STAINLESS STEEL GROMMET
1283BLK
5MM (BLACK)



STAINLESS STEEL GROMMET
1284PB
7MM (POLISHED BRASS)



SPRING CLOSURE GROMMET
69000WH
75MM (WHITE)

hardware
resources



REAR MOUNTING BRACKET
303FUSFT2



FRONT MOUNTING BRACKET
303FU4



ZINC PLATED HEAVY DUTY BRACKET
5460-12
12" LENGTH

SUGATSUNE



LEVER RELEASE BRACKET
EB-1000-2



ALUMINUM FOLDING BRACKET
38820-25



STAINLESS STEEL BRACKET
BOS-180



PARROT SHELF SUPPORT
MM6853ES25A | ADJ. SUPPORT WITH 5MM PIN

OVAL HOLE AVAILABLE

SHELF SUPPORTS AND BRACKETS



SHELF SUPPORT & BRACKETS				
1	MP607AAN15B	5/8" CLEAR SHELF SUPPORT WITH 5MMD PIN	14	MM5006QU31A 3/4" X 3/4" X 3/4" METAL BRACKET
2	MP607AAN34B	5/8" WHITE SHELF SUPPORT WITH 5MMD PIN	15	M5002QU31R 5/8" X 5/8" X 1/2" ROUND HOLE BRACKET
3	MML514LC37D	5MMD ZINC PLATED SHELF SUPPORT	16	MM2525AN37A 2-1/2" X 2-1/2" X 1/2" ANGLE BRACKET
4	MML514LC02D	5MMD BLACK OXIDE SHELF SUPPORT	17	MM9474CM31A 4" X 5/8" MENDING PLATE
5	MB5143LC37A	5MMD SHELF SUPP. WITH CLEAR PVC CUSHION	18	MM5012LA31A 2" X 1/2" MENDING PLATE
6	MM5144LC25A	5MMD NICKEL SHELF SUPPORT	19	MM0256KV37A ZINC PLATED PILASTER CLIP
7	MB8001LC15A	5MMD CLEAR SHELF SUPPORT	20	MM0255KV37B 8FT. ZINC PLATED PILASTER STRIP
8	MM5651CM17A	GLASS/WOOD SHELF SUPPORT 75MM	21	MM5004AN02A 1 x 1 x 1 3/4" 4 HOLE BLACK BRACKET
9	MM5650SC25B	GLASS/WOOD SHELF SUPPORT 75MM, MAX 24M		
10	MP1010LC02A	BLACK PLASTIC SHELF BRACKET WITH COVER		
11	MP1010LC03A	BROWN PLASTIC SHELF BRACKET WITH COVER		
12	MP1010LC34A	WHITE PLASTIC SHELF BRACKET WITH COVER		
13	MM5004AC37A	1" X 1" X 1-3/4" 8 HOLE BRACKET		

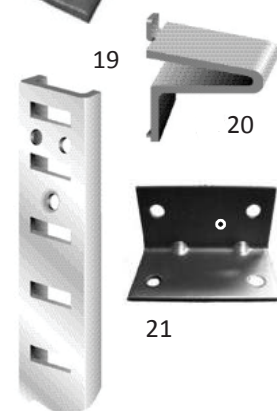



FOLDING TABLE LEGS	
MB01271F02B	CHROME, 60MM X 710MM, WITH 25MM ADJUSTMENT

FOLDING TABLE LEGS	
MB01271F02B	BLACK, 60MM X 710MM, WITH 25MM ADJ.
MB0028CM95A	STAINLESS STEEL ,60MM X 710MM, WITH 25MM ADJ.
MB0028CM25B	DULL NICKEL, 60MM X 845MM, WITH 25MM ADJ.
MB0028MA34B	WHITE, 60MM X 845MM, WITH 25MM ADJ.



CABINET LEGS AND CLIPS	
MP2210HS02A	BLACK ADJUSTABLE CABINET LEG 100MM TO 150MM EXTENSION
GZR58-03	QUICK CLIP FOR TOE KICK (SCREW ON)
MANY OTHER COMBINATION AND SIZES AVAILABLE	



MM1462-25B
105MM DULL NICKEL



MM2010-25T
110MM SATIN NICKEL



MM9210-25B
210-225MM S. NICKEL



MM9102-25B
102MM SATIN NICKEL



MB0B50-02A
50MM W. PLATE/BRAKE



MB0050-02A
50MM W. PLATE



MM2105-34A
25MM BOX CASTOR



MB6325-22A
3" GREY WITH BRAKE



MB6326-22A
3" GREY NO BRAKE

ROBERTSON COLOR CODED BITS



ROBERTSON BITS

CODE	SIZE	FINISH	CASE	CODE	SIZE	FINISH	CASE
MM5212RO14C	1 X 2"	GREEN	100	MM5223RO32C	2 X 3"	RED	50
MM5212MY31B	1 X 2"	PLAIN	100	MM5223MY31C	2 X 3"	PLAIN	50
MM5213RO14C	1 X 3"	GREEN	100	MM5224RO32B	2 X 4"	RED	50
MM5213MY31C	1 X 3"	PLAIN	100	MM5224MY31B	2 X 4"	PLAIN	50
MM5214MY31B	1 X 4"	PLAIN	100	MM5226RO32C	2 X 6"	RED	50
MM5222RO32C	2 X 2"	RED	100	MM5226MY31F	2 X 6"	PLAIN	50
MM5222MY31B	2 X 2"	PLAIN	100				



ROBERTSON 2 PIECE MAGNETIC BITS

CODE	SIZE	FINISH	CASE
MM13MGRO31A	1 X 3"	ZINC	50
MM23MGRO31A	2 X 3"	ZINC	50

ROBERTSON IMPACT BITS

CODE	SIZE	FINISH	CASE
MM12IMRO37A	1 X 2"	ZINC	100
MM14IMRO37A	1 X 4"	ZINC	100
MM22IMRO37A	2 X 2"	ZINC	100
MM24IMRO37A	2 X 4"	ZINC	100

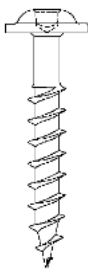
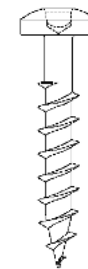
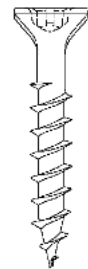
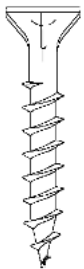

FLAT HEAD (NIBS)

FLAT HEAD (NO NIBS)

FLAT RECESS

FLAT RECESS
TYPE 17

PAN / TAPPING HEAD

ROUND WASHER

POZI DRIVES

MM5212MY31P	1 X 2" Pozi Drive Screw Bit
MM5222MY31P	2 X 2 Pozi Drive Bits Pz2
MM02PZSR31C	2 X 2-3/4" Pozi Drive Bits

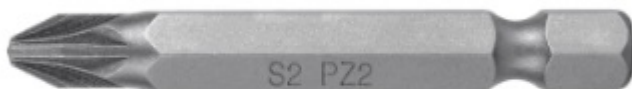

#6 FLAT HEAD WITH #2 SQUARE SOCKET, LO-ROOT, TYPE 17 WITH NIBS

CODE	SIZE	DRIVE	FINISH	CASE
MM51F6RO37I2	6 X 1-1/4"	#2 SQUARE	ZINC	8,000
MM51F6RO37K2	6 X 1-1/2"	#2 SQUARE	ZINC	7,000
MM51F6RO37M2	6 X 1-3/4"	#2 SQUARE	ZINC	5,000
MM51F6RO37N2	6 X 2"	#2 SQUARE	ZINC	4,000

FLAT RECEX, LO-ROOT, TYPE 17 MAXX SCREW

CODE	SIZE	DRIVE	FINISH	CASE
MM8100RO31B	8 X 1"	RECEX	BARE	10,000
MM8100RO37B	8 X 1"	RECEX	ZINC	10,000
MM8114RO31B	8 X 1-1/4"	RECEX	BARE	7,500
MM8114RO37B	8 X 1-1/4"	RECEX	ZINC	7,500
MM8112RO31A	8 X 1-1/2"	RECEX	BARE	5,000
MM51FHRO37K	8 X 1-1/2"	RECEX	ZINC	5,000
MM8134RO31A	8 X 1-3/4"	RECEX	BARE	4,000
MM8134RO37A	8 X 1-3/4"	RECEX	ZINC	4,000
MM8200RO31A	8 X 2"	RECEX	BARE	3,500
MM8200RO37A	8 X 2"	RECEX	ZINC	3,500
MM8214RO31A	8 X 2-1/4"	RECEX	BARE	3,000
MM8214RO37A	8 X 2-1/4"	RECEX	ZINC	3,000
MM8212RO31A	8 X 2-1/2"	RECEX	BARE	2,500
MM8212RO37A	8 X 2-1/2"	RECEX	ZINC	2,500
MM8234RO31A	8 X 2-3/4"	RECEX	BARE	2,000
MM8300RO31A	8 X 3"	RECEX	BARE	1,500

#6 FLAT, LO ROOT, NO NIBS

CODE	SIZE	DRIVE	FINISH	CASE
MM0612RO37A2	6 X 1 1/2"	#2 SQUARE	ZINC	15,000
MM51F6RO37C	6 X 5/8"	#1 RECEX	ZINC	15,000
MM0658RO37A2	6 X 5/8"	#2 SQUARE	ZINC	15,000
MM0658RO37A5	6 X 5/8" (#5 HEAD)	#1 SQUARE	ZINC	15,000
MM0634RO37A2	6 X 3/4"	#2 SQUARE	ZINC	15,000
PBFS0006010000	6 X 1"	#2 SQUARE	ZINC	10,000
MM0758RO37AQ	7 X 5/8" TYPE 17	#2 RECEX	ZINC	15,000

FLAT, LO-ROOT WITH NIBS

CODE	SIZE	DRIVE	FINISH	CASE
PBFS05000508	5 X 5/8"	#1 SQUARE	ZINC	30,000
PBFS06000508	6 X 5/8"	#1 SQUARE	ZINC	15,000
PBFS06010000	6 X 1"	#1 SQUARE	ZINC	10,000
PBFS06010104	6 X 1-1/4"	#1 SQUARE	ZINC	8,000
PBFS06010102	6 X 1-1/2"	#1 SQUARE	ZINC	7,000
PBFS06010304	6 X 1-3/4"	#1 SQUARE	ZINC	5,000
MM51F6CM37M	6 X 1-3/4" (#7 HEAD)	#2 SQUARE	ZINC	5,000
PBFS08000304	8 X 3/4"	#2 SQUARE	ZINC	15,000
PBFS08000708	8 X 7/8"	#2 SQUARE	ZINC	10,000
PBFS08010000	8 X 1"	#2 SQUARE	ZINC	10,000
PBFS08010108	8 X 1-1/8"	#2 SQUARE	ZINC	8,000
PBFS08010104	8 X 1-1/4"	#2 SQUARE	ZINC	7,500
PBFS08010102	8 X 1-1/2"	#2 SQUARE	ZINC	5,500
PBFS08010304	8 X 1-3/4"	#2 SQUARE	ZINC	4,000
PBFS08020000	8 X 2"	#2 SQUARE	ZINC	3,500
PBFS08020102	8 X 2-1/2"	#2 SQUARE	ZINC	2,500
PBFS08030000	8 X 3" A	#2 SQUARE	ZINC	1,500
PBFS08030102	8 X 3-1/2"	#2 SQUARE	ZINC	1,000





MACHINE SCREWS				
CODE	SIZE	DRIVE	FINISH	CASE
32BREAK - 50	8:32 X 1-3/4"	#2 PHILLIPS SLOT COMBO	ZINC	4,000
NON BREAKABLE AVAILABLE IN SIZES FROM 1/2" TO 2" IN LENGTH				



EURO SCREWS				
CODE	SIZE	DRIVE	FINISH	CASE
MM1004FG37A	6.3 X 10MM	#2 POZI	ZINC	15,000
MM1004SC37B	6.3 X 13MM	#2 POZI	ZINC	15,000



FLAT TOP PAN RECEX, FRAMELOCK, PILOT SCREW				
CODE	SIZE	DRIVE	FINISH	CASE
MM51P7RO31I	7 X 1-1/4"	#2 SQUARE	BARE	7,500
MM51P7RO31K	7 X 1-1/2"	#2 SQUARE	BARE	6,000



MODIFIED TRUSS RECEX, EXTRA LARGE WASHER, TYPE 17 LO ROOT				
CODE	SIZE	DRIVE	FINISH	CASE
MM8118RO37A1	8-10 X 1-1/8"	#2 RECEX	ZINC	10,000



TAPPING SCREWS				
CODE	SIZE	DRIVE	FINISH	CASE
TAPS06000308B	6 X 3/8"	#1 SQUARE	BARE	20,000
TAPS06000716	6 X 7/16"	#1 SQUARE	ZINC	20,000
TAPS06000508	6 X 5/8"	#1 SQUARE	ZINC	15,000
TAPS08000916	8 X 9/16"	#2 SQUARE	ZINC	12,000
TAPS08000508	8 X 5/8"	#2 RECEX	ZINC	12,000
TAPS08000304	8 X 3/4"	#2 SQUARE	ZINCE	10,000
TAPS08010000	8 X 1"	#2 SQUARE	ZINCE	8,000
TAPS08010102	8 X 1-1/2"	#2 SQUARE	ZINCE	5,000
TAPS08010304	8 X 1-3/4"	#2 SQUARE	ZINCE	4,500
TAPS08030000	8 X 3"	#2 SQUARE	ZINCE	1,500



ROUND WASHER, LO ROOT				
CODE	SIZE	DRIVE	FINISH	CASE
PBRWS08000508	8 X 5/8" TYPE 17	#2 SQUARE	ZINC	12,000
MMW817RO37G	8 X 1" TYPE 17	#2 SQUARE	ZINC	8,000
MMW817RO37G1	8 X 1"	#2 SQUARE	ZINC	8,000
PBRWS06010108	6 X 1-1/8"	#1 SQUARE	ZINC	
PBRWS08010108	8 X 1-1/8" TYPE 17	#2 SQUARE	ZINC	6,000
PBRWS08010104	8 X 1-1/4" TYPE 17	#2 SQUARE	ZINC	6,000
PBRWQ08010104	8 X 1-1/4" TYPE 17	#2 RECEX	ZINC	6,000
PBRWS08010102	8 X 1-1/2" TYPE 17	#2 SQUARE	ZINC	5,000
MM51W8RO37M	8 X 1-3/4"	#2 SQUARE	ZINC	4,000
MM51W8RO37N	8 X 2"	#2 SQUARE	ZINC	3,000
PBRWS08020102	8 X 2-1/2" TYPE 17	#2 SQUARE	ZINC	2,500
PBRWQ08030000	8 X 3" TYPE 17	#2 SQUARE	ZINC	1,500

SINKS



Available in
20 models and
5 colours

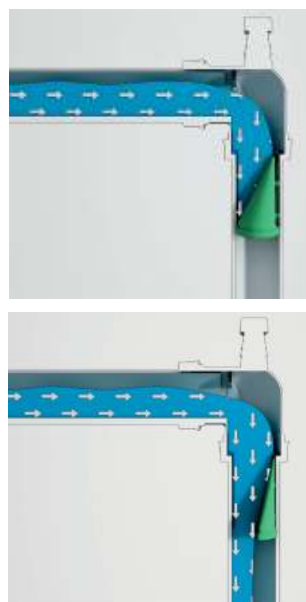

Panama Canal Section
The Panama Siphon is named after the Panama Canal, which connects the Caribbean Sea with the Pacific Ocean. The Panama Canal is very important, as it shortens the distance required saving the trip around South America. With the Panama Siphon there is no need for a detour, the water flows directly from the sink to the sewer.

GAS BURNERS



Gas Burners

- Albany
- Allegheny
- American
- Ashley
- Back
- Baker
- Barrington
- Boundary
- Brazos
- Churchill
- Colorado
- Columbia
- Connecticut
- Delaware
- Delta
- Detroit
- East
- Eastmain
- Edisto
- Fraser

INDUCTION BURNERS



Induction Burners

- Denali
- Ranier
- Rushmore

OUTDOOR COMFORT

More than a cabinet. This is a functional and adaptable storage system with high quality material. Choose from selected accessories in order to maximize the functionality of your outdoor kitchen.

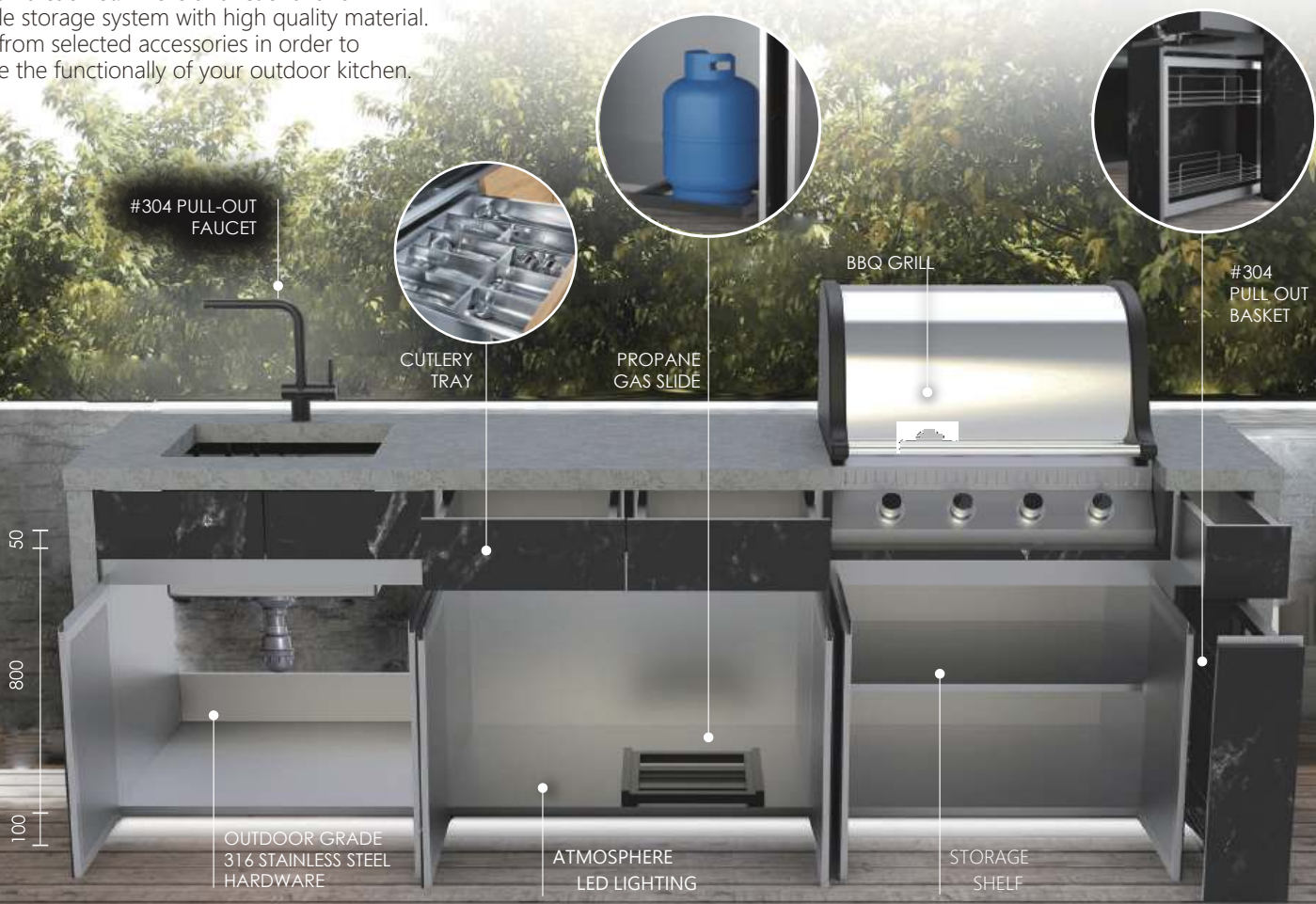

Framework



SLATE COVER

SOLID ALUMINUM FRAME

316 STAINLESS STEEL FOUNDATION

System



200/250mm

W 200/250mm
D 650mm
H 800mm



800mm

W 800mm
D 650mm
H 660mm



600mm

W 600mm
D 650mm
H 800mm

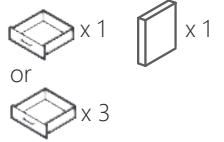

900mm

W 900mm
D 650mm
H 800mm



GARAGE STORAGE

WALL UNIT

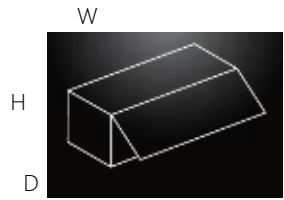

H Min.680mm
D Min.330mm
W Min.300mm

ROLLER SHUTTER

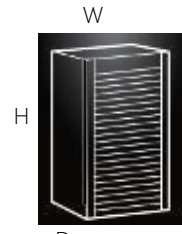

H Min.500mm
D Min.450mm
W Customized

BASE UNIT

**Could be Door/Drawer*

TALL UNIT

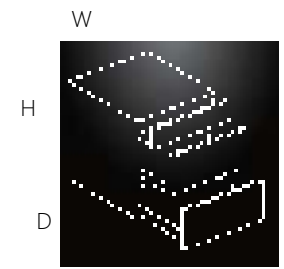

H Min. 680mm
D Min. 550mm
W Min. 300mm



H Min.1520mm
D Min.550mm
W Min.400mm



COUNTER TOP

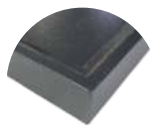

Sandwich Panel
 Anit-Corrosion

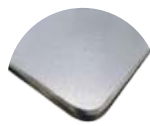

#304 Stainless Steel
 Anti-Scratch
 6mm or 10mm Thickness

Assembly Variation



H D W
 2200mm x 550mm x 1900mm



H D W
 2000mm x 550mm x 2300mm



H D W
 2000mm x 550mm x 2300mm



Each kit contains:

- M140 Hose (12')
- M120 Gun
- Tensor Wrench
- Carabiner



GLUE EXTRAS	
M120	SPRAY GUN
M125	WAND GUN
M130-12	12FT FLEXIBLE HOSE
M130-25	25FT FLEXIBLE HOSE
M140-25	25FT TEFLON HOSE
M150-12	12FT STAINLESS STEEL HOSE

AEROSOL CLEANER	
S101AA	AEROSOL CITRUS CLEANER SOLVENT
P307-AA	CONTACT ADHESIVE LOW VOC 650ML
P329-AA	SENSORGRIP CA PRESSURE FOAM ADHESIVE
P302-AA	CLEAR CONTACT ADHESIVE LOW VOC650ML

CONTACT ADHESIVE																		
CODE	PACKING	HI TEMP RES.	SPRAY TYPE	LONG BOND TIME	PSA	COLD APP	WOOD	HPL	HIGH GLOSS	POST FORM	METAL	POLY FOAM	FOAM FLEX FABRIC	VINYL	RUBBER	PLASTIC	HAPS COMP	CA VOC
P300	22L, 108L, 216L	MILD	WEB	SUG.		YES	HR	HR			R		R					
P302	22L, 108L, 216L	YES	WEB	SUG.		YES	HR	HR			R		R					
P307	22L, 108L, 216L	MILD	WEB	SUG.		YES	HR	HR			R		HR		R	R	YES	YES
P308	22L, 108L, 216L	YES	WEB	SUG.		YES	HR	R			HR	R	HR	R	R	R	YES	YES
P313	22L, 108L, 216L	MILD	PEB.				HR	HR	R	R	R						NO	YES
P323	22L, 108L, 216L	YES	WEB		YES							HR		R	R	R	YES	
P331	22L, 108L, 216L	MILD	WEB									HR		R			YES	
P809	22L, 108L, 216L	YES	WEB				HR	R	HR			R	R	HR	HR	HR		YES
		HR	HIGHLY RECOMMENDED					R	RECOMMENDED				SUG.	SUGGESTED USE				

SILICONE SEALANTS / SCELLANTS AU SILICONE

Soudasil K&B



Soudasil MULTI



Soudasil RTV3



Soudasil HT1



ACCESSORIES / ACCESSOIRES

Soudal Swipex



Soudal Gun & Foam Cleaner
Nettoyant à Pistolet et Mousse



■ Soudasil K&B is a premium, mildew resistant **100% RTV silicone**.

- Permanently flexible
- Easy to apply
- Excellent adhesion to glass, ceramic, porcelain, metals, wood & many more
- Mildew resistant
- UV resistant
- NSF/FDA compliant
- VOC compliant

■ Soudasil MULTI is a general purpose, mildew resistant **multi-purpose RTV silicone**.

- Permanently flexible
- Easy to apply
- Excellent adhesion to glass, ceramic, porcelain, metals, wood & many more
- Mildew resistant
- UV resistant
- VOC compliant

■ Soudasil RTV3 is a top of the line **100% RTV silicone**.

- Permanently flexible
- Easy to apply
- Excellent adhesion to glass, ceramic, porcelain, metals, wood & many more
- UV resistant
- No shrinkage
- Mildew resistant
- VOC compliant
- * NSF/FDA compliant

■ Soudasil HT1 is a **100% high temp RTV silicone**.

- Permanently flexible
- Easy to apply
- Red colored silicone
- UV resistant
- No shrinkage
- Resist temperatures up to 260°C
- VOC compliant

Guns / Pistolets



■ Soudal Skeleton Gun 300 mL Cartridge
■ Pistolet à cartouche 300 mL à cadre parallèle



■ Soudal Designer Gun is a top of the line metal gun foam applicator
■ Le pistolet Soudal "Designer" est un pistolet en métal haut de gamme pour application de la mousse



■ Soudal Compact Gun is a plastic gun foam applicator
■ Le pistolet Soudal "Compact" est un pistolet en plastique pour application de la mousse



■ Heavy Duty Skeleton Gun, 300 mL Cartridge
■ Pistolet à Cartouche Robuste 300 mL à cadre parallèle

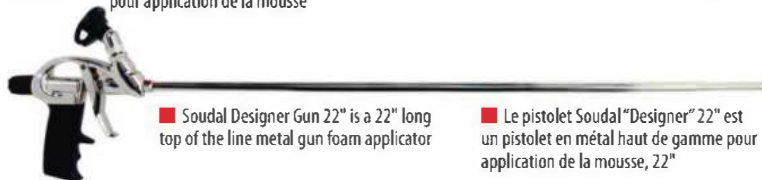

■ Soudal Designer Gun 22" is a 22" long top of the line metal gun foam applicator

■ Le pistolet Soudal "Designer" 22" est un pistolet en métal haut de gamme pour application de la mousse, 22"



■ Soudal Designer Gun 40" is a 40" long top of the line metal gun foam applicator

■ Le pistolet Soudal "Designer" 40" est un pistolet en métal haut de gamme pour application de la mousse, 40"



■ Manuel gun with 2 barrels for 600 mL sausages
■ Pistolet manuel avec 2 barils pour saucisses de 600 mL

FLEXIFOAM POLYURETHANE EXTREME FLEXIBLE FOAM INSULATION

Ideal where a foam with extreme elasticity is needed

- Minimal Expansion Foam
- Very High Elastic Recovery
- Extreme Weather Formulation
- Gunable in All Seasons (-25°C to 49°C with a Can Temperature of 4°C to 35°C)
- 2 Year Shelf Life
- Storage in All Positions
- Excellent Thermal and Acoustical Insulation
- Closed Cell Foam: Airtight and Weather-tight Seal
- Installs 5x Faster Than Fiberglass
- Has an R-value per Inch of R-6.5 Compared to R-3.14 for Traditional Fiberglass
- No Shrinkage

AEROSOL CAN 750ML



SOUDAFOAM DOOR & WINDOW POLYURETHANE FOAM INSULATION

Ideal for eliminating thermal bridges between window frame and construction

- Minimal Expansion Foam
- Professional Gun Grade
- Excellent Thermal and Acoustic Insulation Properties
- Closed Cell Foam: Airtight and Weather-tight Seal
- Installs 5x Faster Than Fiberglass
- Has an R-value per Inch of R-6.5 Compared to R-3.14 for Traditional Fiberglass
- AAMA Certified

AEROSOL CAN 750ML (GUN),
GENIUS GUN 600ML (GENIUS GUN).



SOUDAFOAM ALL SEASON POLYURETHANE EXTREME WEATHER FOAM

Top of the line, minimal expansion foam for use in extreme climates

- Minimal Expansion Foam
- Extreme Weather Formulation
- High Yield
- Gunable in All Seasons (-25°C to 49°C With a Can Temperature of 4°C to 35°C)
- Excellent Thermal and Acoustical Insulation
- Closed Cell Foam: Airtight and Weather-tight Seal
- Installs 5x Faster Than Fiberglass
- Has an R-value per Inch of R-6.5 Compared to R-3.14 for Traditional Fiberglass
- No Shrinkage
- AAMA Certified

AEROSOL CAN 750ML (GUN),
600ML (GUN), 600ML (GENIUS).



SILIRUB 2 ONE PART, NEUTRAL CURE SILICONE SEALANT

Ideal for window glazing as well as window and door installations

- Excellent Adherence to PVC-Vinyl, Glass, Metals and Wood
- Permanent Flexibility and Excellent Recovery: +/- 25% movement
- Excellent UV Resistance, Color Stability and Weatherability
- Colors: White, Clear (for others colors, please contact your sale rep)
- Low Odor / VOC Compliant: Low VOC <3%

300ML CARTRIDGE



SOUDASEAL AP ALL PURPOSE SMX®-POLYMER HYBRID SEALANT & ADHESIVE

Ideal for sealing of windows & doors, both interior and exterior
Next Generation Sealant:

- Features Superior Performance Characteristics
- Superior Weather Resistance: Waterproof. Can be Applied to Damp Surfaces
- Paintable (Water Base Paint). Prior Testing Required
- Colors: White, Off White, Tan, Stone, Limestone, Aluminum Gray, Gray, Medium Bronze, Special
- Bronze, Black, Redwood, Hunter Green
- Permanent Flexibility and Elasticity: +/-35% Movement
- Excellent Adherence to Porous and Non Porous Substrates: PVC-Vinyl, Wood, Glass, Metal, Concrete, Stone and Flashing Tape. No Need for Primers
- No Shrink, No Smell, No Bubbbling, Easy to Tool and Finish
- Environmentally Friendly: No Isocyanates/No Solvents
- Low Temperature Workability. Will Not Freeze and Easy to Extrude
- VOC Compliant: Low VOC Level: <3% VOC
- Plastic Cartridge
- AAMA Certified

300ML CARTRIDGE, 600ML SAUSAGE



SOUDACRYL LTX1 SILICONIZED LATEX ACRYLIC

Ideal for interior sealing of windows & doors
High Quality Siliconized Acrylic Sealant

- Plasto-Elastic
- Paintable
- Colors: White, Almond, Bronze, Brown, Grey, Cedar & Clear
- Odorless
- UV and Weather Resistant
- Used for Sealing of Low Stressed Joints and Cracks
- Meets or Exceeds ASTM C-834

300ML CARTRIDGE



HOT MELT PELLETS AND CARTRIDGES

EGP210PP38A	NATURAL CARTRIDGE 16KG (180-200°)	EGP600PP38A	NATURAL PELLETS 20KG (180-200°)
EGP280PP15A	CLEAR PELLETS 20KG (180-200°)	EGPHM2200NT25	NATURAL PELLETS 25KG (180-200°)
EGP600PP15A	CLEAR PELLETS 20KG (130-140°)	EGPDR2004WHT	WHITE PELLETS 25KG (180-200°)

PROFESSIONAL FAST ADHESIVE KIT

MG705-200	200MML AEROSOL & ACTIVATOR
MG705-400	400MML AEROSOL & ACTIVATOR

HOUSEHOLD / AUTO & TOOL KIT



SANDPAPER & ACCESSORIES



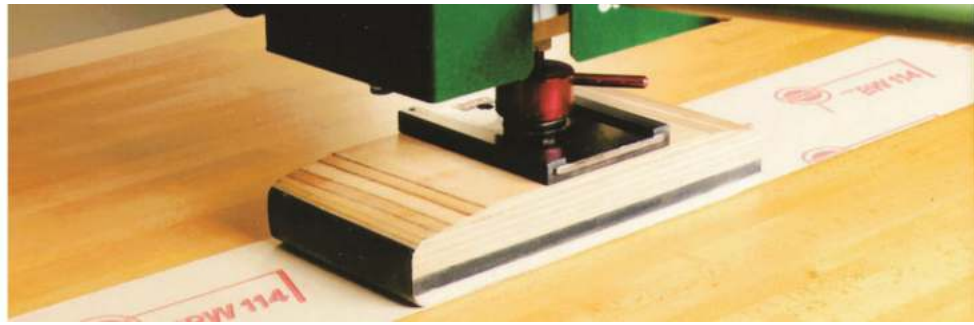

PORTABLE BELTS

CODE	SIZE	GRIT	CODE	SIZE	GRIT	CODE	SIZE	GRIT
MA0321HR22A	3" X 21"	60	MA0648HR22A	6" X 48"	60	MA6158HR22C	6" X 158"	100
MA0321HR22B	3" X 21"	80	MA0648HR22B	6" X 48"	80	MA6240HR22B	6" X 168"	80
MA0321HR22C	3" X 21"	100	MA0648HR22C	6" X 48"	100	MA6264HR22A	6" X 240"	100
MA0321HR22D	3" X 21"	120	MA0648HR22D	6" X 48"	120	MA6290HR22B	6" X 264"	80
MA0324HR22A	3" X 24"	60	MA0680HR22B	6" X 80"	80	MA6290HR22D	6" X 290"	120
MA0324HR22B	3" X 24"	80	MA0680HR22C	6" X 80"	100	MA6290HR22E	6" X 290"	150
MA0324HR22C	3" X 24"	100	MA0690HR22B	6" X 90"	100	MA6306HR22A	6" X 290"	80
MA0324HR22D	3" X 24"	120	MA6108HR22B	6" X 108"	80	MA6306HR22B	6" X 306"	100
MA0424HR22A	4" X 24"	60	MA6108HR22D	6" X 108"	120	MA6306HR22C	6" X 306"	120
MA0424HR22B	4" X 24"	80	MA6108HR22E	6" X 108"	150	MA6306HR22D	6" X 306"	150
MA0424HR22C	4" X 24"	100	MA6128HR22C	6" X 128"	100	MA6315HR22B	6" X 315"	100
MA0424HR22D	4" X 24"	120	MA6158HR22A	6" X 158"	60	MA6315HR22C	6" X 315"	120
MA0424HR22E	4" X 24"	150	MA6158HR22B	6" X 158"	80			



SANDING SHEETS

CODE	SIZE	GRIT
MA9060HR22A	9" X 11"	60
MA9080HR22A	9" X 11"	80
MA9100HR22A	9" X 11"	100
MA9120HR22A	9" X 11"	120
MA9150HR22A	9" X 11"	150
MA9180HR22A	9" X 11"	180
MA9220HR22A	9" X 11"	220
MA9280HR22A	9" X 11"	280
MA9320HR22A	9" X 11"	320
MA9400HR22A	9" X 11"	400

SANDING SPONGES

CODE	SIZE	SIDE	GRIT
MF4555HR22A	4-1/2" X 5-1/2" X 3/16"	1	100
MF4555HR22B	4-1/2" X 5-1/2" X 3/16"	1	180
MF4555HR22C	4-1/2" X 5-1/2" X 3/16"	1	220
MF4556HR22C	3-7/8" X 4-7/8" X 1/2"	2	220
MF4557HR22B	2-3/4" X 4" X 1"	4	100
MF4557HR22C	2-3/4" X 4" X 1"	4	180
MF4557HR22D	2-3/4" X 4" X 1"	4	220

SANDING DISCS				
CODE	DIA.	# OF HOLES	BACKING	GRIT
MA0VC5HR22A	5"	NONE	VELCRO	60
MA0VC5HR22B	5"	NONE	VELCRO	80
MA0VC5HR22C	5"	NONE	VELCRO	100
MA0VC5HR22D	5"	NONE	VELCRO	120
MA0VC5HR22E	5"	NONE	VELCRO	150
MA0VC5HR22F	5"	NONE	VELCRO	180
MA0VC5HR22H	5"	NONE	VELCRO	220
MA0VC5HR22K	5"	NONE	VELCRO	320
MA0VC5HR22L	5"	NONE	VELCRO	400
MA0VC5HR22M	5"	NONE	VELCRO	500
MA5VC5HR22A	5"	5 HOLES	VELCRO	60
MA5VC5HR22B	5"	5 HOLES	VELCRO	80
MA5VC5HR22C	5"	5 HOLES	VELCRO	100
MA5VC5HR22D	5"	5 HOLES	VELCRO	120
MA5VC5HR22E	5"	5 HOLES	VELCRO	150
MA5VC5HR22F	5"	5 HOLES	VELCRO	180
MA5VC5HR22G	5"	5 HOLES	VELCRO	220
MA5VC5HR22K	5"	5 HOLES	VELCRO	320
MA8VC5HR22A	5"	8 HOLES	VELCRO	60
MA8VC5HR22B	5"	8 HOLES	VELCRO	80
MA8VC5HR22C	5"	8 HOLES	VELCRO	100
MA8VC5HR22D	5"	8 HOLES	VELCRO	120
MA8VC5HR22E	5"	8 HOLES	VELCRO	150
MA8VC5HR22F	5"	8 HOLES	VELCRO	180
MA8VC5HR22G	5"	8 HOLES	VELCRO	220
MA8VC5HR22K	5"	8 HOLES	VELCRO	320
MA8VC5HR22L	5"	8 HOLES	VELCRO	400



SANDING DISCS				
CODE	DIA.	# OF HOLES	BACKING	GRIT
MA0VC6HR22A	6"		VELCRO	60
MA0VC6HR22B	6"	NONE	VELCRO	80
MA0VC6HR22C	6"	NONE	VELCRO	100
MA0VC6HR22D	6"	NONE	VELCRO	120
MA0VC6HR22E	6"	NONE	VELCRO	150
MA0VC6HR22F	6"	NONE	VELCRO	180
MA0VC6HR22G	6"	NONE	VELCRO	220
MA0VC6HR22I	6"	NONE	VELCRO	240
MA0VC6HR22K	6"	NONE	VELCRO	320
MA0VC6HR22L	6"	NONE	VELCRO	400
MA6VC6HR22A	6"	6 HOLES	VELCRO	60
MA6VC6HR22B	6"	6 HOLES	VELCRO	80
MA6VC6HR22C	6"	6 HOLES	VELCRO	100
MA6VC6HR22D	6"	6 HOLES	VELCRO	120
MA6VC6HR22E	6"	6 HOLES	VELCRO	150
MA6VC6HR22F	6"	6 HOLES	VELCRO	180
MA6VC6HR22G	6"	6 HOLES	VELCRO	220



BACKUP PADS FOR SANDERS			
CODE	DIA.	# OF HOLES	BACKING
MA0VP5HR22A	5"	NONE	VELCRO
MA0VP6HR22A	6"	NONE	VELCRO

BACKUP PADS FOR SANDERS			
CODE	SIZE	SIDES	GRIT
MFC135HR22A	4-1/2" X 5-1/2"	1	180
MFC135HR22B	4-1/2" X 5-1/2"	1	240
MFC135HR22D	4-1/2" X 5-1/2"	1	320



MBJTWDCM34A
T-shirt Wiping Rags
No Seams, White, 10lbs



MP1401HL15A
Clear Stretch Wrap
450 m



MB0BXWCM34A-10
T-shirt Wiping Rags
Seams, White, 10lbs



MP2132CM15A
2" Packaging Tape
Clear, 48mm x 132m



MP1041HL15A
5" X 1000' Clear Stretch Wrap



MS0220CM01A
1" Masking Tape
Beige, 24mm x 55m



MS0224CM01A
2" Masking Tape
Beige, 48mm x 55m



MS3655CM14A
1.5" Premium Green Masking Tape
36mm x 55m



MS0222CM14A
1.5" Green Masking Tape
36mm x 55m



MGDST1825
Double Sided Tape
18 mm X 25 m

MGDST2425
Double Sided Tape
24 mm X 25 m

PLAN & ELEVATIONS

The CabMaster Designer Software range includes the ability to create Plan and Elevation Views.

This means that you can create multiple elevations per drawing and even per cabinet.

These elevations can also be enlarged to show more precise detail.

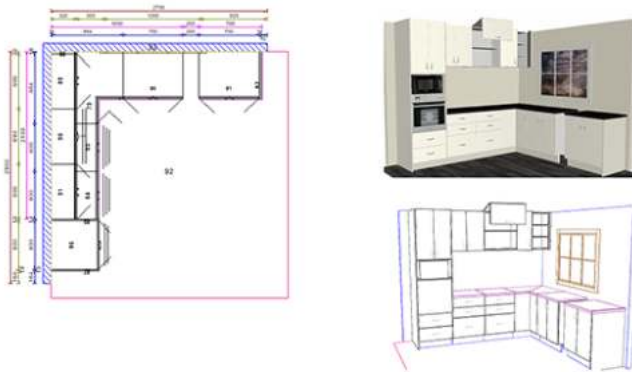
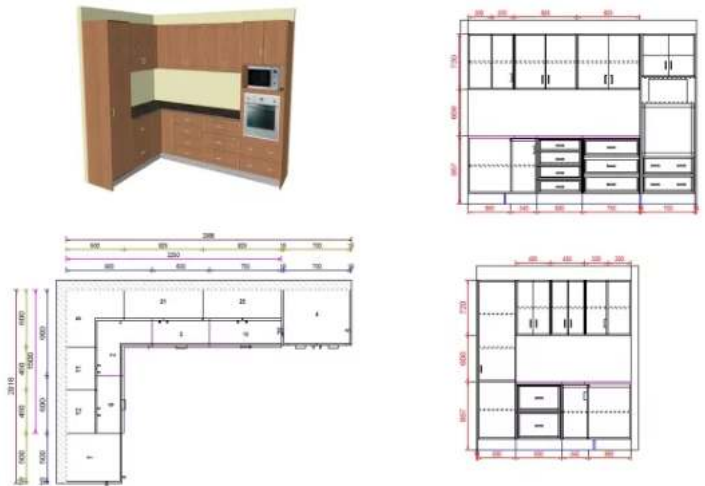

PERSONALIZED TEMPLATES

Using CabMaster Software Designer products, you can create multiple personalized templates to suit your specific needs.

You can customize everything from simply your page size and company logo, to runner types and materials required.

Your template details can also include job number, customer details and a sign off section.

3D RENDER

A simple 3D rendered view is included in CabMaster Designer Software.

In addition, an Advanced "Photoview" option is also available.

With Photoview you can create high quality 3D renders, therefore giving you an edge in design visualization.



ORDERING

- ⇒ Website: www.canmade.com
- ⇒ Phone: T - (800) 668-7636 | L - (905) 738-8886
- ⇒ Fax: (905) 738-0864
- ⇒ Email: cnmdtor@canmade.com
- ⇒ Customer Service is available from 7:30am until 4:30pm Eastern Time
- ⇒ \$25.00 Minimum Order unless purchasing item on back order or Online purchase
- ⇒ Will Call Orders available for pick up from 8:00am until 4:00pm, local warehouse time

The Canmade website allows you to place orders, view item pictures and view catalog's of our Brand Suppliers for additional options.

RETURNS

All requests for returns must be made within 20 days of invoice date. Returns are subject to a 20% restocking fee unless the return is due to Canmade's error or a quality issue.

To request a Return Goods Authorization contact Customer Service.

- ⇒ Phone: T - (800) 668-7636 | L - (905) 738-8886
- ⇒ Fax: (905) 738-0864
- ⇒ Email: cnmdtor@canmade.com
- ⇒ Include the Item Number, Quantity and reason for return when requesting an RGA

Items should be in original packaging and shipped with care to avoid damage. Items received damaged may not be credited.

In the event that the return is due to an error by Canmade, return shipping instructions and cost will be covered by Canmade. Otherwise, shipments are the Customer's responsibility and should be via a method which allows shipment tracking and proof of delivery.

SOURCING

At Canmade we specialize in sourcing new products or products you want to develop. In many cases, we may even have it.

Some special orders require an upfront payment or deposit. Every order request is different.

If you did not see it in our catalog, please ask, as we are confident we can help.

Don't see it?...

Ask us!!!

A BRIEF SNIPPET

Canmade is a North American leader in the supply of specialty hardware. We hold our relationships with our suppliers and customers in high esteem which is why we have more than 40 years of experience under our belt.

We started out small, but over the years we have been importing and distributing functional and decorative hardware for the kitchen, bath, office and ready-to-assemble furniture industries. Our inventory currently boasts over 35,000 products including: adhesives, handles and knobs, lighting, slides and hinges, decorative surfaces, and organisation solutions. We are also conveniently located in Toronto, Montréal and will be growing across Canada and the United States.

Essentially, we strive to be the wholesaler you can rely on for all your furniture hardware needs with ease across North America.

WHAT WE VALUE

Relationships

Community

Integrity

Loyalty

Knowledge

Quality

Style

MISSION

Our mission is to build lasting relationships with our customers by offering sound and helpful advice, reliable service, great prices, alternatives and easy order processing.

VISION

We strive to be the heart and soul of the woodworking, renovation, interior design, and furniture design industries by helping small and mid-sized businesses grow and flourish through our mode of services and pricing. Our vision is to become the leading North American organization in our industry for customer service, advice, reliability, affordability and options.

